

## **Installation and connection instructions**



**General information:**

**SYCLOPE Electronique 2020®** Manual of 13.11.2020 Rev 1

Analysers/Controllers for swimming pools  
**Product line ODI TOUCH®**

Installation and connection instructions ODT1211 (Ref : DOC0XXX)

Editor:



**SYCLOPE Electronique S.A.S.**

Z.I. Aérople Pyrénées  
Rue du Bruscos  
64 230 SAUVAGNON - France –  
Tel: (33) 05 59 33 70 36  
Fax: (33) 05 59 33 70 37  
Email: [syclope@syclope.fr](mailto:syclope@syclope.fr)  
Internet: <http://www.syclope.fr>

© 2020 by SYCLOPE Electronique S.A.S.  
Subject to modification

## CONTENTS

<b>I.</b>	<b>Generality</b> .....	<b>4</b>
1)	Scope .....	4
2)	Use of the <i>document</i> .....	4
3)	Symbols and signs.....	5
4)	Storage and transport.....	5
5)	Warranty .....	5
<b>II.</b>	<b>Safety and environmental instructions</b> .....	<b>6</b>
1)	Use of the equipment .....	6
2)	User obligations .....	6
3)	Risk prevention .....	6
4)	Elimination and compliance.....	7
<b>III.</b>	<b>Composition of SYCLOPE ODI TOUCH® solution</b> .....	<b>8</b>
<b>IV.</b>	<b>Installation of the SYCLOPE ODI TOUCH® solution</b> .....	<b>9</b>
1)	Installation conditions.....	9
2)	Wall installation.....	9
3)	Mounting and connections .....	10
a)	Installation and connection of the chlorine probe.....	10
b)	Installation and connection of the pH probe .....	10
<b>V.</b>	<b>Hydraulic connection of the SYCLOPE ODI TOUCH® panel</b> .....	<b>11</b>
1)	Overview .....	11
2)	Hydraulic connections.....	12
<b>VI.</b>	<b>Electrical connections of the SYCLOPE ODI TOUCH® panel</b> .....	<b>13</b>
1)	Power supply connections of the analyser .....	13
2)	Regulation outlet connections and programming .....	13
<b>VII.</b>	<b>Maintenance of the SYCLOPE ODI TOUCH panel</b> .....	<b>18</b>
1)	Replacement of the free and total chlorine probe membrane .....	18
2)	Cleaning the filter .....	19
3)	Wintering of the panel .....	19
a)	Wintering of the pH probe.....	19
b)	Wintering of the chlorine probe .....	20
<b>VIII.</b>	<b>General characteristics of SYCLOPE ODI TOUCH® panel</b> .....	<b>21</b>
<b>I.</b>	<b>Spare parts and consumables of the SYCLOPE ODI TOUCH® panel</b> .....	<b>22</b>
1)	Spare parts and consumables.....	22
2)	Consumables .....	22
<b>IX.</b>	<b>Warranty</b> .....	<b>23</b>

## I. Generality

### 1) Scope

**SYCLOPE ODI Touch**® analyser/controller you have purchased is a high-tech electronic device. It was designed and created carefully for your enjoyment and your peace of action.

Its remarkable faculty to adapt to different swimming pool structures allows it to settle in all difficult environments where mastery of water treatment is most decisive.

Thanks to HYDRO TOUCH ease of use, their user-friendliness and their remarkable technicality, you will fully enjoy its many possibilities and will be assured of a perfect control and perfect monitoring of your pool water quality.

You will find in the instructions that follow, all the information needed for the installation, use and maintenance of your new equipment.

- Installation
- Technical characteristics
- Commissioning instructions
- Safety tips

If you need more information or if you encounter problems that not have been specified in this guide, please quickly contact your retailer or SYCLOPE Electronique S.A. sales department, either at the agency or office in your area, or at technical/quality service at our head office. We will do our best to help you and make you enjoy our advice and our knowledge in the field of measurement and treatment of pools water.

Contact: [Service-technique@syclope.fr](mailto:Service-technique@syclope.fr)

### 2) Use of the document

Please read carefully the entire document before starting the installation and the commissioning of the controller device, in order to ensure the safety of swimmers, users and equipment's.

The information provided in this document must be strictly observed. **SYCLOPE Electronique S.A.S.** declines all responsibility in cases where failure to comply with the instructions of this documents.

The following symbols and pictograms will be used to facilitate reading and understanding of these instructions.

- Information
- ▶ Action to do
- Element of a list or enumeration

### 3) Symbols and signs



Risk of injury or accident. Identifies a warning concerning a potentially dangerous risk. The documentation must be consulted by the user with each time the symbol is notified. If the instructions are not respected, this presents risks of death, physical injuries or property damages.



Electric hazard. Identifies a warning statement relative to a mortal electric danger. If the instructions are not strictly respected, this implies an inevitable risk of physical injuries or death.



Risk of incorrect operation or damage for the device



Comment or particular information.



Recyclable element

### 4) Storage and transport



It is important to store and to transport the **SYCLOPE ODI TOUCH** controller in its original packaging in order to minimize risk of damage.

Furthermore, the package must be stored in an environment that is protected against humidity and exposure to chemical products.

Environmental conditions for transport and storage:

Temperature: -10 °C to 50 °C

Air humidity: Maximum of 90% without any condensation

### 5) Warranty

The warranty is provided according to the terms of our general conditions of sale and delivery as long as the following conditions are met:

- Use of the equipment according to the instructions of this notice
- No modifications of the equipment which may modify its behaviour and no incorrect manipulation
- Respect for the electrical safety conditions



Consumable material is no longer covered by warranty as soon as it's put into service

## II. Safety and environmental instructions

Please:

- Read this manual carefully before the unpacking, the installing or the commissioning of this equipment
- Take into account all the hazards and of recommended precautionary measures

The failure to respect these procedures can result in serious injury to users or damaging the device.

### 1) Use of the equipment

**SYCLOPE ODI TOUCH**<sup>®</sup> controllers has been designed to measure and control pH chlorine using appropriate sensors and actuator controls within the scope of use described in this manual.



All other uses are considered to be non-conforming and must therefore be forbidden. SYCLOPE Electronique S.A.S. will not be responsible in any case for any damage that result from such uses.

### 2) User obligations

The user undertakes not to allow its employees to work with the **SYCLOPE ODI Touch**<sup>®</sup> controller described in this manual unless they:

- Are aware of the fundamental instructions relating to work safety and prevention of accidents
- Are trained in the use of the device and its environment
- Have read and understood these instructions, warnings and manipulation rules

### 3) Risk prevention



The installation and connection of the **SYCLOPE ODI Touch**<sup>®</sup> controller should be only performed by specialized personnel and qualified for this task.  
The installation must comply with the current safety standards and instructions



Before opening the controller or manipulate the relay outputs, always remember to switch-off the primary power supply!  
Never open the controller when it is powered on!  
Maintenance operations and repairs should be only performed by trained and specialized personnel!



Take care when choosing the location for installing the controller!  
**SYCLOPE ODI Touch**<sup>®</sup> controller should not be installed in a hazardous environment and should be protected against splashing with water or chemical products. It should be installed in a dry, well-ventilated and isolated location.



Make sure that the chemical sensors used with this controller correspond well to the chemicals used. Refer to the individual technical note of each sensor. Chemistry of water is very complex, in case of doubt, contact immediately our engineering service or your approved installer/reseller.

#### 4) Elimination and compliance

Recyclable packaging of **SYCLOPE ODI TOUCH®** equipment must be disposed of according to applicable rules.



Items such as paper, cardboard, plastics or any other recyclable material must be moved to a suitable sorting centre.



According to EU Directive 2002/96/EC, this symbol indicates that from 12 August 2005, electrical appliances can no longer be disposed of in household or industrial waste. In accordance with the requirements in force, consumers within the European Union are required, from this date, to return their old equipment to the manufacturer who will take charge of their disposal without charge.



In accordance with EU Directive 2002/95/EC, this symbol indicates that the SYCLOPE ODI TOUCH® device has been designed with respect to the limitation of hazardous substances.



In accordance with the Low Voltage Directive (2006/95/EC) and the Electromagnetic Compatibility Directive (2004/108/EC), this symbol indicates that the device was designed in compliance with the above mentioned Directives.

**III. Composition of SYCLOPE ODI TOUCH® solution**

Reference	Designation	Qty	Mark
-	ODI Touch panel 74x40 pH & Free chlorine (or) 0-10ppm Cell mod. PMMA 4T	1	-
CAA2503	pH electrode without pressure Glass shaft max 0.5bars SN6+PG13,5	1	1
CAA2306	Free chlorine sensor 0-10ppm (Gold) 4..20mA	1	2
ECH0000	Sampling valve 1/2"M 5X8 Tube without filter with quick fitting	1	3
TPE0805	5x8mm pressure PE Tube (ml)	10	4
VIS1082	VBA screw, cruciform TC head 6x50	4	5
VIS1048	Nylon anchor 8x40	4	6

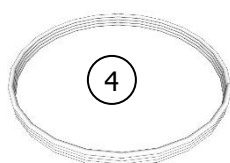
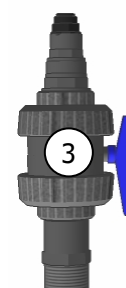



#### IV. Installation of the SYCLOPE ODI TOUCH® solution

##### 1) Installation conditions



To guarantee user safety and ensure correct operation of your **SYCLOPE TERE'O TOUCH®**, please observe the following installation instructions:

- Install the controller in a dry location
- The controller must be protected against rain, frost and direct sunlight
- The controller must be protected from splashing water or chemical products
- The room temperature must range between 0°C and 50 °C, with no condensation.
- Choose an installation location free from vibration, on a suitable support and with no deformation



If these instructions are not observed:

- The controller must be damaged
- The measurements can be disrupted
- The warranty is not applicable!

##### 2) Wall installation



Before performing the installation and electrical connections, remember to turn off the power!

- ▶ Drilling 4 holes Ø 8mm according to the following drilling plan:

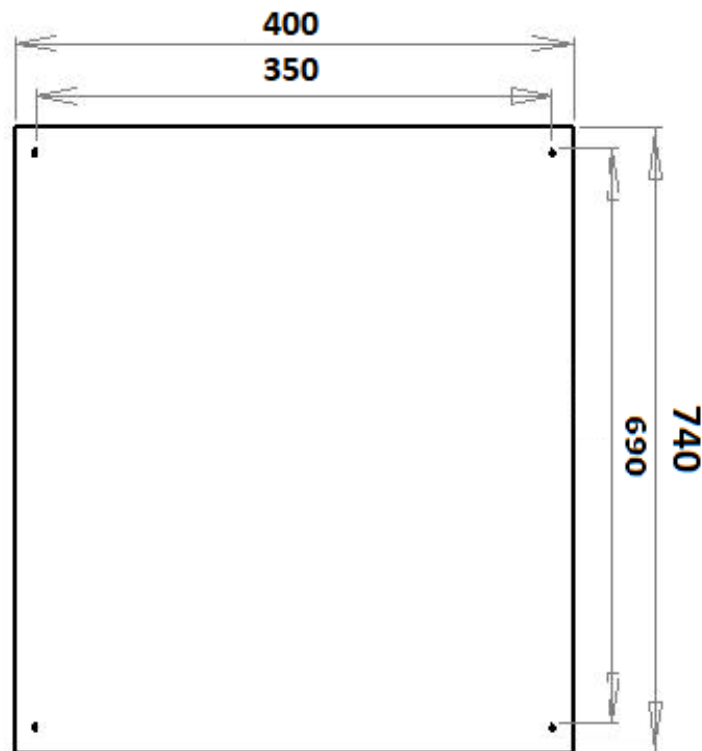

- ▶ Insert the 8mm dowels with the hammer.
- ▶ Position the panoply in front of previously drilled holes
- ▶ Insert the top screws first and tighten them
- ▶ Insert the lower screws and tighten them
- ▶ Use a spirit level to check for correct and accurate fixing to the wall

### 3) Mounting and connections

#### a) Installation and connection of the chlorine probe

- ▶ Unscrew the chlorine module mounting kit.
- ▶ Insert the chlorine probe into the lower seal, then into the lock nut, into the upper seal, finally the enhancement ring to the lock washer.
- ▶ Place the clamping nut provided with the probe along the probe body.
- ▶ Tighten chlorine probe nut for sealing

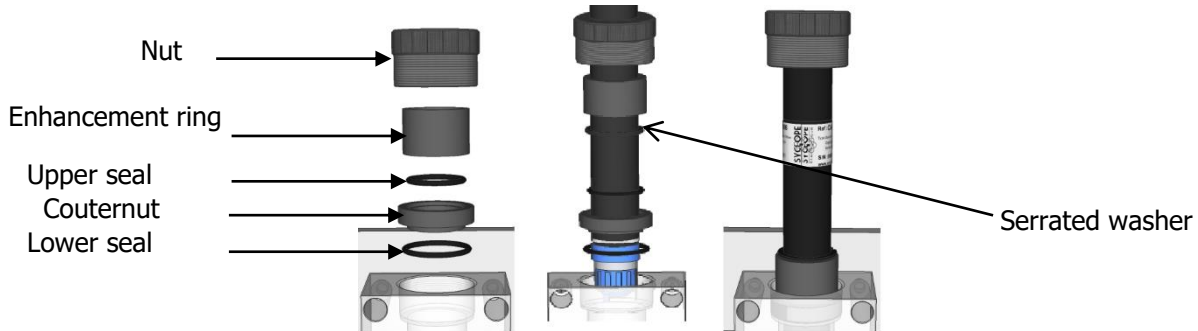

- ▶ Unscrew the top cap and the cable gland of the chlorine probe
- ▶ Insert the 2 points cable through the gland and then the top cap.
- ▶ Screw the **white** wire of the 2 pts cable to point **1** of the probe terminal block.
- ▶ Screw the **blue** wire of the 2 pts cable to point **2** of the probe terminal block
- ▶ Screw the top cap and cable gland together to seal the cable

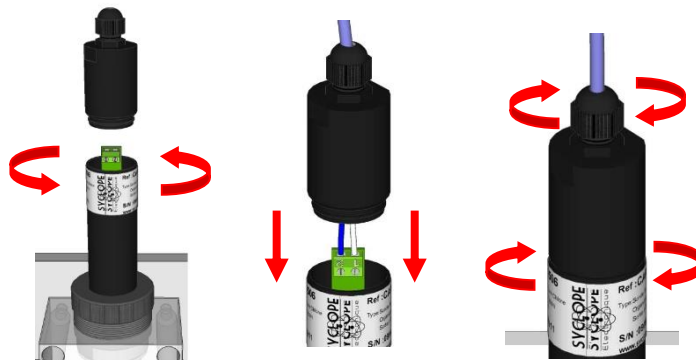

#### b) Installation and connection of the pH probe

- ▶ Remove the pH probe from its clear storage housing
- ▶ Insert the pH probe into the module
- ▶ Tighten the probe to seal
- ▶ Connect the pH probe cable to the pH probe connector

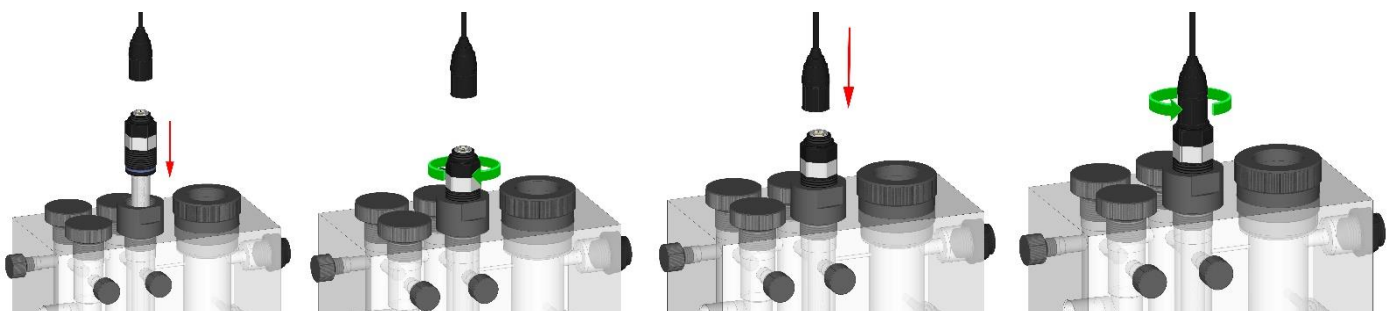

**V. Hydraulic connection of the SYCLOPE ODI TOUCH® panel**

1) Overview

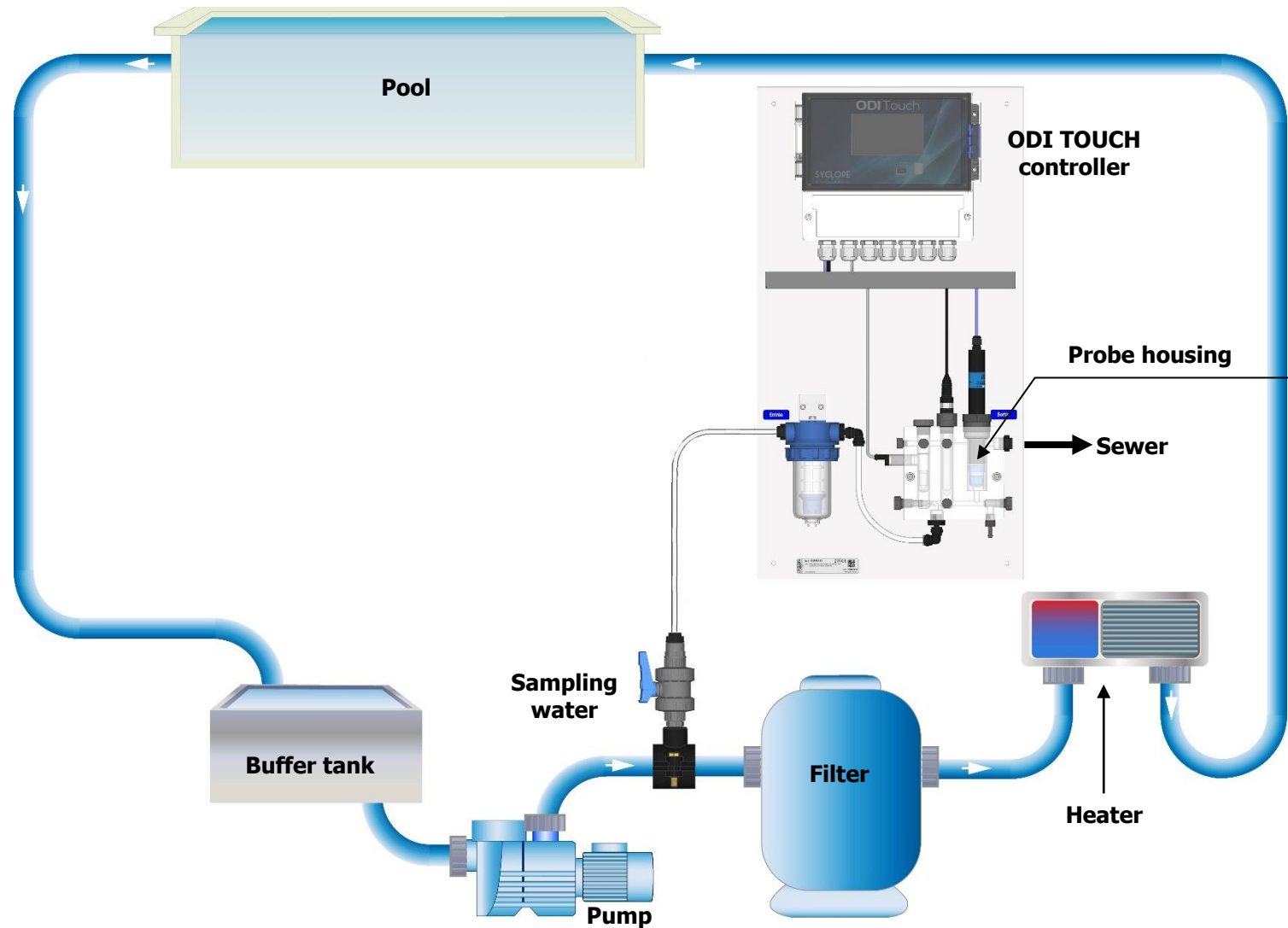

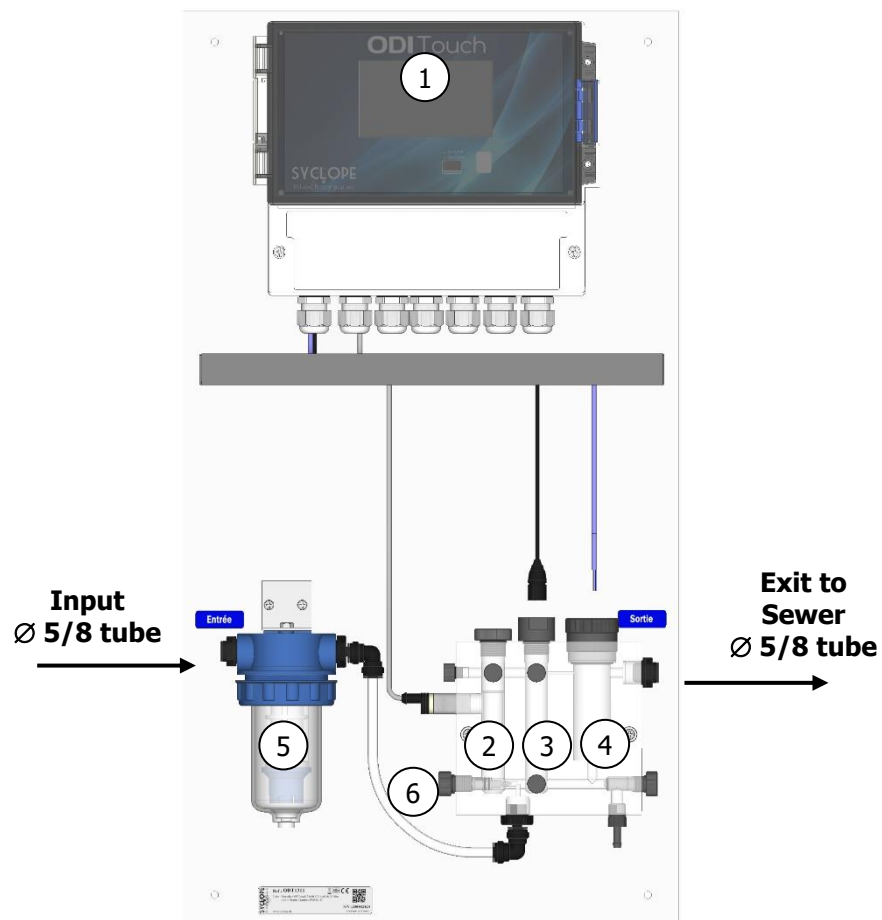
2) Hydraulic connections

- ① ODI TOUCH analyser/controller
- ② Flow detection module
- ③ pH measurement module
- ④ Chlorine measurement module
- ⑤ 60 µm sieve filter
- ⑥ Flow adjustment by manipulating the adjusting screw to the horizontal notch

## VI. Electrical connections of the SYCLOPE ODI TOUCH® panel

### 1) Power supply connections of the analyser

Electrical installations must be carried out according to the standards in force and by authorized personnel!



A 30mA differential circuit breaker must be installed upstream of the controller!

A 2A circuit breaker must be installed to protect the controller!

Before making the connections, switch off the power supplies!

The controller must be supplied with 230 VAC 50 Hz:

- ▶ Wire the Phase of the power supply on point 53 (L1) of terminal block X1 of the ODI TOUCH
- ▶ Wire the Neutral of the power supply to point 54 (N) of terminal block X1 of ODI TOUCH
- ▶ Wire the Ground from the power supply to point 55 (PE) of terminal block X1 of ODI TOUCH



### 2) Regulation outlet connections and programming

#### a) Relaying in an electrical cabinet:

The dosing devices are controlled by the relay outputs FO1 and FO2 "dry contact" (C.R.T). The relays, via 24 VDC signals, drive contactors that deliver power to the dosing devices.

- ▶ Pass the contactor control cables through a cable gland of the ODI TOUCH
- ▶ Connect one of the two control cables to terminal block FO1 between terminals 41 "T" and 42 "C"
- ▶ Connect the other control cable to terminal block FO2 between terminals 47 "T" and 48 "C"

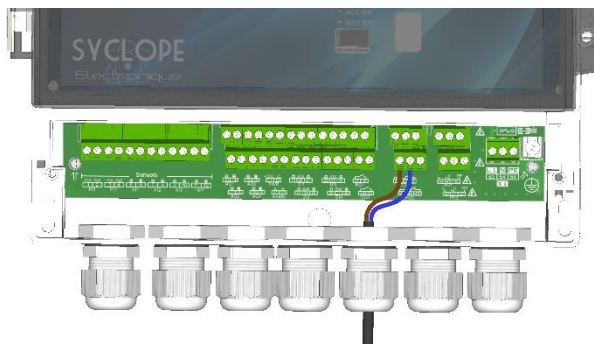

To stop the product dosing when there is no water circulation in the analysis chamber, the set has a flow detector connected to the control unit. This detector is connected to terminal block DI1, terminals 19 (+) and 21 (-) and terminal 20 (Signal).

b) Externally controlled pump control via kit ECK0002 (Recommended):

In order to guarantee an optimal service life of the relays, we recommend to control the pumps by dry contacts via external control cables. The pumps will be supplied continuously via 230VAC outlets. Two modes of regulations are possible:

*By "Pause" ON/OFF contact:*

- ▶ Connect one of the two external control cables to terminal block FO1 between terminals 43 "R" and 42 "C"
- ▶ Connect the other external control cables to terminal block FO2 between terminals 49 "R" and 48 "C"

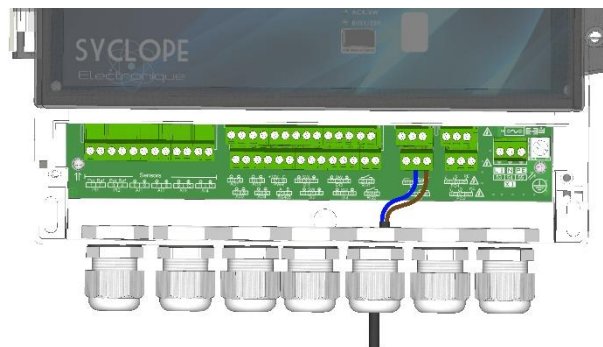

*By impulse contact:*

- ▶ Connect one of the two external control cables to terminal block RO1 between terminal 25 and 26
- ▶ Connect the other control cables to terminal block RO2 between terminals 39 and 40

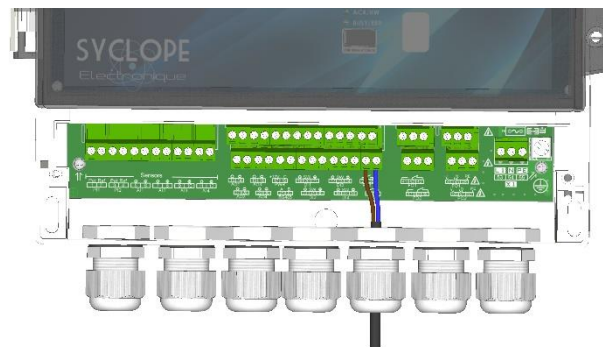

## c) Connecting external control cable to ECPxxxx pumps:

- ▶ Disassemble the pump cover using the Torx key provided in the ECK0002 kit.
- ▶ Mount the cable gland (provided in the kit) on the left side of the cover.
- ▶ Pass the external control cable and tighten the gland.



- ▶ Using a small blade screwdriver, connect the external control cable between the terminals:

- « GND » (1) and « Pause » (2) of the 3-point terminal block supplied in the ECK0002 kit for contact control "PAUSE ON/OFF"
- « GND » (1) and « Contact » (3) of the 3-point terminal block provided in the ECK0002 kit for "impulse" contact control.

- ▶ Connect the terminal block to the pump
- ▶ Close the pump cover with the Torx key

- ▶ If "PAUSE ON/OFF" contact control is preferred, set the pump pulse frequency potentiometer to the desired %

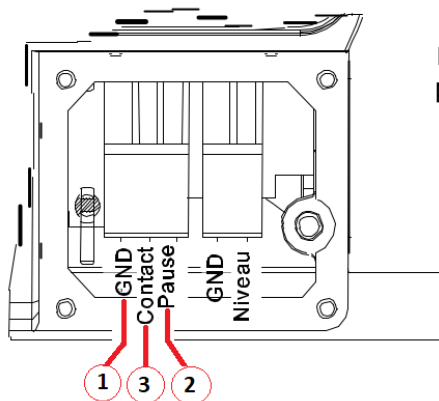

- ▶ ▶ If "IMPULSE" contact control is preferred, set the pump pulse frequency potentiometer to "EXTERN"



d) Programming of control mode:

Syclope ODITOUCH is factory configured for the use of the FO1 and FO2 dry contact relays in regulation.

The modification of the control outputs is done in the "INSTALLATION" menu by pressing the "MENU" key

key , on the "INSTALLATION MENU" tab, then on the "OUTPUTS" tab:

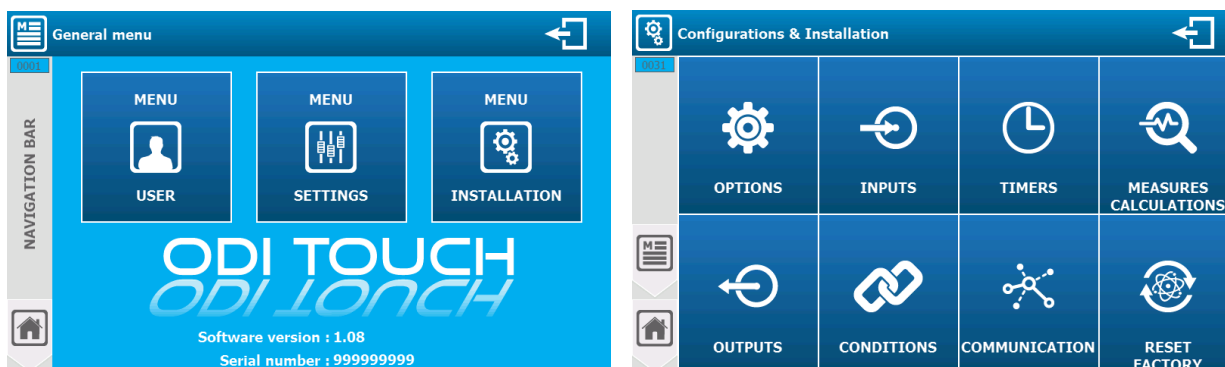

*"PAUSE ON/OFF" contact control:*

From the factory, the FO1 and FO2 dry contact relays are programmed for regulation ("Dosing") :

- FO1 is assigned to the pH pathway in down control
- FO2 is assigned to the free chlorine pathway in ascending regulation

From the factory, the two controls are configured in PWM (Cycle Width) for proportional regulation by cycle time (ON/OFF).

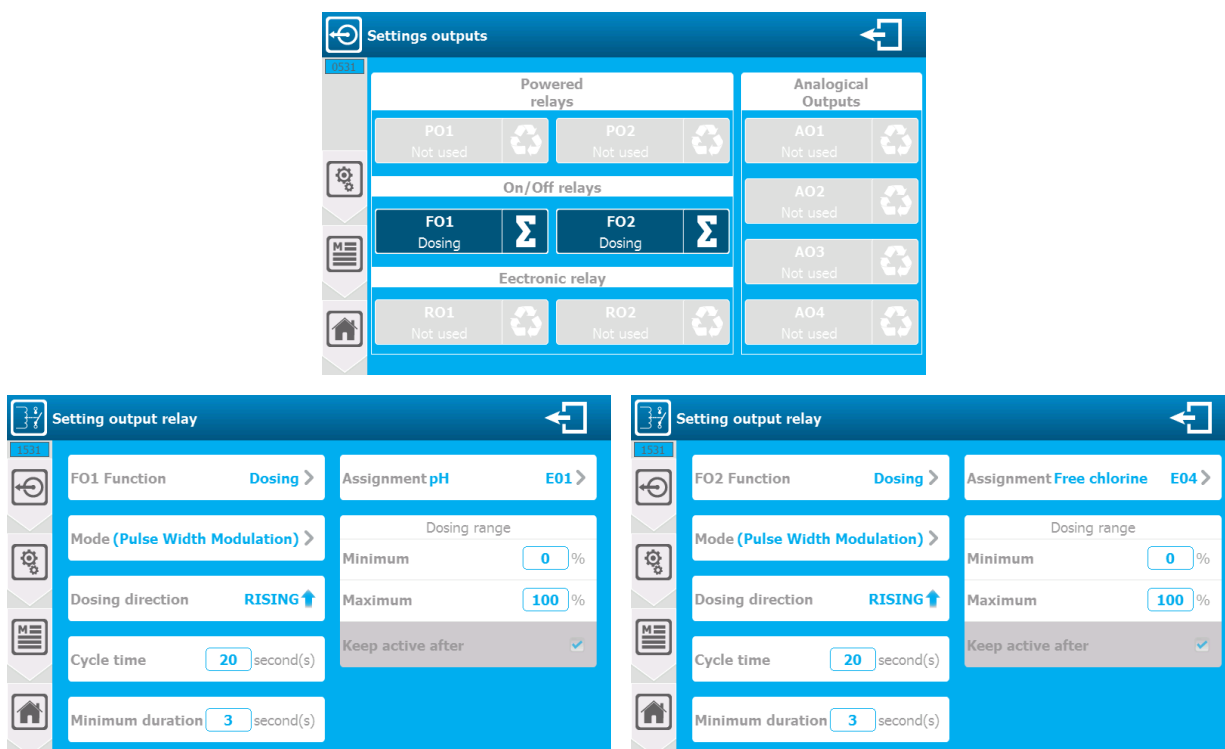

Factory settings can be used for contact control "PAUSE ON/OFF".

**However, cycle times will need to be adapted to the basins.**



*"IMPULSE" contact regulation:*

Impulse control is carried out via the electronic relays RO1 and RO2. To perform the function, it's necessary to deprogram the relays FO1 and FO2 and then program the relays RO1 and RO2 indicating:

*The function:* Dosing

*Allocation:* pH or Free Chlorine measurement pathway

*Regulation mode:* PFM (Impulse)

*Direction of dosage:* RISING or FALLING

*The PFM frequency:* Number of pulses per minute MAX when the dosing need is 100%.

**The MAX pulse frequency should be adapted according to the basins.**

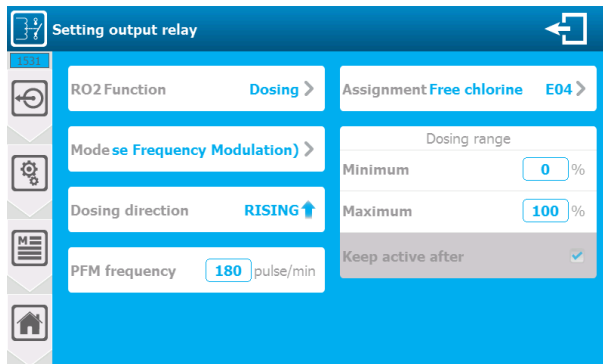
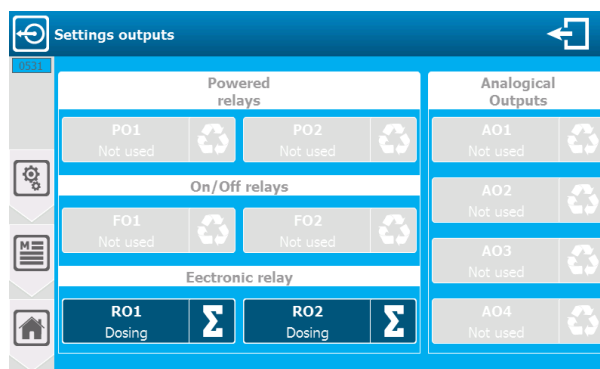

**VII. Maintenance of the SYCLOPE ODI TOUCH panel**1) Replacement of the free and total chlorine probe membrane

- ▶ Completely close the isolation valve on the filter
- ▶ Remove the chlorine probe out of the housing
- ▶ Unscrew the membrane cap. This membrane cap shouldn't be reused
- ▶ Rinse the bottom of the probe with potable water (water without chlorine) by delicately removing excess of electrolyte with the finger.
- ▶ Remove the remaining water on the probe with a paper towel without scratching the electrodes. Measuring electrodes can be destroyed if this operation isn't done correctly.

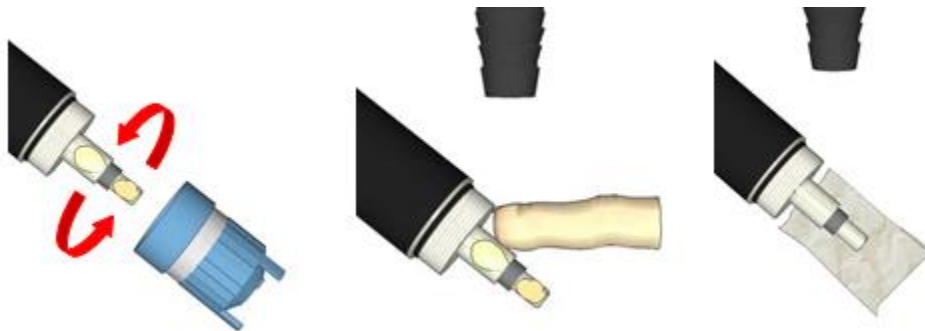

- ▶ Completely close the isolation valve on the filter
- ▶ Remove the chlorine probe out of the housing
- ▶ Unscrew the membrane cap. This membrane cap shouldn't be reused
- ▶ Rinse the bottom of the probe with potable water (water without chlorine) by delicately removing excess of electrolyte with the finger.
- ▶ Remove the remaining water on the probe with a paper towel without scratching the electrodes. Measuring electrodes can be destroyed if this operation isn't done correctly.

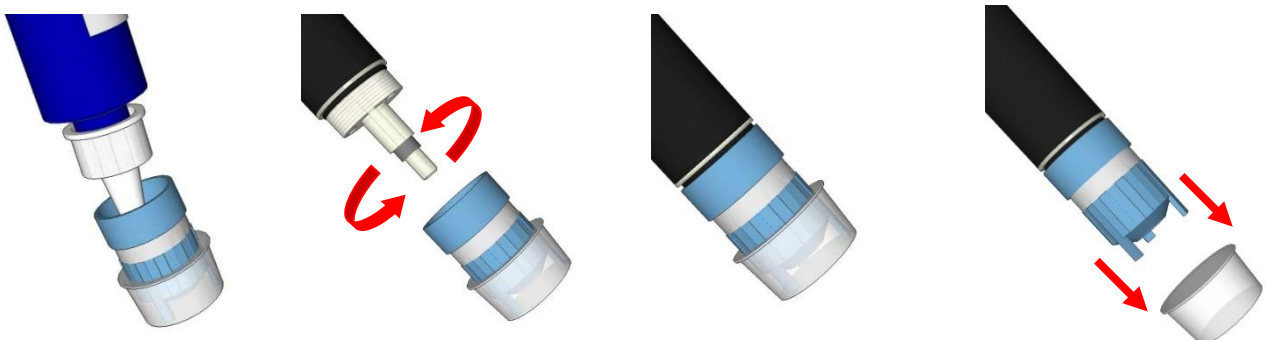

## 2) Cleaning the filter

- ▶ Completely close the isolation valve on the filter
- ▶ Unscrew the clear filter head
- ▶ Remove the sieve from its location
- ▶ Extract the top and bottom of the sieve being careful not to lose the seals
- ▶ Clean the sieve under clear water
- ▶ Put back the upper and lower parts of the sieve
- ▶ Put the sieve back into its place in the filter

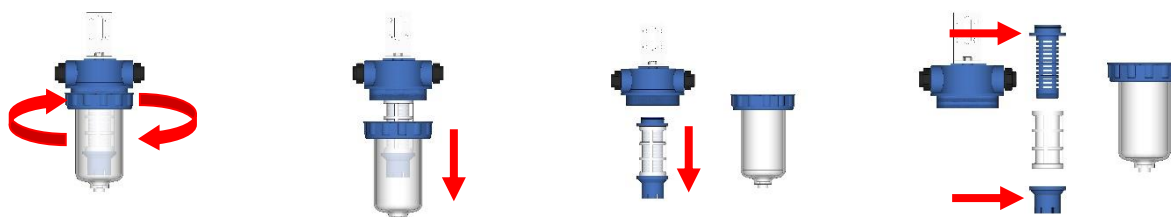

- ▶ Screw the clear filter head firmly onto its base to seal
- ▶ Open the isolation valve according to your needs

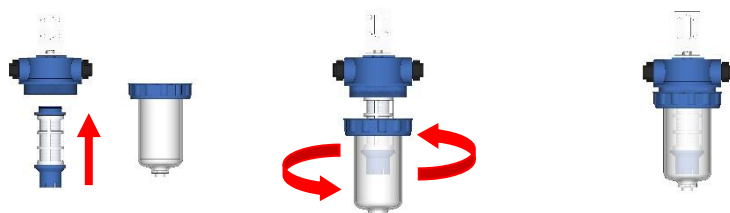

## 3) Wintering of the panel

This procedure is applicable for a technical shutdown, for wintering or for a prolonged shutdown of the analysis system.

- ▶ Power off the analyser using the main circuit breaker
- ▶ Completely close the isolation valve located on the sampling point
- ▶ Rinse dosing pumps by pumping clear water

### a) Wintering of the pH probe

- ▶ Remove the pH sensor out of the probe housing
- ▶ Fill the pH probe storage tube with KCL (See accessories)
- ▶ Insert the pH probe into the storage tube
- ▶ Screw it in to seal
- ▶ Replace the cap on the pH probe connector to prevent oxidation
- ▶ Put the probe in its original packaging and store it in a dry place

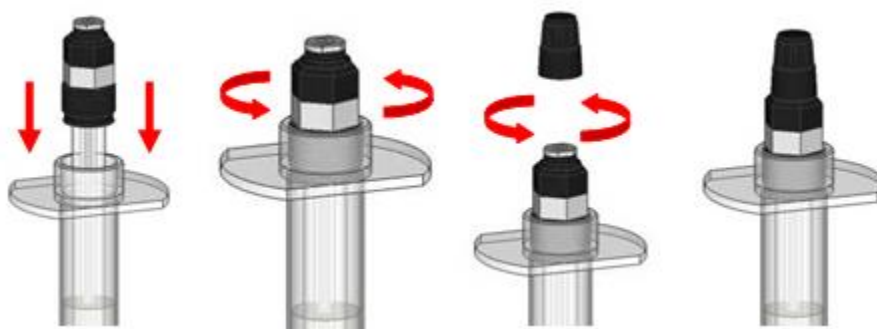

## b) Wintering of the chlorine probe

- ▶ Remove the Chlorine probe out of the probe housing
- ▶ Unscrew the membrane cap. This membrane cap shouldn't be reused.
- ▶ Rinse the bottom of the probe with potable water (water without chlorine) by delicately removing excess of electrolyte with the finger.
- ▶ Remove the remaining water on the probe with a paper towel without scratching the electrodes. Measuring electrodes can be destroyed if this operation isn't done correctly.

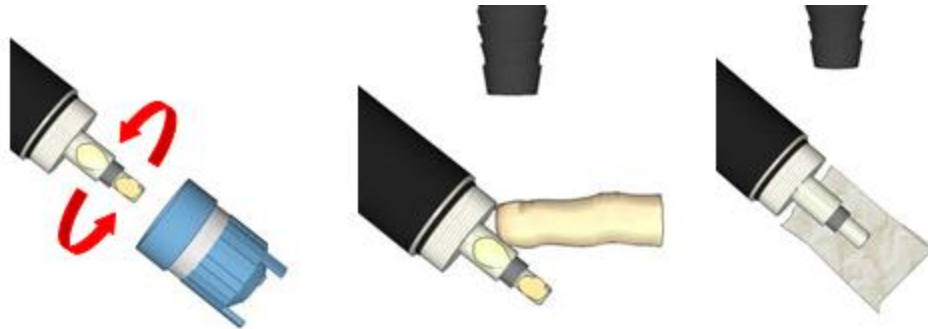

- ▶ Put the dried probe in its original packaging and keep it in a dry place

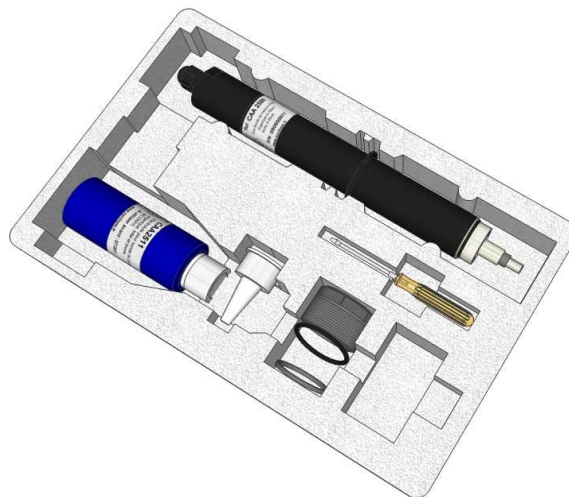

**VIII. General characteristics of SYCLOPE ODI TOUCH® panel**

<b>General characteristics</b>	
<b>Type</b>	<b>Specification(s)</b>
Permissible ambient temperature	5°C to 45°C (41°F to 113°F)
Permissible fluid temperature	1 to 45°C (34°F to 122°F)
Humidity	90% maximum without condensation
Material of the plate	Expanded PVC
Material of the probe housing	PMMA / PVC / EPDM / PE
Material of the delivered tube	PE
Material of the inlet valve	PVC
Hydraulic connection	Input: 5/8 tube Quick coupling Outlet: 5/8 tube Splined fitting
Permissible pressure	0,5 bar max.
Power supply	230 VAC 50 Hz
Size of the parcel on delivery	Length: 42 cm Width: 76 cm Heigh: 22 cm

## IX. Spare parts and consumables of the SYCLOPE ODI TOUCH® panel

### 1) Spare parts and consumables

Reference	Designation
ODT0000	ODI TOUCH Controller
BMT4011	Modular probe housing 4T PMMA/PVC 1x1"1/4 + 1xPG13,5 Acetal 8x5 Quick
CAA2306	Free chlorine sensor 0-10ppm (Gold) 4...20mA
CAA2503	Total chlorine sensor 0-10ppm
PFM0007	6"1/2 pre-filter with 60 µm Nylon sleeve, tube connections 5x8 mm
PEN0008	60 µm washable nylon sleeve for filter PFM0006_7
PEF1006	Flow-switch PNP for PMMA probe housing (MODUPAC, INDIGO, UNISEAU, ODI, TRACEO)
SOL0001	KCL solution 3 mol 250ml
FTH2503	Storage sleeve for pH/Redox probe

### 2) Consumables

Reference	Designation
CAA2509	Membrane for free chlorine, total chlorine or bromine sensors
CAA2511	Electrolyte for free chlorine, total chlorine or bromine sensors
CAA2549	Maintenance kit for chlorine probe (1 electrolyte + 2 membranes)
TPE0805	5x8mm pressure PE tube

## **X. Warranty**

SYCLOPE Electronique S.A.S. guarantees the purchaser of this unit that it will be free from defects in workmanship for the use specified in this manual for a period of 1 year from the date of delivery to the original purchaser.

The warranty is limited to the replacement of defective parts in the factory. Normal wear parts and consumables necessary for the maintenance of the device are excluded from the warranty.

The original purchaser is responsible for the return to the factory of the device and its accessories at its expense.

SYCLOPE Electronique SAS is not responsible for damage to the device or parts of the device resulting from misuse, environmental corrosion, negligence or accidents, defects resulting from repairs, changes or installation made by an unauthorized person not trained by SYCLOPE Electronique SAS. SYCLOPE Electronics assumes no liability for damage caused by misuse, improper programming of the device or use of the device by inexperienced or untrained personnel or improper installation.

In the event of damage during the transport, the principal buyer must imperatively declare it to the carrier and make to note its nature. SYCLOPE Electronique S.A.S cannot be held responsible for damage caused during shipping.













**SYCLOPE Electronique S.A.S.**

Z.I. Aéroport Pyrénées  
Rue du Bruscos  
64 230 SAUVAGNON - France –  
Tel: (33) 05 59 33 70 36  
Fax: (33) 05 59 33 70 37  
Email: [syclope@syclope.fr](mailto:syclope@syclope.fr)  
Internet: <http://www.syclope.fr>

© 2020 by SYCLOPE Electronique S.A.S.