

## **SYCLOPE TERE'O Touch® controller for swimming pools (Part 1)**



### **Installation, commissioning and operating instructions**



Parts of the general documentation

- ▶ Part 1 : Manual of installation, commissioning and operating instructions
- Part 2 : Manual of communication instructions

---

**General informations :**

**SYCLOPE Electronique 2018 2019<sup>®</sup>** Notice of 25/02/2019 Rev 1.1

Analysers/controller for private and public swimming pools.

**TERE'O Touch<sup>®</sup> product line**

Installation, commissioning and operating instructions

Editor :



**SYCLOPE Electronique S.A.S.**

Z.I. Aéropole pyrénées

Rue du Bruscos

64 230 SAUVAGNON - France –

Tel : (33) 05 59 33 70 36

Fax : (33) 05 59 33 70 37

Email : [syclope@syclope.fr](mailto:syclope@syclope.fr)

Internet : <http://www.syclope.fr>

© 2018 by SYCLOPE Electronique S.A.S.

Subject to modifications

# Summary

I.	General .....	4
1)	Field application .....	4
2)	FCC conformity .....	5
3)	Use of this document.....	6
4)	Signs and safety symbols.....	6
5)	Storage and transport.....	7
6)	Packaging .....	7
7)	Warranty .....	7
II.	Environment and safety instructions .....	8
1)	Use of the equipment .....	8
2)	User obligations .....	8
3)	Risk prevention .....	8
4)	Identification and localization of the identification plate .....	9
5)	Disposal and conformity.....	10
III.	Technical characteristics and functions .....	11
1)	Technical characteristics .....	11
2)	Main functions.....	12
3)	Parameter and scale of measurements .....	12
IV.	Installation and wiring .....	13
1)	Installation conditions.....	13
2)	Installation of the wall-mounted controllers.....	13
3)	Opening/Closing the transparent door .....	14
4)	Opening/Closing connection cover .....	14
	Use a specific screwdriver to remove the two screws for opening the cover .....	14
5)	Electrical connections .....	15
6)	Changing internal fuses of P3 and P4 outputs .....	15
7)	Connecting primary power supply.....	16
8)	Connecting the self-powered control dosing relay.....	17
9)	Connecting the potential-free relay (P2).....	18
10)	Connecting measurement inputs.....	19
11)	Connecting digital inputs .....	21
12)	Connecting tank level switch .....	22
13)	Connecting the RS485 communication por .....	23
V.	General use .....	25
VI.	Commissioning.....	26
VII.	Programming the controller.....	26
1)	Principal display .....	26
2)	Input mode.....	29
3)	Programming Menu « Installer » .....	31
VIII.	Parameter setting.....	43
1)	Tank level.....	44
2)	Control .....	45
3)	Dosing.....	46
4)	Timings .....	47
5)	Calibration .....	47
IX.	Maintenance .....	49

## I. General

### 1) Field application

The analyser/controller of the **SYCLOPE TERE'O Touch**<sup>®</sup> range you have just purchased is an electronic swimming-pool water management device. It has been carefully developed and manufactured to ensure your greatest pleasure and peace of mind.

Its remarkable capacity for adapting to different conditions and sizes of private or public swimming pools means it can be installed in the most difficult of environments where control of water treatment and swimming-pool water regulation processes are decisive.

The **SYCLOPE TERE'O Touch**<sup>®</sup> range are equipped with one temperature entry and two specific electronic card adaptors for pH, ORP or chlorine/bromine for measurements using specific sensors for treating swimming-pool water and also include regulations processes with cyclic commands transmitted by means of two relays to control pH and chlorine levels.

The simplicity of operation of the **SYCLOPE TERE'O Touch**<sup>®</sup>, the user friendliness and the remarkable technical aspects of these devices, will ensure you benefit from their many options, guaranteeing you full control and supervision of the quality of the water in your swimming pool.

The following instructions contain all the information required for the installation, use and maintenance of your new equipment.

- Packaging
- Installation
- Technical specifications
- Commissioning instructions
- Safety tips

If you would like to receive further information or if you encounter any difficulties not described in this manual, please contact your usual retailer or else directly contact the sales department of SYCLOPE Electronique in France, either at the agency or at the office for your region or country, or the technical/quality departments of our establishments. We will do everything in our power to help you and ensure you benefit from our advice and know-how in the field of measurement and treatment of swimming-pool water.

Contact : [Service-technique@syclope.fr](mailto:Service-technique@syclope.fr)

## 2) FCC conformity

The **SYCLOPE TERE'O Touch**<sup>®</sup> controller complies with Part 15 of the FCC Rules. Operation is subject to the following two conditions:

(1) this device may not cause harmful interference (2) this device must accept any interference received, including interference that may cause undesired operation  
FCC Regulations state that unauthorized changes or modifications to this equipment may void the user's authority to operate it.

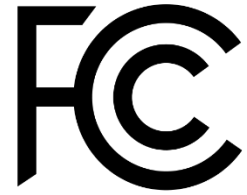

This equipment has been tested and found to comply with the limits for a Class B digital device, pursuant to Part 15 of the FCC Rules. These limits are designed to provide reasonable protection against harmful interference in a residential installation. This equipment generates, uses, and can radiate radio frequency energy and, if not installed and used in accordance with the instructions, may cause harmful interference to radio communications. However there is no guarantee that interference will not occur in a particular installation.

If this equipment does cause harmful interference to radio or television reception, which can be determined by turning the equipment off and on, the user is encouraged to try and correct the interference by one or more of the following measures:

- Reorient or relocate the receiving antenna.
- Increase the separation between the equipment and receiver.
- Connect this equipment into an outlet on a circuit different from that to which the receiver is connected.
- Consult the dealer or an experienced radio/TV technician for help.

Changes and modifications not expressly approved by the manufacturer could void the user's authority to operate this equipment.

**Remark :** To ensure compliance with the FCC regulations on electromagnetic interference for a class B device, use cables properly shielded and connected to the ground as recommended in this manual. The use of a cable that is not properly shielded or earthed for risk of violating the FCC rules.

### 3) Use of this document

Please read this entire document before starting to install, adjust or commission your device, in order to ensure the safety of swimmers, users and equipment.

The information provided in this document must be strictly observed. **SYCLOPE Electronique S.A.S.** declines all responsibility in cases where failure to comply with the instructions of this documents is observed.

The following symbols and pictograms will be used to facilitate reading and understanding of these instructions.

- Information
- ▶ Action to be taken
- Item of a list or catalogue

### 4) Signs and safety symbols



Identify a continuous voltage or a continuous current



Identify an alternative voltage or an alternative current



Protective ground



Functional ground



Risk of injury or accident. Identify a warning concerning a potentially dangerous risk. Documentation must be consulted by the user with each time the symbol is notified. If the instructions are not respected, that presents a risk of death, physical injuries or property damages.



Electric hazard. Identify a warning statement relative to a mortal electric danger. If the instructions are not strictly respected, that implies an inevitable risk of physical injuries or death.



Risk of incorrect operation or damage for the device.



Comment or particular information.



Recyclable element

### 5) Storage and transport



It is important to store and transport your **SYCLOPE TERE'O Touch**<sup>®</sup> in its original packaging in order to minimize risk of damage.

Furthermore, the package must be stored in an environment that is protected against humidity and exposure to chemical products.

Environmental conditions for transport and storage:

Temperature : -10 °C to 70 °C

Air humidity: Maximum of 90% with no condensation

### 6) Packaging



The controller is delivered without electrical power cable.

The pre-holes of the box are drilled and equipped with according electrical glands in compliance with IP65 level protection. Cables must be adapted to the electrical glands to respect the level of protection.

Grounded cables for connecting pH and ORP (Redox) sensors are not provided.

Content of the packaging :

- ✓ One analyzer/controller **SYCLOPE TERE'O Touch**<sup>®</sup>
- ✓ Installation and starting instruction notice
- ✓ Programming notice
- ✓ Communication notice (Option)

### 7) Warranty

The warranty is provided according to the terms of our general conditions of sale and delivery as long as the following conditions are met:

- Use of the equipment according to the instructions of this notice
- No modifications of the equipment which may modify its behavior and no incorrect manipulation
- Respect for the electrical safety conditions



Consumable material is no longer covered by the warranty when in use.

## II. Environment and safety instructions

Please :

- Read this manual carefully before unpacking, installing or commissioning this equipment
- Take into account all the hazards and recommended precautionary measures

Failure to respect these procedures can result in serious injury to users or damage the device.

### 1) Use of the equipment

The **SYCLOPE TERE'O Touch**<sup>®</sup> system has been designed to measure and regulate pH, Redox (ORP), chlorine (or bromine) by means of sensors and controls of suitable actuators in the context of the possible uses described in this manual.



All other uses are considered to be non-conforming and must therefore be forbidden. SYCLOPE Electronique S.A.S. will not be responsible in any case for any damages that result from such uses.



Any use of sensors or interfaces not-in conformity to the features defined in this handbook must also be proscribed.

### 2) User obligations

The user undertakes not to allow its employees to work with the **SYCLOPE TERE'O Touch**<sup>®</sup> equipment described in this manual unless they:

- Are aware of the fundamental instructions relating to work safety and prevention of accidents
- Are trained in the use of the device and its environment
- Have read and understood these instructions, warnings and manipulation rules

### 3) Risk prevention



The installation and connection of the **SYCLOPE TERE'O Touch**<sup>®</sup> equipment should only be performed by personnel specialized and qualified for this task.  
The installation must comply with current safety standards and instructions!



Before switching the controller on or manipulating the relay outputs, remember always to cut off the primary power supply!  
Never open the controller when it is powered on!  
Maintenance operations and repairs should only be performed by trained, specialized personnel!



Take care when choosing the location for installing the equipment according to the environment!  
The **SYCLOPE TERE'O Touch**<sup>®</sup> electronic box should not be installed in a hazardous environment and should be protected against splashing with water or chemical products. It should be installed in a dry, well-ventilated location, isolated from corrosive vapours.





Make sure that the chemical sensors used with this device correspond well to the chemicals used. Refer to the individual technical note of each sensor. Chemistry of water is very complex, in case of doubt, contact immediately our engineering service or your approved installer/reseller.



Chemical sensors are sensitive elements using consumable parts. They must be supervised, maintained and calibrated regularly using specific calibrator systems not-provided with this equipment. In the event of defect, a surplus possible hazard of chemical injections can be noted. In the doubt, a service contract must be taken near your reseller/installer or failing this near our engineering services. Contact your approved installer/reseller or our business service for more information.

4) Identification and localization of the identification plate

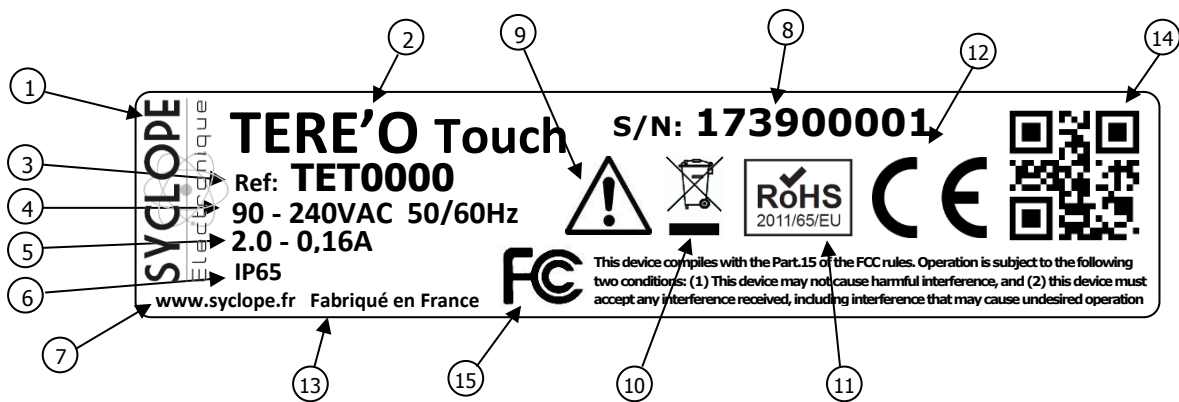

① Label of the manufacturer	⑨ Particular risks. Read the notice
② Model of the product	⑩ Product which can be recycled
③ Reference of the product	⑪ Limitation of dangerous substances
④ Range of power supply	⑫ EC compliance
⑤ Values of the maximum current	⑬ Country of the manufacturer
⑥ Class of protection	⑭ Manufacturer square code
⑦ Identification of the manufacturer	⑮ Conformity with the FCC part 15 Class B
⑧ Serial number	

Identification plate

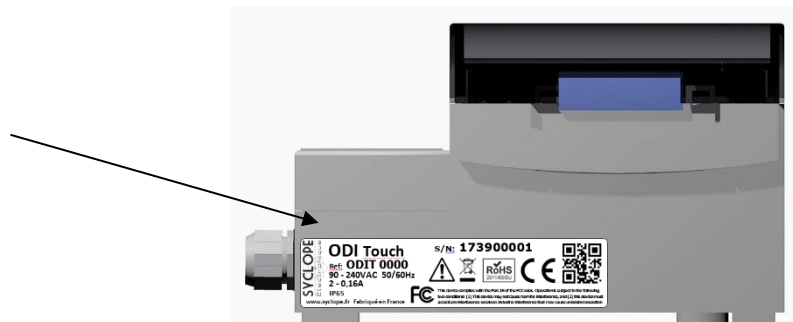

### 5) Disposal and conformity

The recyclable packaging of the **SYCLOPE TERE'O Touch**<sup>®</sup> equipment must be disposed of according to current regulations.



Elements such as paper, cardboard, plastic or any other recyclable elements must be taken to a suitable sorting center.



According to European directive 2002/96/EC, this symbol means that as of 12 August 2005 electrical appliances cannot be thrown out together with household or industrial waste. According to current regulations, consumers within the European Union are required, as of this date, to return their used devices to the manufacturer, who will take care of disposing them at no extra expense.



According to European directive 2002/95/EC, this symbol means that the **SYCLOPE TERE'O Touch**<sup>®</sup> controller is designed in compliance with the restrictions on hazardous substances



According to low-voltage directive (2006/95/EC) and the electromagnetic compatibility directive (2004/108/EC), this symbol means that the device has been designed in compliance with the previously cited directives.



In accordance with part 15 of the FCC regulation (Federal communications commission), this symbol indicates that the device was tested and approved under the respect and the conditions of the limits for a Class B digital device.

**III. Technical characteristics and functions**1) Technical characteristics

<b>General characteristics</b>		
Type	Specification(s)	Marker(s)
Consumption	0,3 to 0,16A maximum (without external loads)	-
Power supply required	Between 90V and 240V 50/60Hz	-
Electric protection	Electronic fuse 160mA. Auto-rearmed when power off	F4
Operating temperature (°C)	-5 °C to 45 °C (23 °F to 113 °F)	-
Storage temperature (°C)	-10 °C to 70 °C (10 °F to 158 °F)	-
Humidity	Max. 90% without condensation	-
Case material	ABS or Polycarbonate (US and Canada)	-
Case dimensions	Length : 213 mm (8.4 inches) Width : 185 mm (7.3 inches) Height : 118 mm (4.6 inches)	-
Weight of the case	1,1 kg	-
Protection rating	IP 65	-
Display	3.5 Inch Resistive LCD Touch Screen	-
<b>Inputs</b>		
Measurement inputs	1 pH isolated module Range : -400mV to +400mV 1 4...20mA isolated powered 24VDC (Temperature) 1 4...20mA isolated powered 24VDC (chlorine/Bromine)	POT IN1 IN2
Level inputs	1 pH tank level input 1 Chlorine/Bromine tank level input	K1 K2
Flow input	1 Flow input	Aux
<b>Outputs</b>		
Relay outputs	2x Powered relay outputs - Max. 2A / 250 VAC - Inrush current Max. 15A <1ms 1 CRT relay	P3 et P4 P2
REF	24VDC power output for supplying converters or external flow switch sensors.	VREF
<b>Communication port</b>		
RS485	1 RS485 communication port compatible with ModBus © RTU protocol.	
<b>Protection of powered outputs</b>		
Internal fuse	Glass fuse 5x20mm 2A 250V timed	FUSE1

2) Main functions

<b>Main functions</b>		
Function	Specification(s)	Marker(s)
Mode of control	Proportional	Control from 0 to 100% Cycle time : 240s
	On / Off	
Actuator type	Powered relays 90...240VAC 5A	PWM command
Direction	Up or Down	
Alarms	Low and high alarms	Expressed in real measurement values. Threshold controls up and down.
Closed-loop control	Flow switch control	Closed-loop control of injections with control of water circulation.
	Tank level	Closed-loop control of injections with control of tank level.
Configuration	Std configuration	Automatic selection of parameters
Maintenance	Maintenance program	Internal test program procedures

3) Parameter and scale of measurements

<b>Measures and controls</b>		
Parameters	Scale of measurement	Precision
T°C	-5 to 45°C	± 0,5 %
pH	0 to 14 pH	± 0,5 %
Free chlorine	0 to 2 ppm	± 0,5 %
	0 to 10 ppm	± 0,5 %
Bromine	0 to 2 ppm	± 0,5 %
	0 to 10 ppm	± 0,5 %

#### IV. Installation and wiring

##### 1) Installation conditions



To guarantee user safety and ensure correct operation of your **SYCLOPE TERE'O®**, please observe the following installation instructions:

- Install the controller in a dry location
- The controller must be protected against rain, frost and direct sunlight
- The room temperature must range between 0°C and 50°C, with no condensation.
- Choose an installation location free from vibration, on a suitable support and with no deformation



If these instructions are not observed:

- The controller is at risk of being damaged
- The measurements can be disrupted
- The warranty is not applicable!

##### 2) Installation of the wall-mounted controllers



Before performing the installation and electrical connections, remember to turn off the power! The rating of IP65 is only guaranteed when the closing cover and the glass of the electric box are closed and when the cable glands match the diameters of your cables and are correctly sealed

- ▶ Drilling three holes ( $\varnothing$  5-mm) according to the following drilling plan:

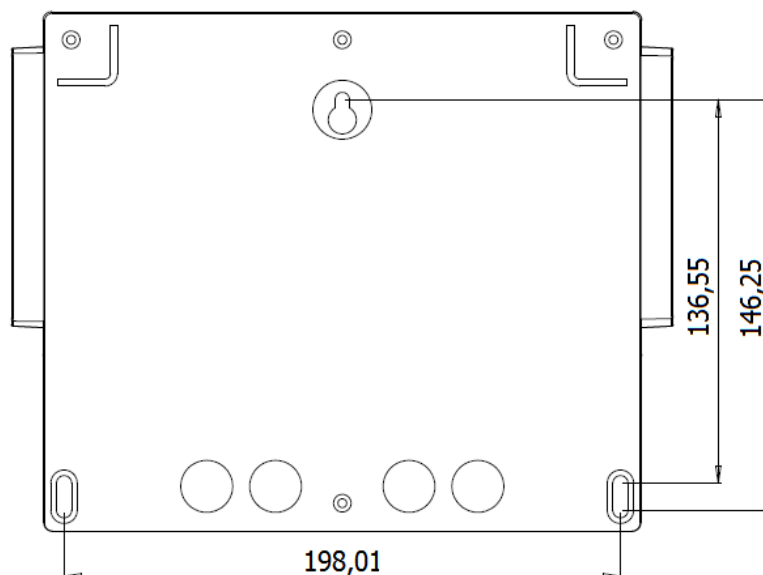

- ▶ Insert the 5-mm plugs using a hammer
- ▶ Insert the upper screw (top screw) first without completely tightening it
- ▶ Insert the lower screws and tighten them
- ▶ Tighten the upper screw
- ▶ Use a spirit level to check for correct and accurate fixing to the wall.

### 3) Opening/Closing the transparent door



To ensure IP65 protection class, the transparent door must be closed after usage and being sure of the O-ring quality each time.

The controller box is equipped with an automatic lock system which must be understood to manipulate it.

For opening the transparent door:

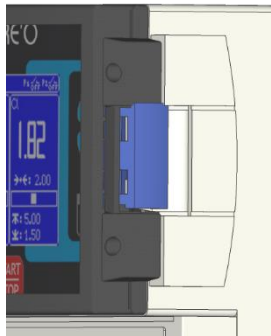

Locked ...

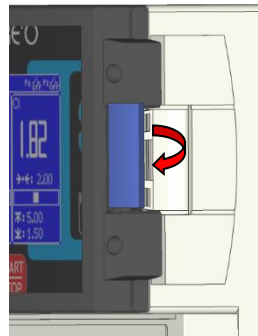

Raise the lock and pull forward it.

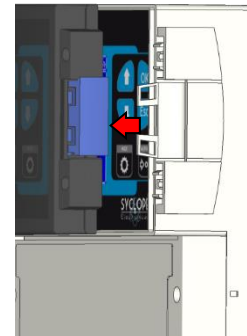

Opened!

For opening and locking transparent door:

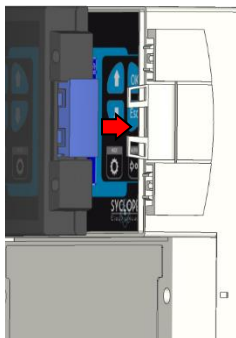

Pass the fingers behind the lock and bring the door with the inch ...

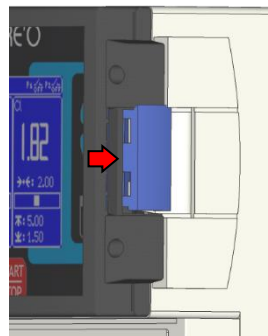

With the palm of the hand, press on the transparent door and tighten with the hand to lock.

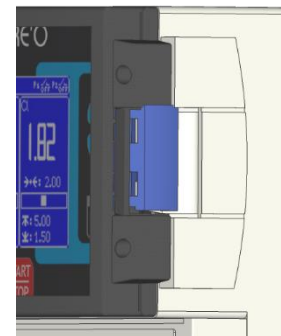

Locked!

### 4) Opening/Closing connection cover



To ensure IP65 protection class, the connection cover must be closed after usage and the O-ring must be checked each time.

Use a specific screwdriver to remove the two screws for opening the cover.

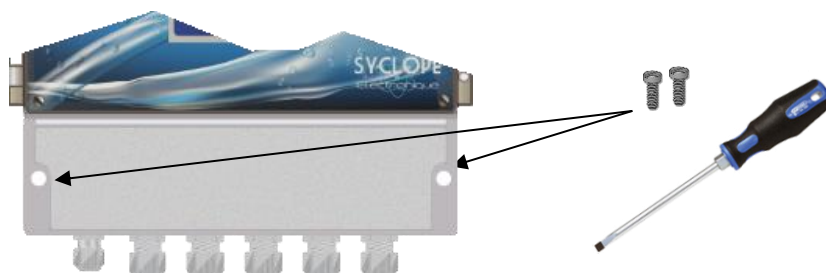

5) Electrical connections

The electrical installation must be performed in accordance with current standards by authorized personnel!

A 30mA differential circuit breaker must be installed!

A breaker circuit of maximum 10A must be installed near the controller and easily accessible to stop the main power. It must be identified as a circuit-breaker for the controller!

**Before performing the connections, remember to turn off the power!**



Use multicore cables if possible!

If not possible, always use a special wiring tip to be sure that wires do not make a contact together!

Protect the wirings by using electrical clamps.



The **SYCLOPE TERE'O Touch**<sup>®</sup> controller must be connected to the main circulation pump system by means of "FLW" entry and with the flow-switch of the measuring chamber.

**Internal protection :**

The controller is protected by an internal resettable fuse of 160mA and by a varistor of 275VAC for surge protection.



The self-powered relays **P3** and **P4** are protected each by a glass 5x20 fuse of 5A 250V.

Reference	Name
FUS5X20R2000	Time Delay Fuse 2A 5x20 Glass



In case of fuse destroyed, check that the card is not burnt out. If this is the case, the complete card must be changed!

In case of varistor burned, please return the controller to our technical after-sales department for repairing!

6) Changing internal fuses of P3 and P4 outputs

Before changing any fuse, disconnect the power supply!



Use only an original fuse. Don't replace it by another one with a higher current!

Open the translucent door and remove the 4 screws with an adequate screwdriver.  
Disconnect the flat cable between the electronic cards carefully.



Localize the fuse to be change on the bottom card ...  
 Remove the protection cover on the support of fuse ...  
 Change the fuse and reinstall the protection cover.

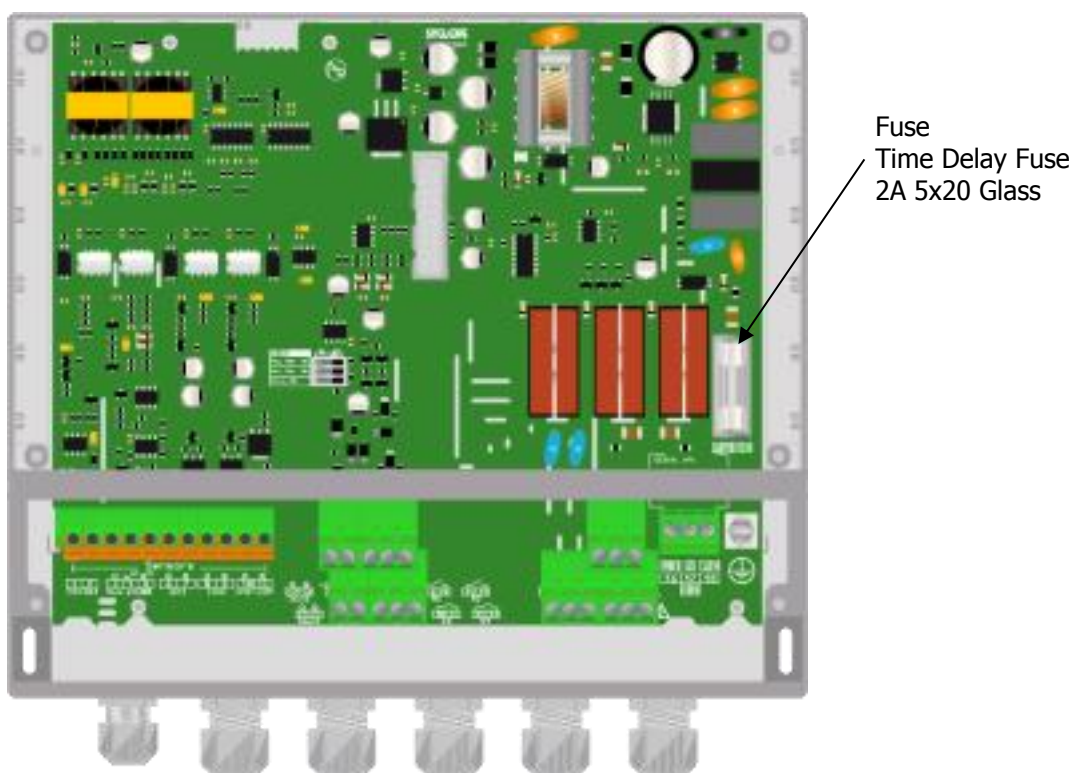

Reconnect the flat cable between the electronic cards and put the 4 screws to fix the front face. Don't screw them hardly because the electronic box is made in plastic material.

7) Connecting primary power supply



The **SYCLOPE TERE'O Touch**® controller is equipped with a switching power supply. It is therefore able to be supplied by AC voltage comprised between 90V to 240V - 50/60Hz.





- ▶ Use a 3-point 1.5 mm<sup>2</sup> cable to wire the power supply
- ▶ Strip the 3 wires for 7mm
- ▶ Pass the 3-point cable through a cable gland
- ▶ Wire the live cable to **L1** and the neutral to **N** located "**X1**"
- ▶ Wire the ground to the ground plot PL1 with an insulated round terminal
- ▶ Tighten the cable gland to ensure tightness when done.

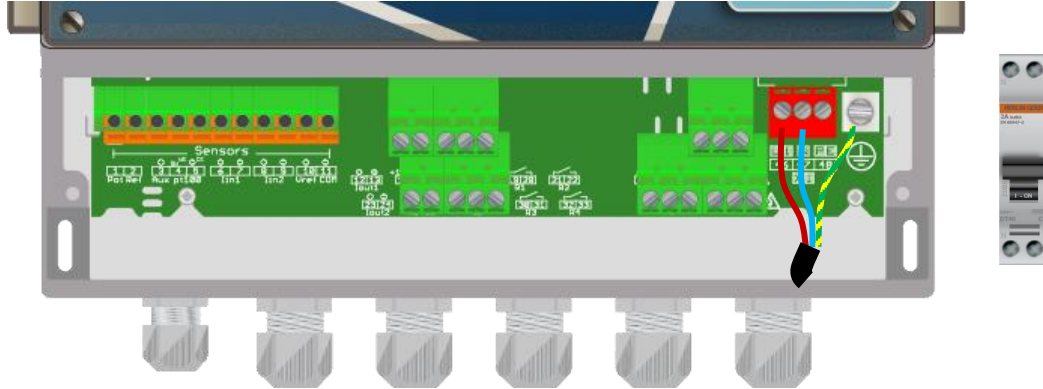

The **SYCLOPE TERE'O Touch**<sup>®</sup> controller does not have its own independent power switch. It is directly powered when connected to the main power supply.

#### 8) Connecting the self-powered control dosing relay

- Connecting the self-powered relay pH P3



The self-powered relay output P3 (Primary voltage = Available voltage on P3) is used to control the measurement parameter pH.



- ▶ Strip the 3 wires of dosing equipment for 7mm
- ▶ Pass the 3-point cable through a cable gland
- ▶ Wire the two wires to L1 (37) and N (38) located on **P3**
- ▶ Wire the ground cable on PE (39) located on **P3**
- ▶ Tighten the cable gland to ensure tightness when done.

- Connecting the self-powered relay Chlorine/Bromine P4

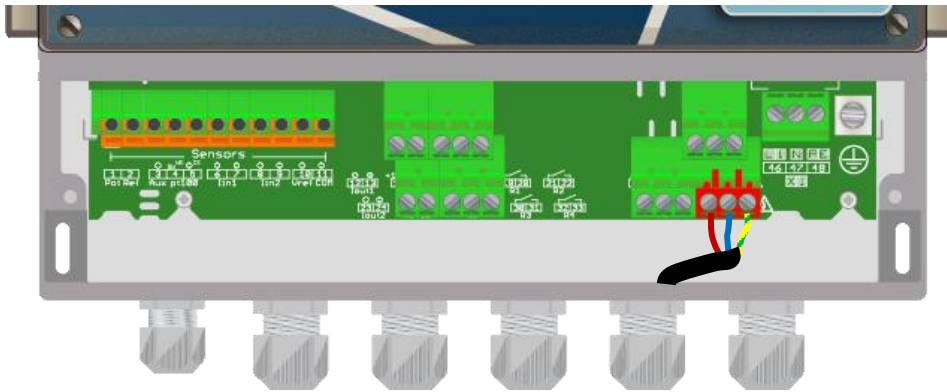

The self-powered relay output P4 (Primary voltage = Available voltage on P4) is used to control the measurement parameter Chlorine or Bromine.



- ▶ Strip the 3 wires of dosing equipment for 7mm
- ▶ Pass the 3-point cable through a cable gland
- ▶ Wire the two wires to L1 (43) and N (44) located on **P4**
- ▶ Wire the ground cable on PE (45) located on **P4**
- ▶ Tighten the cable gland to ensure tightness when done.

#### 9) Connecting the potential-free relay (P2)

The potential-free relay output can be used as an alarm relay or can be operated in Timer mode as needed.

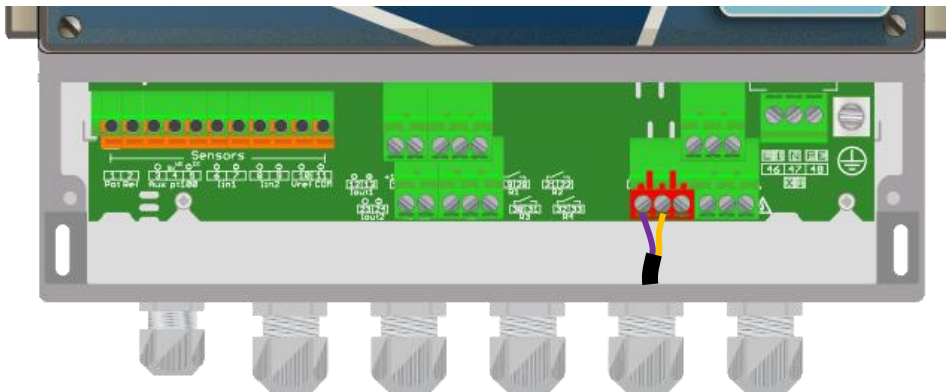

- ▶ Use a 2 wires cable with a cross section suitable for the voltage and current to be switched.
- ▶ Strip the 2 wires of dosing equipment for 7mm.
- ▶ Pass the 2 point cable through a cable gland.
- ▶ Wire the first wire in the middle point of the terminal block (**COMMON**)
- ▶ Wire the other one on the **WORK** or **REST** point according your application
- ▶ Tighten the cable gland to ensure tightness when done.

10) Connecting measurement inputs

The **TERE'O Touch**<sup>®</sup> has three inputs :

- POT input connection for pH sensor.
- In1 input 4-20mA input Insulated for temperature measurement.
- In2 input 4-20mA Isolated for chlorine or bromine measurement

## a) pH input

- ▶ Use the shield cable supplied with your sensor.
- ▶ Strip the wires for 7 mm.
- ▶ Pass the cable through a cable gland.
- ▶ Wire the center conductor to **Pot** (1) point.
- ▶ Wire the braided shield to **Ref** (2) point.
- ▶ Tighten the cable gland to ensure tightness

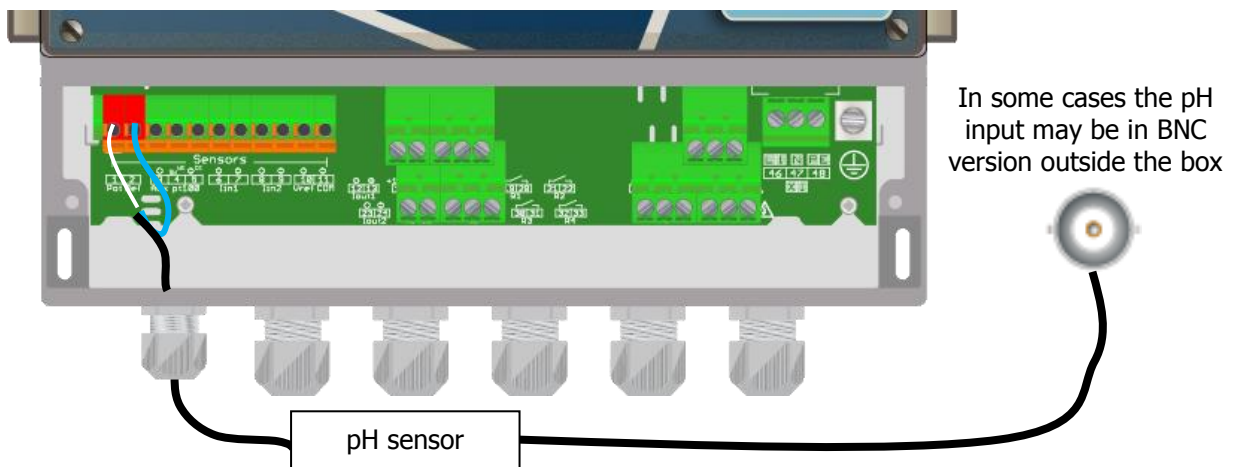

## b) Temperature input

- ▶ Use a 2 points cable.
- ▶ Strip the wires for 7 mm.
- ▶ Pass the cable through a cable gland.
- ▶ Wire the first point in the input **Iin1 (+) (6)**.
- ▶ Wire the second point in the input **Iin1 (-) (7)**.
- ▶ Tighten the cable gland to ensure tightness.

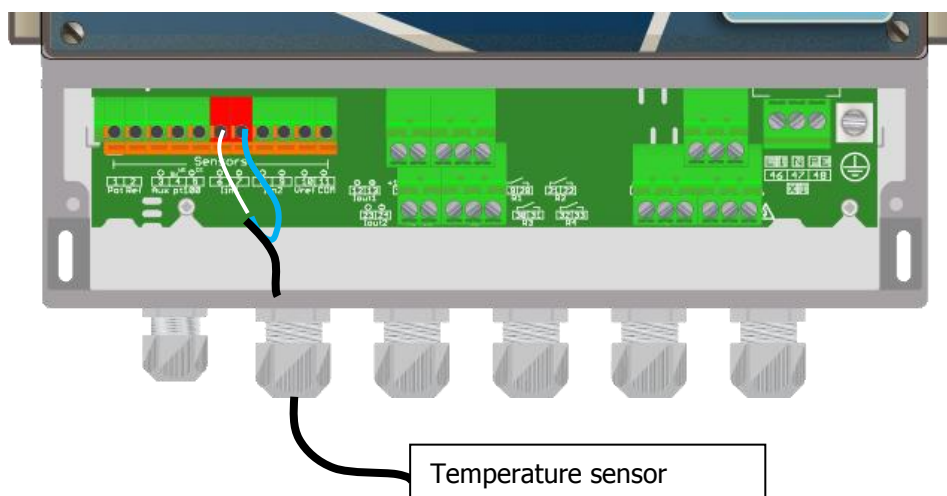

## c) Chlorine or Bromine input

- ▶ Use a 2 points cable.
- ▶ Strip the wires for 7 mm.
- ▶ Pass the cable through a cable gland.
- ▶ Wire the first point in the input **Iin2 (+) (8)**.
- ▶ Wire the second point in the input **Iin2 (-) (9)**.
- ▶ Tighten the cable gland to ensure tightness.

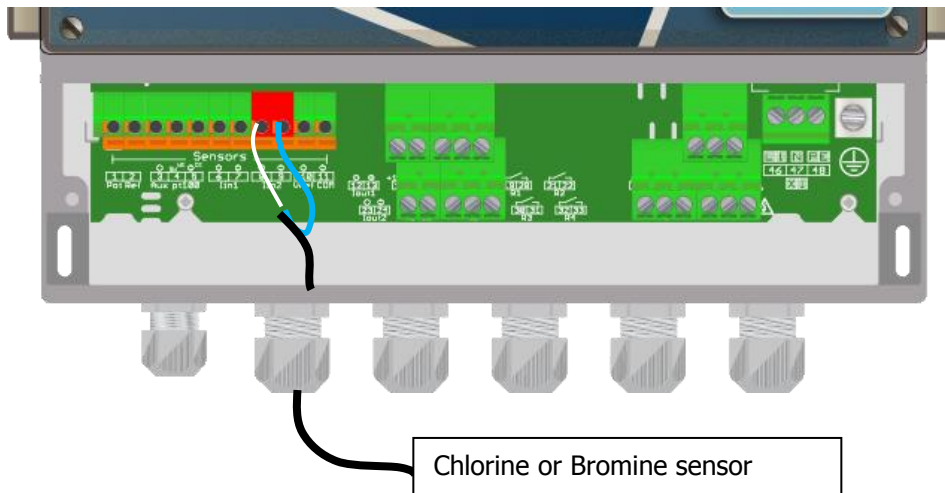

## d) Power output

If necessary, it is possible to use chlorine or bromine sensors requiring external power supply.

- ▶ Use a 2 points cable.
- ▶ Strip the wires for 7 mm.
- ▶ Pass the cable through a cable gland.
- ▶ Wire the + point in the input **Vref (10)**.
- ▶ Wire the - point in the input **Com (11)**.
- ▶ Tighten the cable gland to ensure tightness.

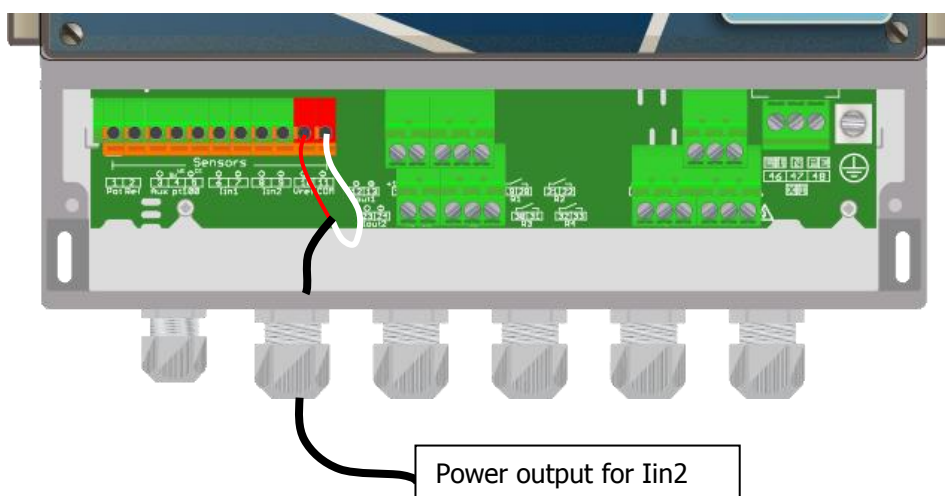

### 11) Connecting digital inputs

The **TERE'O Touch**<sup>®</sup> controller has a digital input (AUX) which can be used to remote control. This input is either an open/closed switch input used in a subservient manner to the main circulation pump of the filtration.



It is imperative to enslave the controller to the switch of the filtering group's motor to prevent damages caused by chemical overdoses!

#### a) Free of potential switch connection (flow switch, remote switch):

- ▶ Use a 2 points cable.
- ▶ Strip the wires for 7 mm.
- ▶ Pass the cable through a cable gland.
- ▶ Wire the two points of switch to **Aux (sw) (4)** and **Aux(-) (5)**.
- ▶ Tighten the cable gland to ensure tightness.

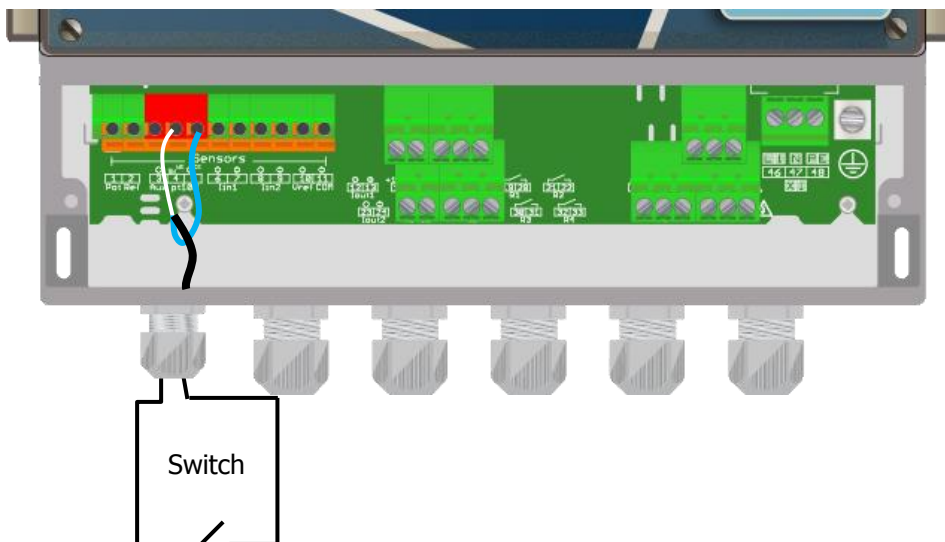

Your SYCLOPE **TERE'O Touch**<sup>®</sup> has a software configuration of the direction of contact. You can use either a NO or NC contact and select the type by programming.

#### b) Bipolar switch connection NPN :

- ▶ Strip the wires for 7 mm.
- ▶ Pass the cable through a cable gland.
- ▶ Wire the brown power wire to **Aux + (3)**.
- ▶ Wire the blue power wire to **Aux - (5)**.
- ▶ Wire the black contact wire to **Aux sw (4)**.
- ▶ Tighten the cable gland to ensure tightness.

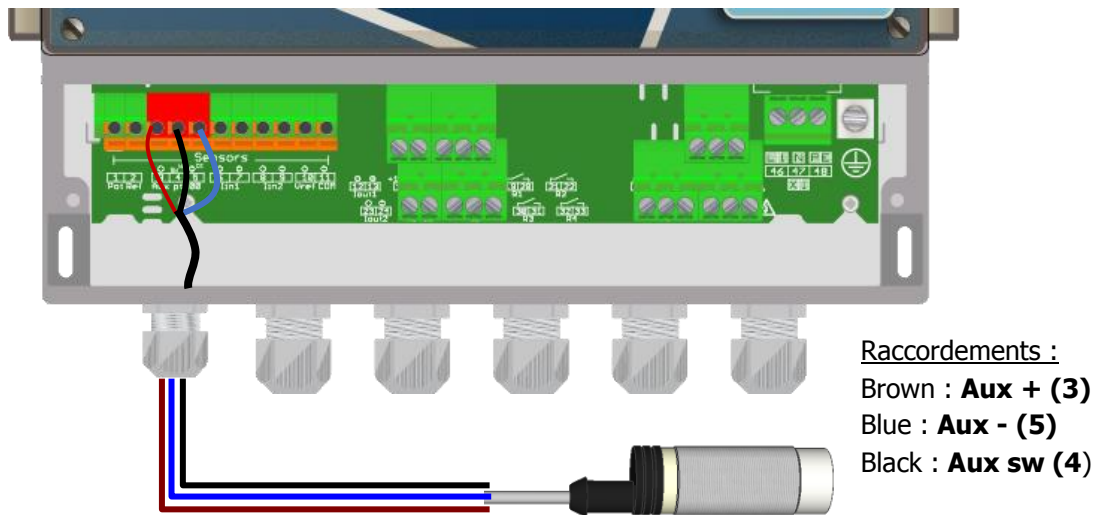

The inductive sensor supplied by SYCLOPE Electronics is NPN 3-wire type..

## 12) Connecting tank level switch

The **TERE'O Touch**<sup>®</sup> has two tank level inputs associated with the two dosing parameters. It is possible to control the dosing function and stop the injection when the tank is empty.



Your SYCLOPE **TERE'O Touch**<sup>®</sup> has a software configuration of the direction of contact. You can use either a NO or NC contact and select the type by programming.



Warning: tank level management is not enabled by default. Refer to the programming section of the manual to enable tank level management on the pH input and/or Chlorine / Bromine input.

### a) Tank level input pH (K1) :

- ▶ Use a 2 points cable.
- ▶ Strip the wires for 7 mm.
- ▶ Pass the cable through a cable gland.
- ▶ Wire the two points of switch to **K1 (+) (16)** and **K1(sw) (17)**.
- ▶ Tighten the cable gland to ensure tightness.

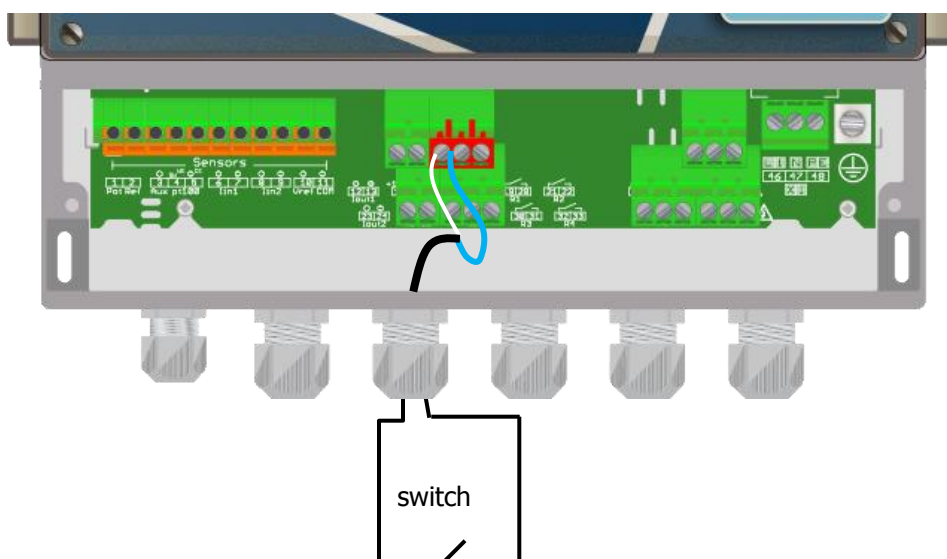

## b) Tank level chlorine/bromine (K2) :

- ▶ Use a 2 points cable.
- ▶ Strip the wires for 7 mm.
- ▶ Pass the cable through a cable gland.
- ▶ Wire the two points of switch to **K2 (+) (27)** and **K2 (sw) (28)**.
- ▶ Tighten the cable gland to ensure tightness.

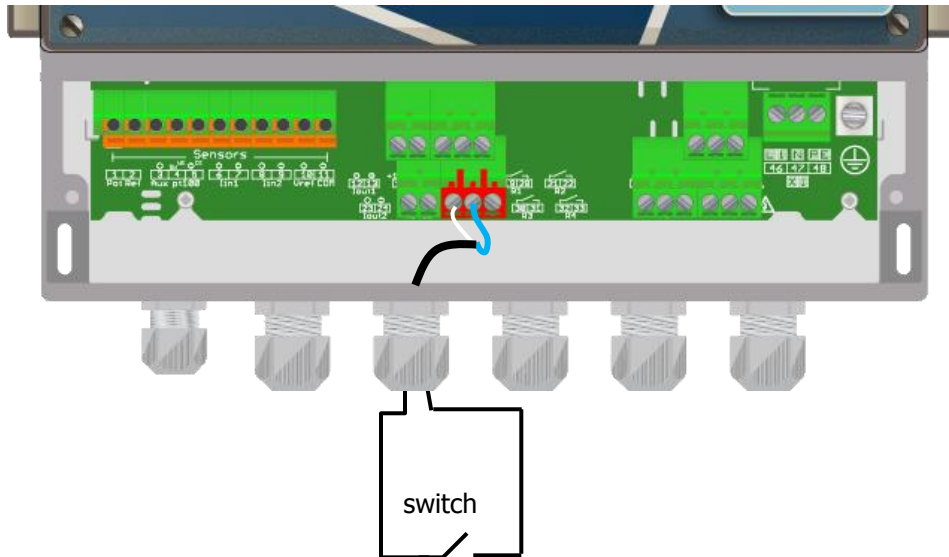
13) Connecting the RS485 communication por

The **TERE'O Touch**® controller has an RS485 communication port for linking a desktop computer equipped with the data-processing software which trace measurements, alarms, instructions.

## a) Connection to USB port of the computer

- ▶ Use a 3 points cable
- ▶ Strip the wires for 7 mm.
- ▶ Pass the cable through a cable gland.
- ▶ Wire AA' (n° 3) of the converter to **RS485 (A) (25)** terminal.
- ▶ Wire BB' (n° 4) of the converter to **RS485 (B) (26)** terminal.
- ▶ Wire C (n° 5) of the converter to **PWR (C) (15)** terminal
- ▶ Tighten the cable gland to ensure tightness.

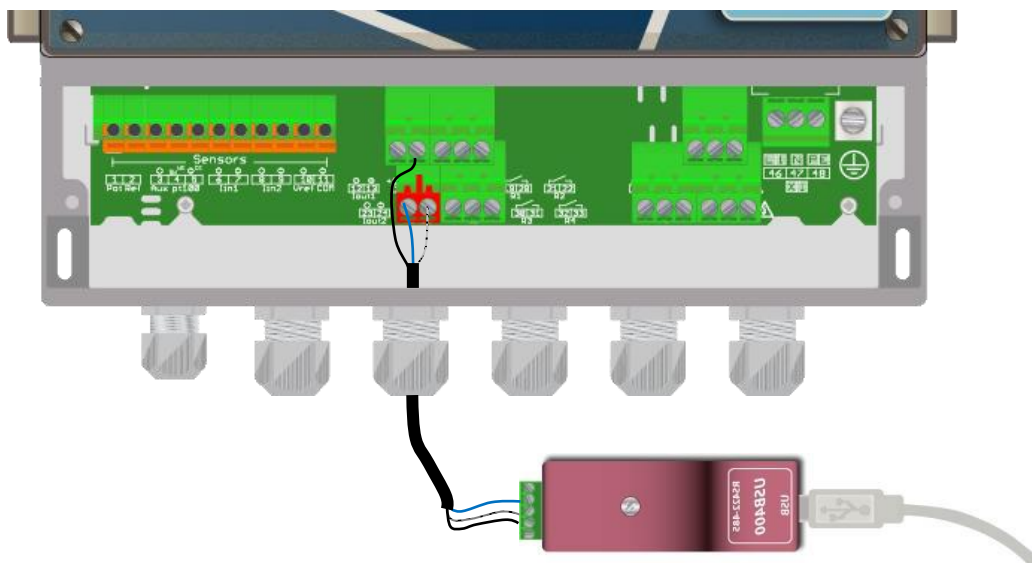

- Blue (Terminal block n°3) : AA' RS485
- White (Terminal block n°4) : BB' RS485
- Black (Terminal block n°5) : Ground RS485
- 



Configuration : All switches are **"ON"**

Please, contact us for further information on these products.



Respect the connection polarities of the bus.

We suggest using a USB/RS485 interface module to connect the **TERE'O Touch**® controller to your computer. Please consult the instructions of this converter for the connection.

Reference	Name
-----------	------

INF1021	USB => 485 Converter
---------	----------------------



The controllers can be chained by respecting the order of the cables (putting in parallel).

#### b) Polarization and termination of the RS485 bus

The bus can be polarized from your device if needed. To do this you have to switch both micro-switches on the electronic card Pol. RS+ (A) and Pol. RS- (B) on the ON position

If your device is the last of the line on the RS485 bus you can switch the Term switch. RS ON to enable line termination.

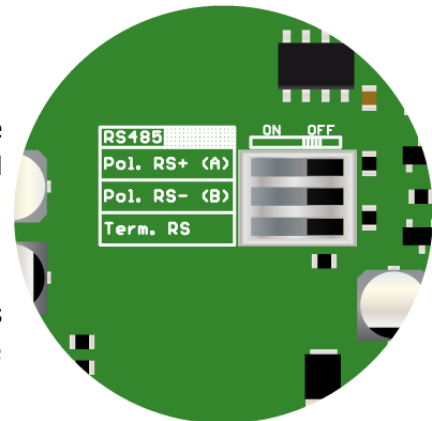

For safety reasons, it is imperative to cut the power supply of your **TERE'O Touch**® device before opening the case to switch the micro-switches!



## V. General use

The SYCLOPE **TERE'O Touch**® controller is intended to measurement and to control parameters for water treatment of swimming pools.



This type of installation is recommended in the event of single swimming pool where filtration circuit is independent.

- Water is sampled after the recirculating pumps and before the filter entry. (If using, before flocculent injection circuit)
- The sensors installed into the measuring chamber receive water to be analysed and send the values to the controller.
- According to the setting points fixed by the user, the controller sends proportional orders to the pumps installed into the main intake line of the swimming pool.

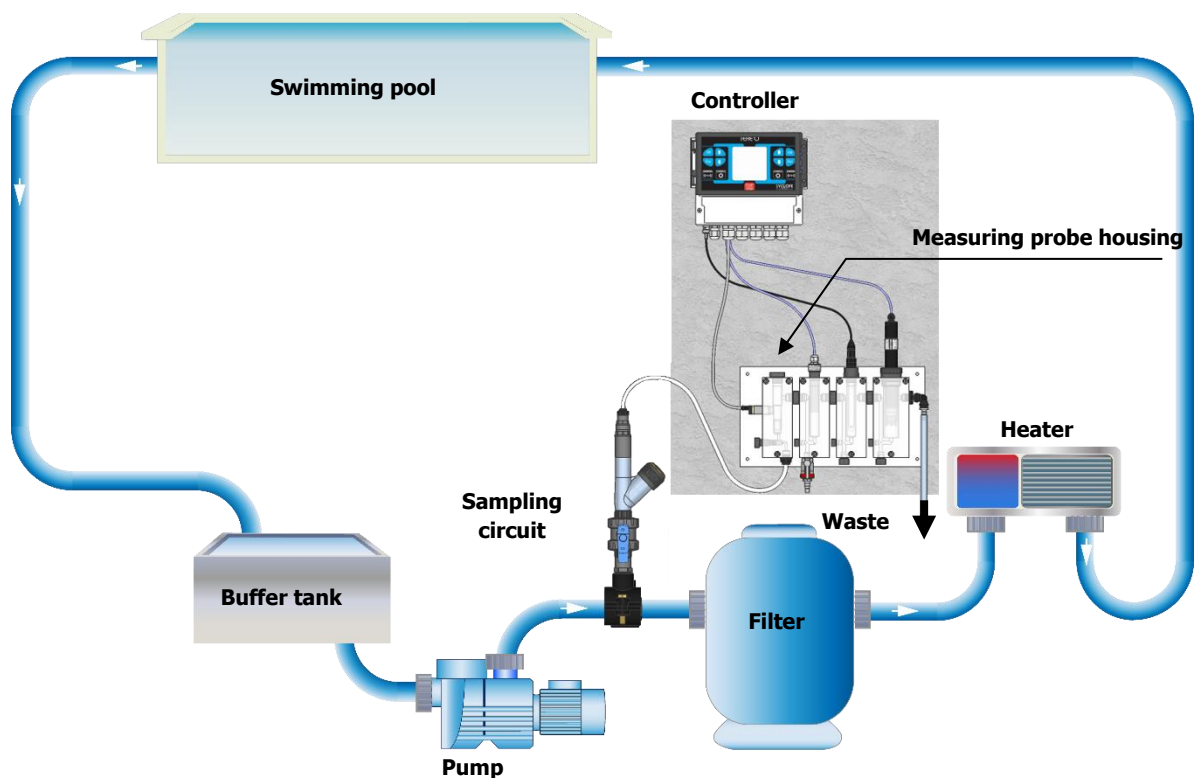

## VI. Commissioning

You have just carried out electrical connections, you have installed sensors and you have connected dosing equipment, you are thus ready to carry out the startup of your **SYCLOPE TERE'O Touch**® controller.



Apply the power supply on the controller  
Check if no visual problem appear, if the controller is well lit and if the other equipment of the installation are not disturbed.



**SYCLOPE TERE'O Touch**® controller does not launch automatically the chemistry treatments. The user is the main master for launching the controller after checking the good programming according the needs.

**SYCLOPE TERE'O Touch**® is full programmable. During the power up, the preset parameters are fixed and all regulation processes are inactive.



**SYCLOPE TERE'O Touch**® controller is delivered with standard programming. It is advisable for the user to modify this programming if it does not correspond to the needs. To modify the programming of the controller, please refer to the following chapter.

## VII. Programming the controller

**TERE'O Touch**® controllers are equipped with a touch-sensitive color graphic display, so all programming actions are performed by pressing the display. The technology of the touch screen is resistive type, it is necessary to make a firm pressure on the screen to validate the keys.



Ensure the good programming of the **TERE'O Touch**® controller before starting regulations!  
An excess of chemical products can cause harmful actions on the human health and the environment.

### 1) Principal display

The display is made by a backlit 3.5-inch color graphic display separate into three main parts :

The upper panel

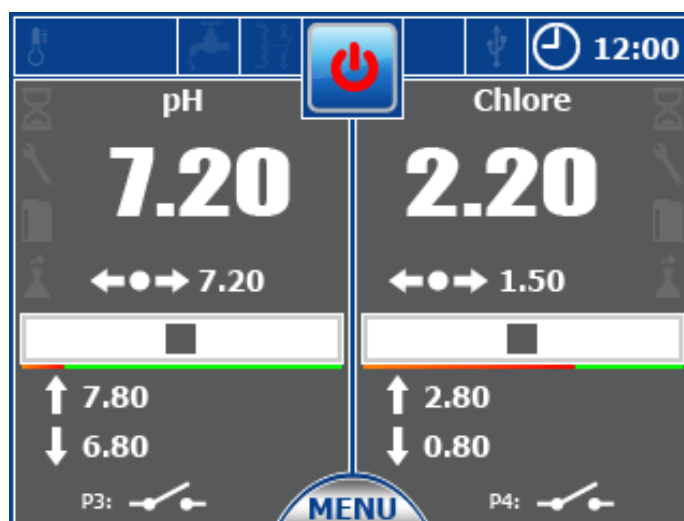

The left panel for  
pH measurement

The right panel for  
chlorine or Bromine  
measurement

a) The upper panel

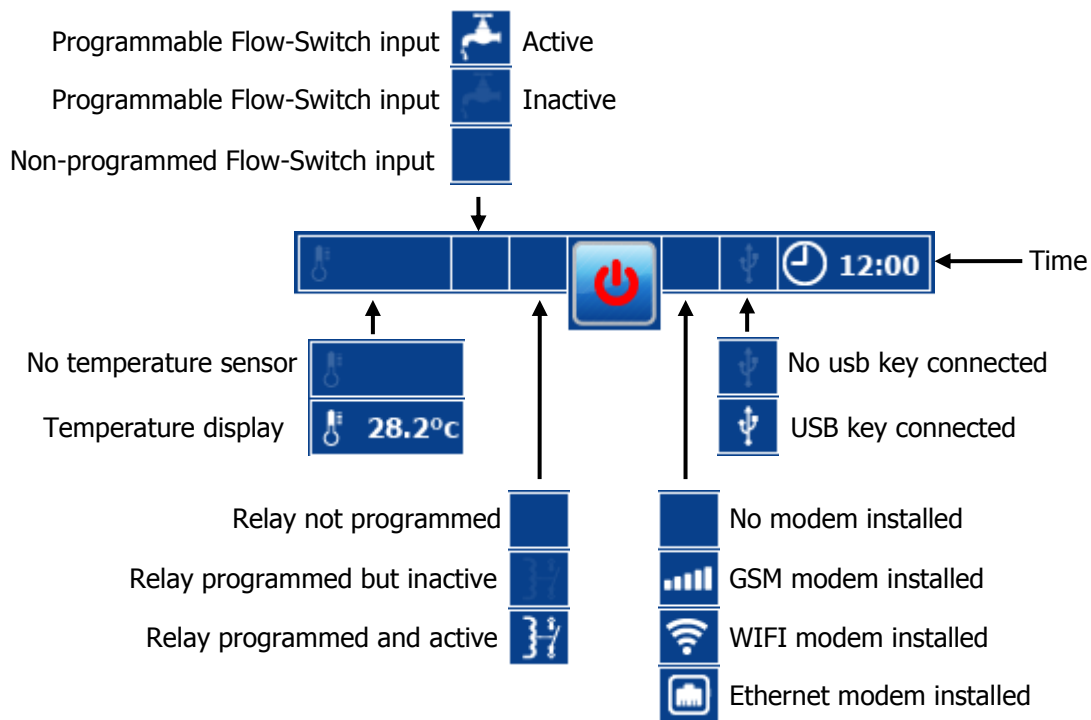

**On / Off control button**



Pressing on this area of the screen stop or start your controller

b) Display of a measurement channel

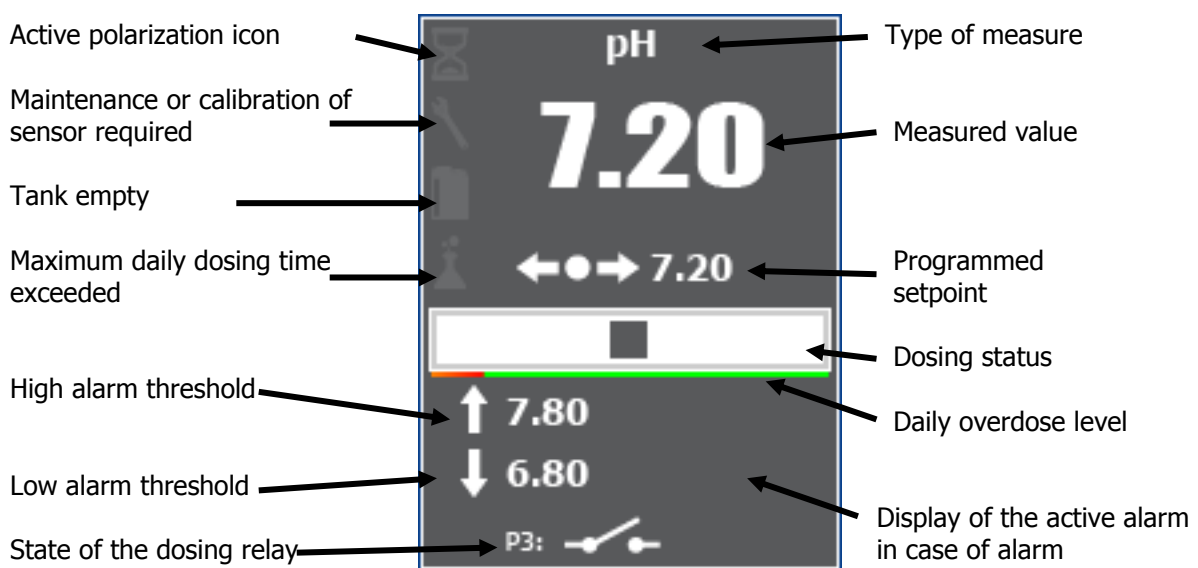

c) Touch zone of a measurement channel

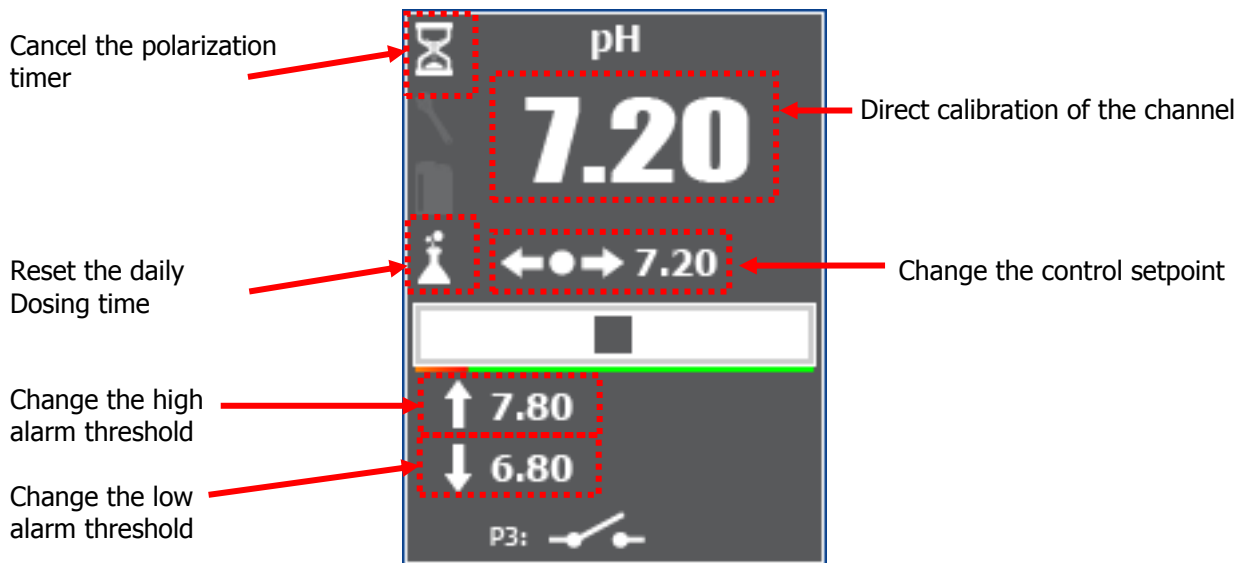

Attention direct calibration is only possible if the system is in START mode !

d) The bottom menu

The bottom menu is displayed when the "Menu" key is pressed, and gives access to the User menu, depending on the START / STOP state of the controller. The "pump" keys can be grayed out.

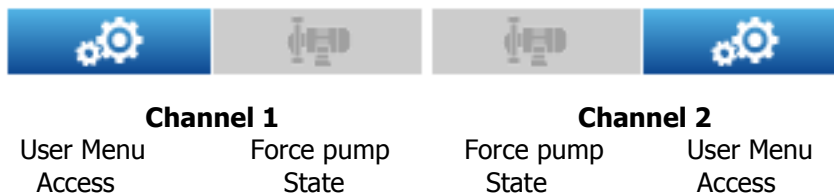

2) Input mode

The controller has several input modes depending on the type, list, numeric or alphanumeric.

a) Mode « List »

When a programming element proposes a list of choices, this type will be displayed with two arrows and a central indication area of the selected element.

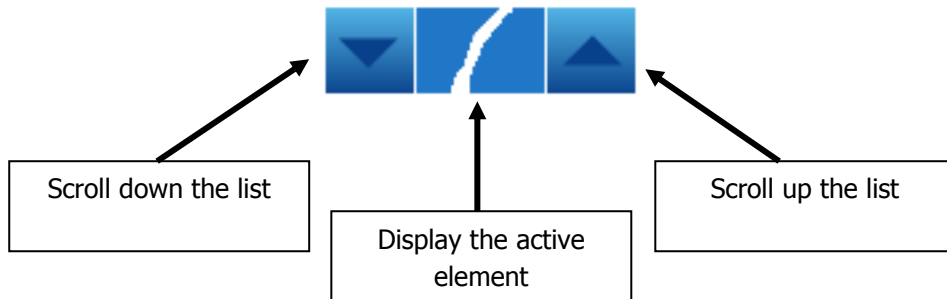

b) Mode « numeric »

When a programming element is numeric, a numeric keypad appears when typing.

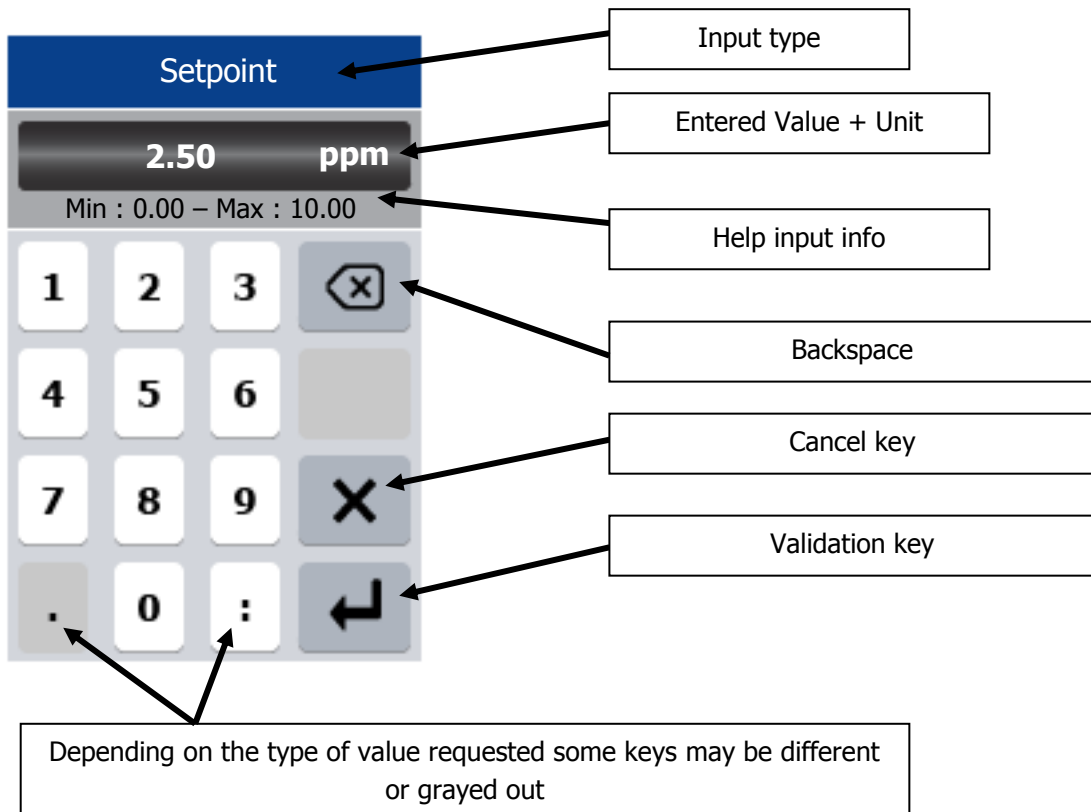



In the case of an input error or out-of-range value, the "Min - Max" indication area will be highlighted in red.

c) Mode « alphanumeric »

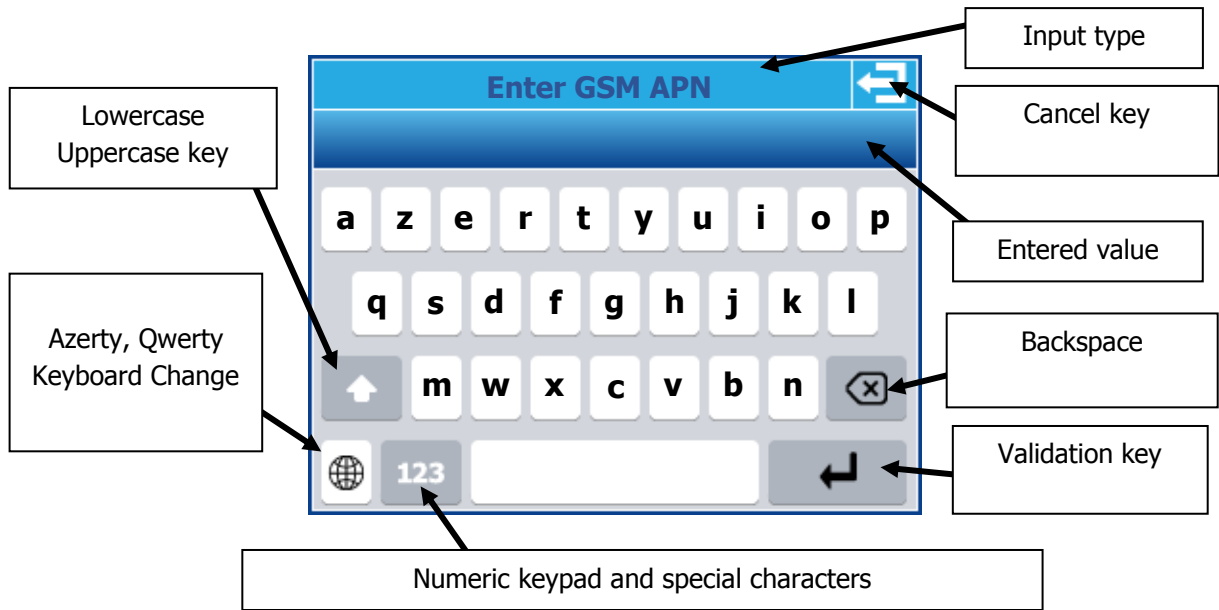
When a programming element is alphanumeric keypad appears when typing.



Press on  toggle in uppercase, a second press locks the keyboard in uppercase 



To display the accented characters you must hold the corresponding unaccented character key pressed to bring up the list of characters, move your finger from left to right and release on the desired character.



Numeric keypad

Special characters keyboard



Character pad display key

Press on  to toggle the display of special characters 

### 3) Programming Menu « Installer »

The installer programming menu allows the general programming of your **TERE'O Touch®** controller.

To open the programming menu press the menu button for 3 seconds. When the message "INSTALLER" appears, you can release the button.

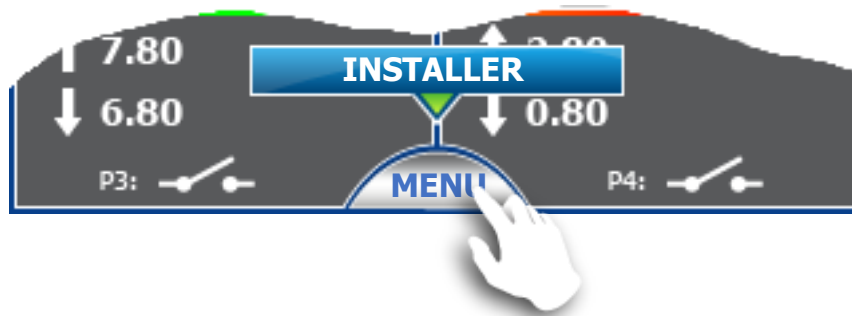

When the "MENU" button is released, the general programming screen appears. You must then, depending on the need, choose the programming to be done.

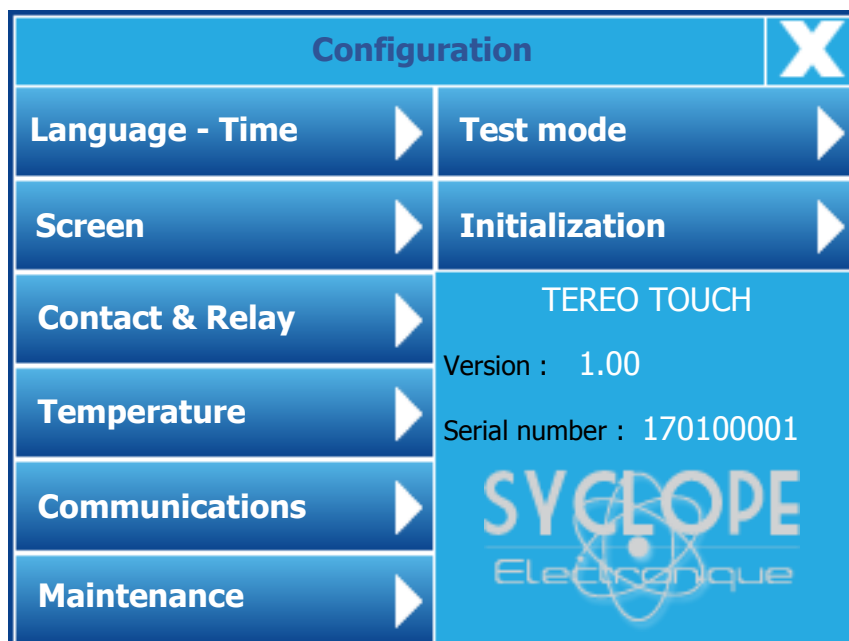

The programming screen closes automatically after 60 seconds without action.

a) Language and Time

Pressing the « Language – Time » button opens the programming window.

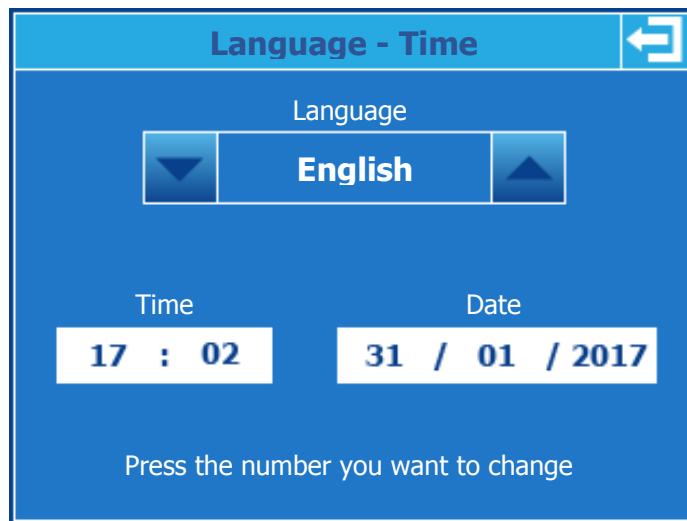

- **Change language:**  
Use the buttons on both side of the selection area to scroll through the languages in one direction or the other.
- **Change Time :**  
Press the time to open the keyboard.
- **Change Date :**  
Press the date to open the keyboard.



The validation of the changes is done only when you leave the screen by pressing the return key at the top left.

b) Screen

Pressing the « Screen » button opens the programming window.

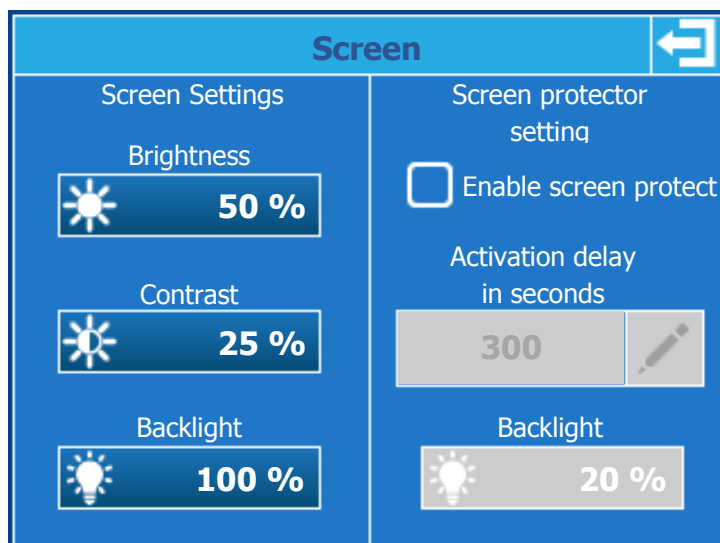



The brightness, contrast and backlight settings are made by moving the adjustment slider from left to right while pressing and holding it.



- **Change brightness :**  
Press the button to open the cursor window, then move the cursor from left to right to make your adjustment.
- **Change contrast :**  
Press the button to open the cursor window, then move the cursor from left to right to make your adjustment.
- **Change backlight :**  
Press the button to open the cursor window, then move the cursor from left to right to make your adjustment.
- **Enable screen protect :**  
Check or uncheck the box to change its state. When the box is checked the screen protection is active and you can change the delay and the backlight level.
- **Change the activation time of the screen protector :**  
Press the button to open the numeric entry keypad.
- **Change the backlight in « screen protection » mode :**  
Press the button to open the cursor window, then move the cursor from left to right to make your adjustment.



The screen protection activation time corresponds to the time during which there will be no press on the screen.

### c) Contact & Relay

Pressing the « Contact & Relay » button opens the programming window.

Contact & Relay	
<p>Flow-Switch configuration</p> <p><input type="radio"/> <b>Not used</b></p> <p><input type="radio"/> <b>Active - NO</b></p> <p><input checked="" type="radio"/> <b>Active - NF</b></p> <p>Activation delay in seconds</p> <div style="border: 1px solid white; padding: 5px; display: inline-block; text-align: center;">5</div>	<p>Output relay configuration</p> <p><input checked="" type="radio"/> <b>Not used</b></p> <p><input type="radio"/> <b>Active on timer</b></p> <p><input type="radio"/> <b>Active on alarm</b></p>

➤ **Change the flow contact :**

If you are using a water flow-switch contact, you must select the operating mode by pressing the desired mode (Normally Open - Normally Closed).

If the contact is active you can then enter its activation delay (delay take in account when is state change).

➤ **Change the contact activation delay :**

Press the button to open the numeric entry keypad.

➤ **Change the relay configuration :**

If you want to use the third relay output either alarm or timer you have to select the desired mode.

In the timer version, a timer adjustment button appears to access the relay's time setting.



➤ **Timer screen :**

Timer						
<input type="checkbox"/> One timer for the entire week						
Mon.	Tue.	Wed.	Thu.	Fri.	Sat.	Sun.
Start time			End time			
00 : 00			T1	00 : 00		
00 : 00			T2	00 : 00		
00 : 00			T3	00 : 00		

➤ **One timer for the entire week :**

By checking this box you can then program three timers that will happen every day of the week.

➤ **Day of the week selection :**

If you use different timers depending on the days of the week, you have to select day after day and set for each day the start and end times.

➤ **Hours setting :**

If you use different timers depending on the days of the week, you have to select day after day and set for each day the start and end times.

**When the entry is invalid the time slot is displayed in red**



**When the entry is valid the time slot is displayed in green**



d) Temperature

Pressing the « Temperature » button opens the programming window.

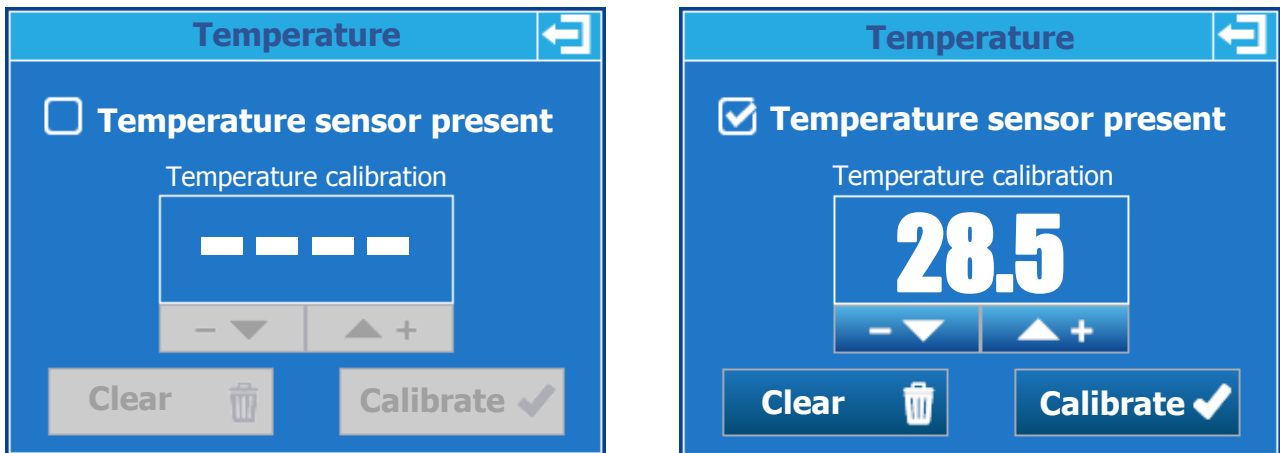

➤ **Temperature sensor :**

By checking this box, the temperature measurement input is activated. The measured value will be displayed on the main screen.

➤ **Temperature sensor calibration :**

Once the sensor is activated you can calibrate it by changing the displayed value (read by the sensor) and the actual value you are measuring. To do this, use the + and - arrows to increase or decrease the value.

- Press the calibrate button to save your changes.
- Press the Clear button to erase a saved calibration.

e) Communications

Pressing the « Communication » button opens the programming window.

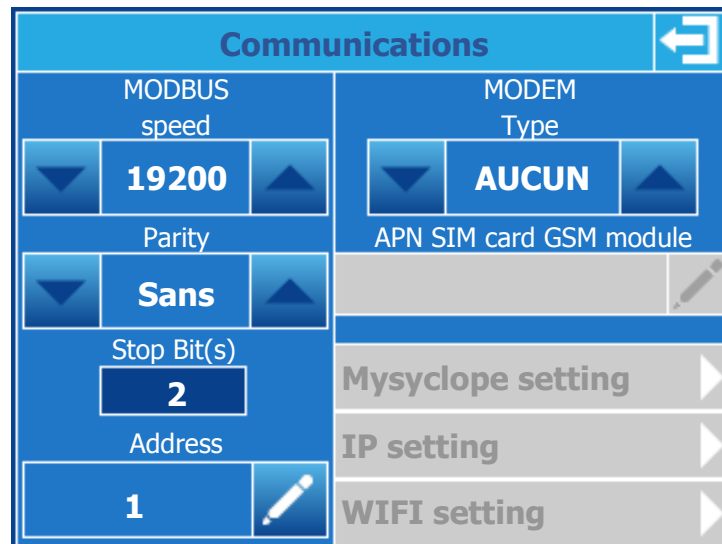

**MODBUS section (Local communication RS485 port)**

➤ **Change MODBUS speed:**

Use the buttons on either side of the selection area to scroll through the different speeds in one direction or the other (300, 1200, 2400, 4800, 9600, 19200, 38400, 57600, 115200).

- **Change MODBUS parity :**  
Use the buttons on either side of the selection box to scroll through the different parities in one direction or the other (None, Even, Odd).
- **Stop bit(s) information :**  
This part is not modifiable and is automatically configured according to the choice of parity that is made.
  - 2 for a communication without parity.
  - 1 for communication with even or odd parity.
- **Change MODBUS address :**  
Press the button to open the numeric keypad and enter the new address.

**Section MODEM (Communication avec site web mysyclope)**

- **Change Modem type :**  
Use the buttons on either side of the selection area to scroll through the different parities (NO, GSM, Ethernet, WIFI) in one direction or the other.  
Depending on the type of modem selected, the shaded areas below become accessible in configuration.

MODEM Type	MODEM Type	MODEM Type
<div style="border: 1px solid black; padding: 5px; display: inline-block;"> <div style="display: flex; justify-content: space-between; width: 100%;"> <span>▼</span> <span><b>GSM</b></span> <span>▲</span> </div> <p>APN SIM card GSM module</p> </div>	<div style="border: 1px solid black; padding: 5px; display: inline-block;"> <div style="display: flex; justify-content: space-between; width: 100%;"> <span>▼</span> <span><b>Ethernet</b></span> <span>▲</span> </div> <p>APN SIM card GSM module</p> </div>	<div style="border: 1px solid black; padding: 5px; display: inline-block;"> <div style="display: flex; justify-content: space-between; width: 100%;"> <span>▼</span> <span><b>WIFI</b></span> <span>▲</span> </div> <p>APN SIM card GSM module</p> </div>
m2minternet		
<b>Mysyclope setting</b> ▶	<b>Mysyclope setting</b> ▶	<b>Mysyclope setting</b> ▶
IP setting ▶	IP setting ▶	IP setting ▶
WIFI setting ▶	WIFI setting ▶	WIFI setting ▶

- **Change SIM card APN in GSM mode :**  
Press the button to open the keypad and enter the APN corresponding to your m2m GSM card provider. The maximum size is 30 characters.
- **MYSYCLOPE configuration**

**Mysyclope**

Server address

**www.mysyclope.com**

TCP port

**18880**

Remote code

**1234**

**Synchronize the date and time**

- **Change server address :**  
Press the button to open the keyboard and enter the address of the mysyclope server. The maximum size is 30 characters.
- **Change TCP port :**  
Press the button to open the numeric keypad and enter the TCP port of the mysyclope server.
- **Change remote code:**  
Press the button to open the numeric keypad and enter the new remote code
- **Synchronize la date and timer :**  
When your system is connected, by ticking this box, the controller will be set automatically by the website as soon as necessary.

- **Ethernet configuration**

IP <span style="float: right;">←</span>	
<input type="checkbox"/> <b>DHCP Active</b>	<input type="checkbox"/> <b>DNS Automatic</b>
IP address	Prefered DNS
<b>192 . 168 . 1 . 2</b>	<b>8 . 8 . 8 . 8</b>
Mask	Auxillary DNS
<b>255 . 255 . 255 . 0</b>	<b>8 . 8 . 4 . 4</b>
Gateway	
<b>192 . 168 . 1 . 200</b>	
Press the number you want to change	

- **DHCP Active :**  
If the local Ethernet network on which the controller is connected has a DHCP that automatically distributes IP addresses, you must check this box. In this case the IP, Mask and Gateway configurations will be automatic.
- **IP address :**  
Address your controller on your local Ethernet network. Press the input box to open the numeric keypad and enter the IP provided by your IT manager.
- **Mask & Gateway :**  
Same as previous.
- **DNS Automatic :**  
If the local Ethernet network on which the controller is connected is automatically distributing DNS you must check this box. In this case the DNS configurations will be automatic.
- **Prefered DNS :**  
DNS server address. Press the input box to open the numeric keypad and enter the IP provided by your IT manager.
- **Auxillary DNS :**  
Same as previous.



➤ **WIFI Configuration**

The image shows a touch-screen interface for configuring a WiFi network. The background is blue. At the top, there's a header with the word 'WIFI' in white and a white back arrow icon. Below the header, there's a white text input field labeled 'SSID' with a white pencil icon on the right. Underneath the SSID field, there are two dropdown menus. The first is labeled 'Country code' and has 'ETSI' selected. The second is labeled 'Mode' and has 'Infra.' selected. Below these, there's a third dropdown menu labeled 'Security' with 'Désactivée' selected. At the bottom, there's a white text input field labeled 'Security key' with a white pencil icon on the right.

- **SSID :**  
Name of the WIFI network you want to connect to. To change it, press the enter button to open the alpha numeric keypad and enter the name of your network.
- **Country code :**  
Press the arrows to change the code to your country.  
**ETSI** = Europe
- **Mode :**  
Press the arrows to change the network mode.  
- **Infra.** = Network on which multiple elements can connect.  
- **Ad-Hoc** = Network on which only the regulator will be connected.
- **Security :**  
Press the arrows to select the security mode of your WIFI network. Depending on the latter, you will have to enter the corresponding security key.
- **Security key :**  
If the network is secure and you have selected the security type in the previous step, tap the entry box to open the alpha numeric keypad and enter the security key for your network.

f) Maintenance

Pressing the « Maintenance » button opens the programming window.

Maintenance			
<b>POT :</b>	<b>-10</b> mV	<b>7.18</b> pH	
- pH		- Offset : 0mV – Gain : 100%	
<b>IN1 :</b>	<b>13.0</b> mA	<b>23.26</b> °C	
- Temperature		- Offset : 0.0mA – Gain : 100%	
<b>IN2 :</b>	<b>11.2</b> mA	<b>6.04</b> ppm	
- Chlorine		- Offset : 0.0mA – Gain : 100%	
<b>K1 :</b>		Inactive	Active - NC
- pH tank level			
<b>K2 :</b>			Not used
- Chlorine tank			
<b>FLW :</b>		Active	Active - NC
- Flow-Switch			

➤ **POT measurement inputs :**

This input corresponds to the pH measurement input. The raw measurement value (in mV) can be read, the pH value corresponding to the adjusted measurement of the calibration. The Offset and Gain information correspond to the calibration of the sensor (0mV & 100% correspond to an uncalibrated sensor).

➤ **IN1 measurement inputs :**

This input corresponds to the measurement input of the temperature. You can read the raw measurement value (in mA), the value of the temperature corresponding to the adjusted calibration measurement. The Offset and Gain information correspond to the calibration of the sensor (0mA & 100% correspond to an uncalibrated sensor).

➤ **IN2 measurement inputs :**

This input corresponds to the measurement input of Chlorine or Bromine. The gross measurement value (in mA), the value of Chlorine or Bromine corresponding to the adjusted measurement of the calibration can be read. The Offset and Gain information correspond to the calibration of the sensor (0mA & 100% correspond to an uncalibrated sensor).

➤ **K1 Dry contact input:**

This entry corresponds to the entry dedicated to the tank level pH channel. Depending on the configuration of the input you can see its status and type of configuration.

➤ **K2 Dry contact input:**

This entry corresponds to the entry dedicated to the tank level chlorine/Bromine channel. Depending on the configuration of the input you can see its status and type of configuration.

➤ **FLW Dry contact input :**

This input corresponds to the entrance dedicated to the flow of water in the measuring chamber. Depending on the configuration of the input you can see its status and type of configuration.



This screen is constantly updated.

g) Test Mode

Pressing the « Test Mode » button opens the programming window.

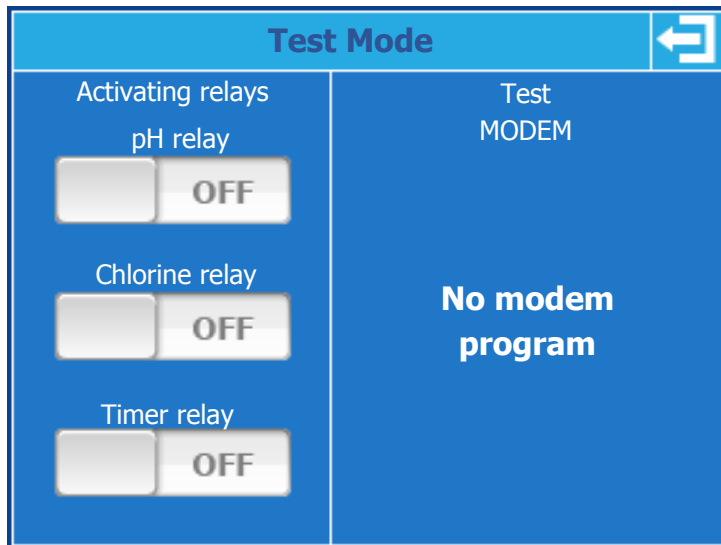

➤ **Activating relays :**

It is possible to activate the relays one by one and to force their state to test the wiring, to do this simply press the corresponding relay button.



➤ **Modem test :**

Depending on the presence or absence of a Modem (GSM, Ethernet, WIFI), it is possible to know the status and type of modem installed.

➤ **GSM Modem :**

▪ PIN code messages

- **Searching...** : Waiting for the Modem module answer.
- **Error** : No answer from the modem, check the hardware connection of the module.
- **PIN requested** : A PIN is needed.
- **PUK requested** : A PUK is needed.
- **PIN2 requested** : A PIN2 is needed.
- **PUK2 requested** : A PUK2 is needed.
- **OK** : Correct answer expected by the system.



The SIM card must not have a programmed PIN. In case of error message of the type "code required" please disable the code of your card.

▪ Network status messages

- **Searching ...** : Waiting for the Modem module answer.
- **Error** : No answer from the modem, check the hardware connection of the module.
- **Refuse** : Network access problem, check your APN and contact the SIM card provider.
- **Connected** : Correct answer expected by the system.



- Signal level messages
  - **Searching ...** : Waiting for the Modem module answer.
  - **Error** : No answer from the modem, check the hardware connection of the module.
  - **Low** : No sufficient level to make the connection.
  - **Medium, Good, Excellent** : Correct answer expected by the system.
  
- **Ethernet Modem :**
  - State messages
    - **Searching...** : Waiting for the Modem module answer.
    - **Error** : No answer from the modem, check the hardware connection of the module.
    - **Waiting** : Waiting for network connection.
    - **Negotiation** : Connection in progress.
    - **Authentication** : Connection in progress.
    - **Disconnecting** : Disconnecting in progress.
    - **Disconnected** : System not connected, check your TCP/IP configuration
    - **Connected** : Correct answer expected by the system.
  
  - IP messages
    - **Searching...** : Waiting for the Modem module answer.
    - **Error** : No answer from the modem, check the hardware connection of the module.
    - **xxx.xxx.xxx.xxx** : Current IP of your controller, a value other than 0.0.0.0 is correct.
  
- **WIFI Modem :**
  - State messages
    - **Searching...** : Waiting for the Modem module answer.
    - **Error** : No answer from the modem, check the hardware connection of the module.
    - **Waiting** : Waiting for network connection.
    - **Negotiation** : Connection in progress.
    - **Authentication** : Connection in progress.
    - **Disconnecting** : Disconnecting in progress.
    - **Disconnected** : System not connected, check your TCP/IP & WIFI configuration
    - **Connected** : Correct answer expected by the system.
  
  - IP messages
    - **Searching...** : Waiting for the Modem module answer.
    - **Error** : No answer from the modem, check the hardware connection of the module.
    - **xxx.xxx.xxx.xxx** : Current IP of your controller, a value other than 0.0.0.0 is correct.
  
  - Signal level messages
    - **Searching...** : Waiting for the Modem module answer.
    - **Error** : No answer from the modem, check the hardware connection of the module.
    - **Low** : No sufficient level to make the connection.
    - **Medium, Good, Excellent** : Correct answer expected by the system.

h) Initialization

Pressing the « Initialization » button opens the programming window.

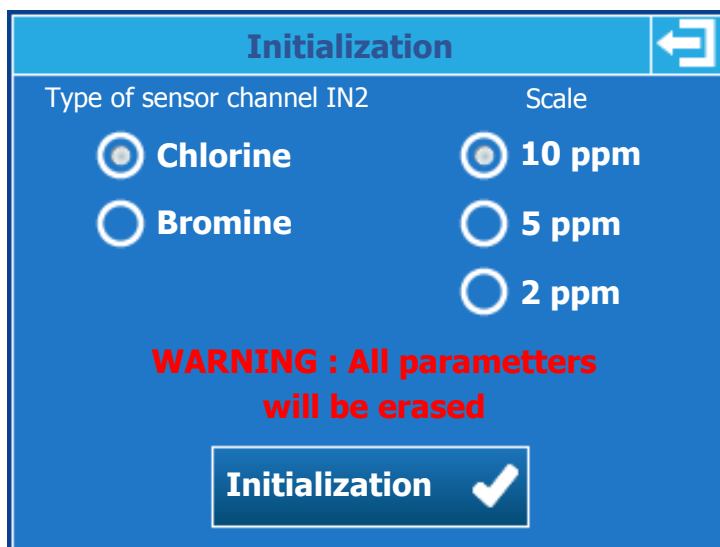

Type of sensor channel IN2	Scale
<input checked="" type="radio"/> Chlorine	<input checked="" type="radio"/> 10 ppm
<input type="radio"/> Bromine	<input type="radio"/> 5 ppm
	<input type="radio"/> 2 ppm

**WARNING : All parametters will be erased**

Initialization ✓

- **Type of sensor channel IN2 :**  
Select the desired type of sensor.
- **Scale :**  
Select the sensor scale.
- **Initialization button :**  
When you press the button a confirmation window opens to confirm your choice.  
WARNING all settings and configurations will be reset to factory Version.



- **Yes button :**  
Confirm the reset of the controller with the selected parameters.
- **NO button :**  
Cancel controller reset.

### VIII. Parameter setting

The user programming menu allows the programming of each measuring channel of your TERE'O TERE'O Touch®.

To open the programming menu, press the menu button. When the "USER" message appears you can release the button.

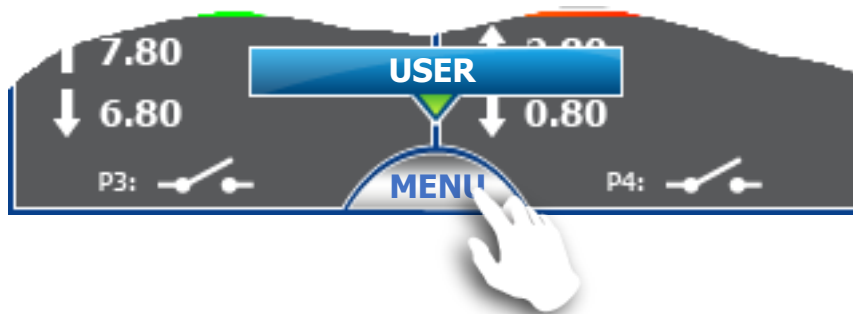

The channel selection menu to be programmed opens, you must choose the channel you want to configure by pressing the left button for the pH channel and right for the Chlorine / Bromine channel.



The programming menu of the chosen channel opens (here pH), gives access to the functions of parameter settings of the channel.



The programming screen closes automatically after 60 seconds without action.



During the programming or while the menu is open the channel is put in pause and the dosing is stopped.

1) Tank level

Pressing the « Tank level » button opens the programming window.

- **Program the tank level :**  
If you are installing a tank level contact, it is necessary to set its operating mode by pressing the corresponding mode.
- **Stop dosing on tank low :**  
If this box is checked the dosage will be stopped when the bottom of the tank is detected.  
In the case where your regulator is connected on the mysyclope site you can choose not to stop the dosing and to send you an alarm email from the site.



Stop dosing option is not displayed if « Not used » mode is selected.

a) Alarms

Pressing the « Alarms » button opens the programming window.

- **Change low & high alarm :**  
Press the button corresponding to the value to be modified to open the numeric keypad and enter the new alarm threshold.
- **Stop dosing on alarm :**  
If this checkbox is checked the dosage will be stopped when an alarm is active.



Alarms are active only when your controller is in START mode and the polarization timer is not active.

2) Control

Pressing the « Control » button opens the programming window.

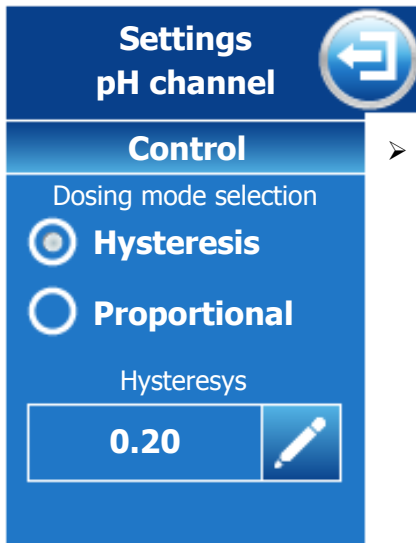

➤ **Change dosing mode :**

- The proportional mode allows to regulate according to a linear calculation, the control of dosage is calculated only from the component « Proportional ».
- The hysteresis mode is an ON / OFF type control. The hysteresis value is the difference between the set point and the measuring point where the actuator will be activated.  
When the measured value is higher than the high point, the actuator that allows the value to be reduced is activated.  
When the measured value is lower than the low point, the actuator for increasing the measured value is activated.  
Between the set point and the high or low point, the previously activated actuator remains on

➤ **Enter the hysteresis or proportional value :**

Press the enter button to open the numeric keypad and enter the new one the new value.

**When the dosing direction of the pH channel is configured in downstream mode.**

- In proportional mode, when the error (setpoint - measurement) is equal to the proportional band, the control requirement is 100%, by reducing the value of the proportional band, you increase the dosing control for the same measurement value.

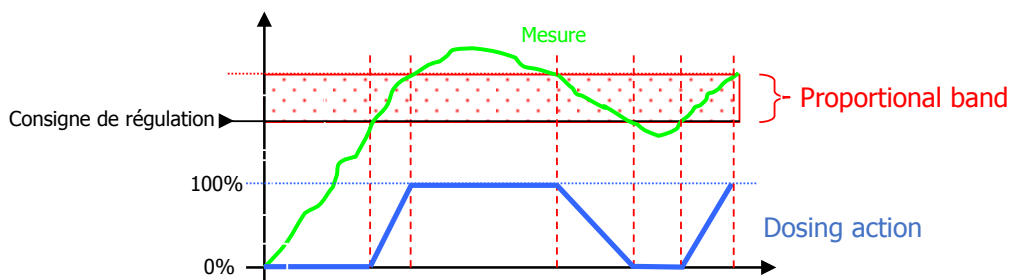

- In hysteresis mode, as soon as the error (setpoint - measurement) is greater than the hysteresis value, the regulation requirement is 100%.

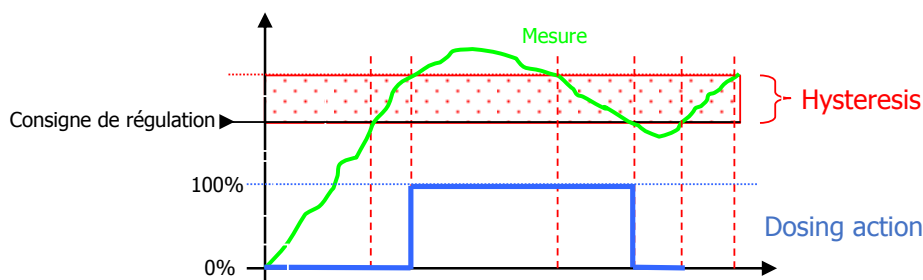

**When the dosing direction of the pH channel is configured in upstream mode.**

- In proportional mode, when the error (setpoint - measurement) is equal to the proportional band, the control requirement is 100%, by reducing the value of the proportional band, you increase the dosing control for the same measurement value.

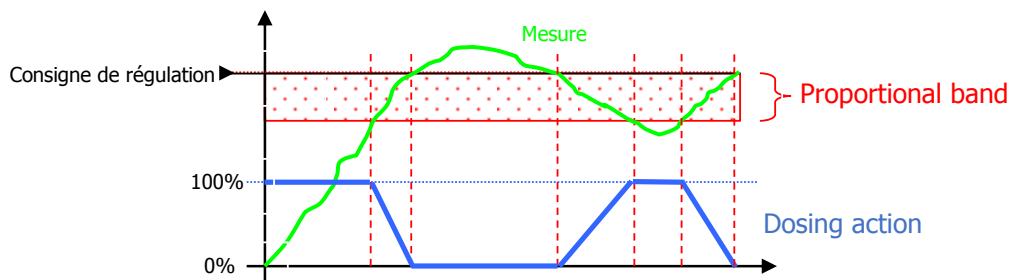

- In hysteresis mode, as soon as the error (setpoint - measurement) is greater than the hysteresis value, the regulation requirement is 100%.

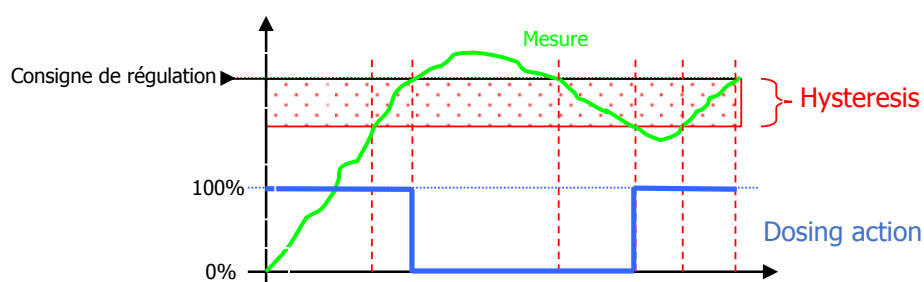

### 3) Dosing

Pressing the « Dosing » button opens the programming window.

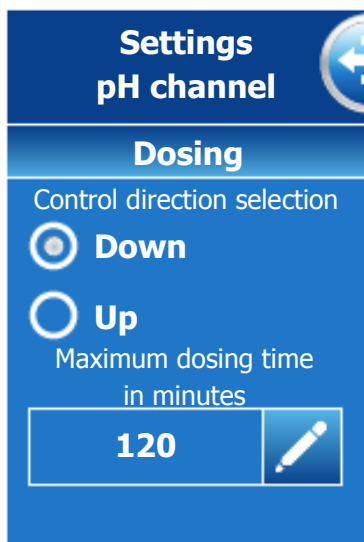

- **Change dosing direction :**

Here you can choose the dosing direction depending on the type of treatment and the type of product injected.

- **Maximum dosing time :**

This button is used to enter a maximum operating time of the pump over a period of 24 hours. This max time is configurable between 0 and 1440 minutes.

If the time of use of the pump exceeds this duration, in a period of 24 hours the dosing stops and it will resume only after the intervention of the user who will have to cancel this alarm.

At the end of 24 hours without exceeding the time, the latter is reset automatically



By setting 0 as the maximum dosing time, the time counting function is deactivated.

#### 4) Timings

Pressing the « Timings » button opens the programming window.

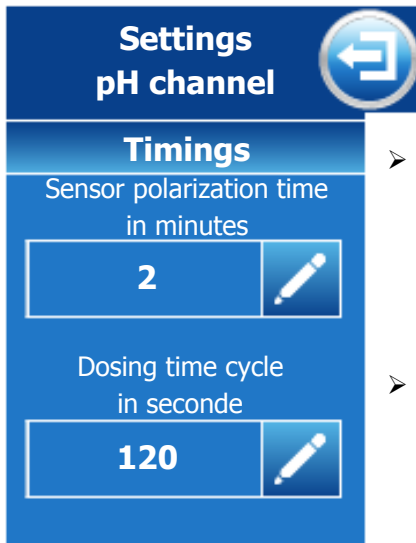

➤ **Sensor polarization time :**

This button is used to enter a sensor start delay between 0 and 480 minutes. During this time the alarms and dosing will not be active. This delay is activated when the regulator is turned on or when the flow detected by the Flow-Switch is restored if it is installed.

➤ **Temps de cycle du dosage :**

This button is used to set the cycle time of the dosing pump. This time is adjustable from 10 to 1800s. This time corresponds to the reaction time of the basin between the injection of product and the measurement of the product.



By setting 0 for the polarization time of the sensor, the function is deactivated and the sensor will be active immediately.

#### 5) Calibration



Calibrations are determining operations for good working of the controller and best treatment of the swimming pool!



A bad calibration could be dangerous for your health and your swimming pool. It can cause corrosions and destruction of the swimming pool parts. In any doubt about the procedure, contact our after sale service!



A bad setting point could cause excessive consumptions of calories and harm the environment!



Before carrying out the calibration of pH, Chlorine or Bromine measurements must be performed with special equipment using chemical reagents.



This operation does not require the stop the recirculating pumps nor the removing sensors from the measuring cell.



The chemical reagents for pH, Chlorine or Bromine measurements are not provided with the controller.



To proceed an automatic calibration:

- Recirculating circuit must work since several minutes
- Displayed value must be stable
- Dosing pumps must be stopped

Pressing the « Calibration » button opens the programming window.

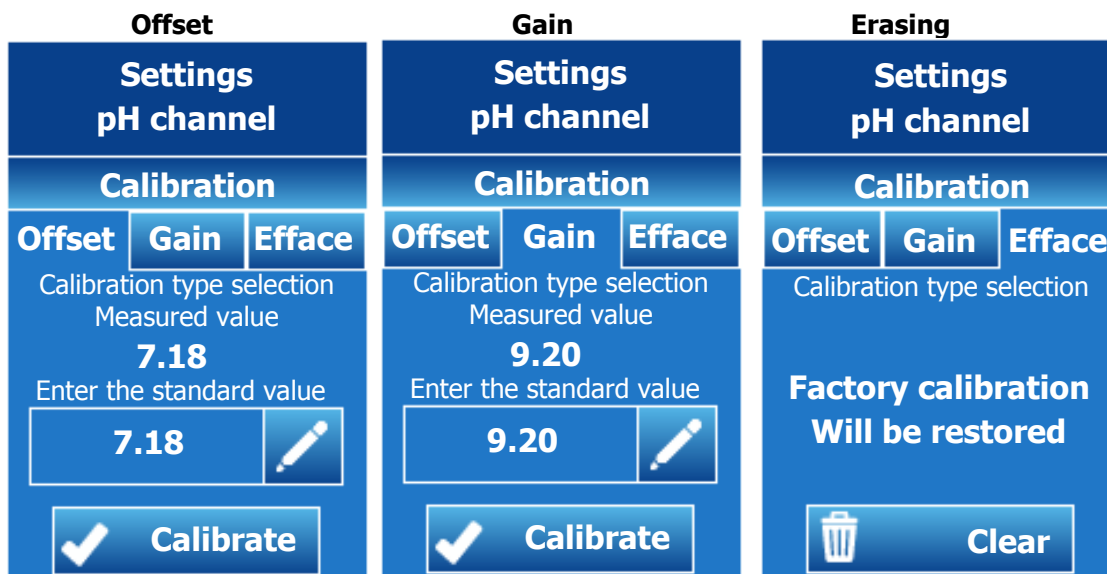

Calibration principle is identical for pH measurement or chlorine measurement.

- To calibrate the pH in 1 point on a photometer reading, use the **Offset** tab.
- If the calibration is done at pH7 we will use the **Offset** tab.
- If the calibration is done at pH4 or 9 we will use the **Gain** tab.
- To calibrate the chlorine in 1 point on a reading photometer we will use the **Gain** tab.
- Offset tab of chlorine is very rarely used unless requested by an experienced technician.
- To return to the "factory" version, use the **Clear** tab.

➤ Offset or pH7 calibration

**Offset** Select the Offset tab.



Press the key to open the input keyboard of the new near pH 7.

**Calibrate**

Press calibrate to validate the entry.

- In case of correct calibration "Calibration OK" is displayed in green
- In case of calibration error "Error Calibration" is displayed in red

➤ Gain or pH4 calibration

**Gain** Select the Gain tab.



Press the key to open the input keyboard of the new near pH 4.





Press calibrate to validate the entry.

- In case of correct calibration "Calibration OK" is displayed in green
- In case of calibration error "Error Calibration" is displayed in red

➤ Reset to factory calibration



Select the Erase tab.



Press Clear.

- "Calibration OK" information is displayed in green to confirm the deletion.



***Warning: this operation is irreversible. Once confirmed by the Clear key, your calibration parameters for this parameter will be lost.***

## IX. Maintenance

The device is maintenance free.

Repairs can only be carried out by qualified technicians and must be carried out in our SAUVAGNON factory.

For any problem on your device or for treatment advice, do not hesitate to contact our after sales services.







**SYCLOPE Electronique S.A.S.**

Z.I. Aéroport Pyrénées

64 230 SAUVAGNON

Tel : (33) 05 59 33 70 36

Fax : (33) 05 59 33 70 37

Email : [service-technique@syclope.fr](mailto:service-technique@syclope.fr)

© 2018 by SYCLOPE Electronique S.A.S.  
Subject to change.