



## **Installation and starting instructions**



Parts of the general documentation

- ▶ Part 1 : Installation and starting instructions
- Part 2 : Programming instructions
- Part 3 : Programming communication instructions

**General information:**

**SYCLOPE Electronique 2014**<sup>®</sup> Manual of the 07/05/2014 Rev 4

Professional Analyzers/Controllers for public swimming pools.  
**Product line EVASION**<sup>®</sup>

Part 1: Installation and starting instructions (Ref : DOC0171)

Editor :



**SYCLOPE Electronique S.A.S.**

Z.I. Aéropole pyrénées  
Rue du Bruscos  
64 230 SAUVAGNON - France –  
Tel : (33) 05 59 33 70 36  
Fax : (33) 05 59 33 70 37  
Email : [syclope@syclope.fr](mailto:syclope@syclope.fr)  
Internet : <http://www.syclope.fr>

© 2014 by SYCLOPE Electronique S.A.S.  
Subject to modification

I.	General informations .....	5
1)	Applicability .....	5
2)	FCC conformity .....	6
3)	Use of the document .....	7
4)	Symbols and signs.....	7
5)	Storage and transport.....	8
6)	Packaging .....	8
7)	Warranty .....	8
II.	Safety and environmental instructions.....	9
1)	Use of the equipment .....	9
2)	User obligations .....	9
3)	Risk prevention .....	9
4)	Labelling and localization of the identification plate .....	10
5)	Disposal and conformity.....	11
III.	Technical specification and functions .....	12
1)	Technical specifications.....	12
2)	Main functions.....	13
3)	Type and range of measurements .....	14
IV.	Installation and electrical connections .....	16
1)	Installation conditions.....	16
2)	Installation of the wall-mounted devices .....	16
3)	Electrical connections .....	16
4)	Primary electrical connections .....	17
5)	Connecting the power relay outputs free of potential.....	18
6)	Connecting the measurement inputs.....	18
7)	Connecting the power supply to the special measuring cells or converters .....	19
8)	Connecting the analogical outputs .....	20
9)	Connecting remote control inputs (CADx) .....	20
10)	Connecting the flow control inputs.....	20
11)	Connecting the I <sup>+</sup> I <sup>-</sup> bus.....	21
12)	Connecting the printer onto RS232 output .....	21
13)	Connecting the RS485 communication port.....	22
14)	Connecting the MODEM phone .....	23
15)	Connecting the internal GSM Modem .....	24
16)	Connecting an external GSM MODEM.....	24
17)	Connecting a WIFI socket modem .....	25
18)	Connecting an Ethernet socket modem .....	25
19)	Connecting the I2C communication port .....	26
20)	Infrared interface for remote control (IRC) .....	26
V.	General uses .....	27
1)	Sampling on gravity return line .....	27
2)	Sampling between pump and filtering group .....	28
VI.	Automatic configurations.....	29
1)	One circuit for .....	29
2)	Two separated filtration circuits.....	30
VII.	Introduction to the human-machine interface.....	31
1)	Display and control keypad .....	31
2)	Internal connections .....	32
3)	Connection terminal boards .....	32
VIII.	Starting the controller .....	33
1)	Setting an automatic configuration .....	33
2)	Programming the real time clock (RTC) .....	34
3)	Adjusting the contrast and the backlight intensity of the display .....	34
4)	Programming the setting points.....	35
5)	Programming technical alarms .....	36
6)	Direct calibration of measurement sensors.....	37
7)	Selecting and programming display modes.....	37
8)	Symbols and statutes of working .....	40

9)	Starting regulation and dosing. ....	41
IX.	Spare parts and accessories .....	42
X.	Maintenance.....	43
XI.	Appendices : Connections. ....	44

## I. General informations

### 1) Applicability

The analyzer/controller of the **SYCLOPE EVASION**<sup>®</sup> range you have just purchased is an electronic swimming-pool water management device. It has been carefully developed and manufactured to ensure your greatest pleasure and peace of mind.

Its remarkable capacity for adapting to different conditions and sizes of public swimming pools means it can be installed in the most difficult of environments where control of water treatment and swimming-pool water regulation processes are decisive.

Designed according to the needs of the customer, the **SYCLOPE EVASION**<sup>®</sup> controller is equipped with 10 analogical inputs, 2 numeric inputs and 2 pulse inputs for specific sensors for treating swimming-pool water and also include alarm functions and regulations with cyclic commands transmitted by means of six configurable internal relays and 2x8 external relays to control temperature, pH, ORP (mV), active, free, total chlorine, chloramines, active, free, total bromine for sea water and DBDMH / BCDMH bromines, cyanuric acid, Ozone, PHMB, Turbidity and conductivity levels. It can combine and calculate 8 parameters with these entries and use them as entire complete parameters.

Two ports, RS232 and RS485, for a printer and/or a computer link, allows communication by direct link or phone modem or GSM/WIFI/Ethernet Modems to a desktop computer (PC) for filing and graphic processing of the acquisition data.

**EVACOM**<sup>®</sup> and **SYSCOM**<sup>®</sup> software applications made by SYCLOPE Electronique S.A.S. have been developed to perform these functions.

The simplicity of operation of the **SYCLOPE EVASION**<sup>®</sup>, the user friendliness and the remarkable technical aspects of these controllers, will ensure you benefit from their many options, guaranteeing you full control and supervision of the quality of the water in your swimming pool.

The following instructions contain all the information required for the installation, use and maintenance of your new equipment.

- Installation
- Technical specifications
- Commissioning instructions
- Safety tips

If you would like to receive further information or if you encounter any difficulties not described in this manual, please contact your usual retailer or else directly contact the sales department of SYCLOPE Electronique S.A.S., either at the agency or at the office for your region, or the technical/quality departments of our establishments. We will do everything in our power to help you and ensure you benefit from our advice and know-how in the field of measurement and treatment of swimming-pool water.

Contact : [contact@syclope.fr](mailto:contact@syclope.fr)

## 2) FCC conformity

This device complies with Part 15 of the FCC rules. Operation is subject to the following two conditions: (1) This device may not cause harmful interference and (2) this device must accept any interference received including interference that may cause undesired operation.

Instructions to Users: This equipment complies with the requirements of FCC (Federal Communication Commission) equipment provided that the following conditions are met.



This equipment has been tested and found to comply with the limits for a Class B digital device, pursuant to Part 15 of the FCC Rules. These limits are designed to provide reasonable protection against harmful interference in a residential installation. This equipment generates, uses, and can radiate radio frequency energy and, if not installed and used in accordance with the instructions, may cause harmful interference to radio communications. However, there is no guarantee that interference will not occur in a particular installation.

If this equipment does cause harmful interference to radio or television reception, which can be determined by turning the equipment off and on, the user is encouraged to try to correct the interference by one or more of the following measures:

- Reorient or relocate receiving antenna,
- Increase the separation between the device and receiver,
- Connect the device into an outlet on a circuit different from that to which the receiver is connected,
- Consult the dealer or an experienced radio/TV technician for help.

Changes or modifications not expressly approved by the party responsible for compliance could void the user's authority to operate the equipment.

**Remark :** In order to maintain compliance with the limits of a Class B digital device, use a recommended shielded cable when connected to this device as describe in the present notice. Using a bad cable or a cable not connected to the ground voids the user's authority, which is granted by the Federal Communications Commission, to operate this equipment.

### 3) Use of the document

Please read carefully the entire document before starting the installation and the commissioning of the controller device, in order to ensure the safety of swimmers, users and equipments.

The information provided in this document must be strictly observed. SYCLOPE Electronique S.A.S. declines all responsibility in cases where failure to comply with the instructions of this documents.

The following symbols and pictograms will be used to facilitate reading and understanding of these instructions.

- Information
- ▶ Action to be taken
- Item of a list or catalogue

### 4) Symbols and signs



Identification of a continuous voltage or current.



Identification of an alternative voltage or current.



Protective ground.



Functional ground.



Risk of injury or accident. Identifies a warning concerning a potentially dangerous risk. The documentation must be consulted by the user with each time the symbol is notified. If the instructions are not respected, this presents risks of death, physical injuries or property damages.



Electric hazard. Identifies a warning statement relative to a mortal electric danger. If the instructions are not strictly respected, this implies an inevitable risk of physical injuries or death.



Risk of incorrect operation or damage for the device.



Comment or particular information.



Recyclable element.

### 5) Storage and transport



It is important to store and to transport the **SYCLOPE EVASION**<sup>®</sup> controller in its original packaging in order to minimize risk of damage. Furthermore, the package must be stored in an environment that is protected against humidity and exposure to chemical products.

Environmental conditions for transport and storage:

Temperature: -10 °C to 70 °C

Air humidity: Maximum of 90% with no condensation

### 6) Packaging



The controller is delivered without electrical power cable.

The pre-drilled holes of the box are drilled and equipped with according electrical glands in compliance with IP65 level protection. The cables must be adapted to the electrical glands for respecting the level of protection.

Content of the packaging:

- ✓ One analyser/controller **SYCLOPE EVASION**<sup>®</sup>
- ✓ Installation and starting instruction notice
- ✓ Programming notice
- ✓ Communication notice (Option)

### 7) Warranty

The warranty is provided according to the terms of our general conditions of sale and delivery as long as the following conditions are met:

- Use of the equipment according to the instructions of this notice
- No modifications of the equipment which may modify its behavior and no incorrect manipulation
- Respect for the electrical safety conditions



Consumable material is no longer covered by the warranty when in use.



## II. Safety and environmental instructions

Please:

- Read this manual carefully before the unpacking, the installing or the commissioning of this equipment
- Take into account all the hazards and of recommended precautionary measures

The failure to respect these procedures can result in serious injury to users or damaging the device.

### 1) Use of the equipment

The **SYCLOPE EVASION**<sup>®</sup> controller has been designed to measure and control temperature, pH, Redox potential, chlorine (or bromine), Ozone, PHMB, flow, Turbidity and Conductivity by means of sensors and controls of suitable actuators in the context of the possible uses described in this manual.



All other uses are considered to be non-conforming and must therefore be forbidden. SYCLOPE Electronique S.A.S. will not be responsible in any case for any damage that result from such uses.

### 2) User obligations

The user undertakes not to allow its employees to work with the **SYCLOPE EVASION**<sup>®</sup> controller described in this manual unless they:

- Are aware of the fundamental instructions relating to work safety and prevention of accidents.
- Are trained in the use of the device and its environment.
- Have read and understood these instructions, warnings and manipulation rules.

### 3) Risk prevention



The installation and connection of the **SYCLOPE EVASION**<sup>®</sup> controller should be only performed by a specialized personnel and qualified for this task.

The installation must comply with the current safety standards and instructions!



Before opening the controller or manipulate the relay outputs, always remember to switch-off the primary power supply!

Never open the controller when it is powered on!

Maintenance operations and repairs should be only performed by trained and specialized personnel!



Take care when choosing the location for installing the controller!

The controller should not be installed in a hazardous environment and should be protected against splashing with water or chemical products. It should be installed in a dry, well-ventilated and isolated location.



Make sure that the chemical sensors used with this controller correspond well to the chemicals used. Refer to the individual technical note of each sensor. Chemistry of water is very complex, in case of doubt, contact immediately our engineering service or your approved installer/reseller.



Chemical sensors are sensitive elements using consumable parts. They must be supervised, maintained and calibrated regularly using specific calibrator systems not-provided with this equipment. In the event of defect, a surplus possible hazard of chemical injections can be noted. In the doubt, a service contract must be taken near your reseller/installer or failing this near our engineering services. Contact your approved installer/reseller or our business service for more information.

4) Labelling and localization of the identification plate

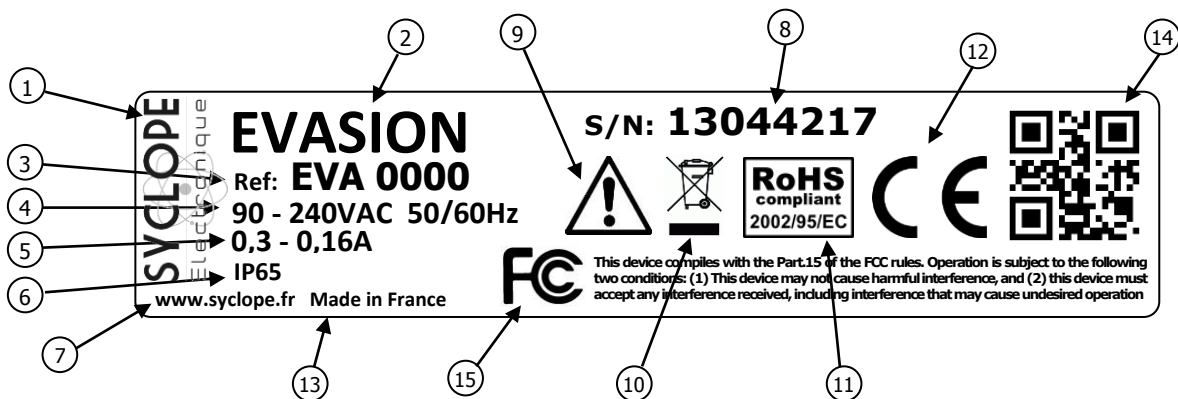

① Label of the manufacturer	⑨ Particular risks. Read the manual
② Model of the product	⑩ Product which can be recycled
③ Reference of the product	⑪ Limitation of dangerous substances
④ Range of power supply	⑫ EC compliance
⑤ Values of the maximum current	⑬ Country of the manufacturer
⑥ Class of protection	⑭ Manufacturer square code
⑦ Identification of the manufacturer	⑮ Conformity with the FCC part 15 Class B
⑧ Serial number	

Identification plate

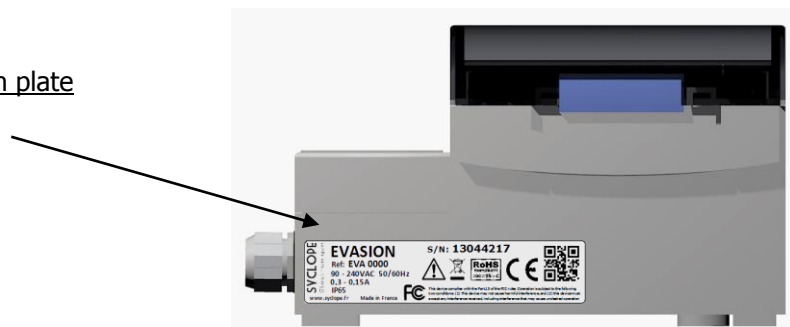

### 5) Disposal and conformity

The recyclable packaging of the **SYCLOPE EVASION**<sup>®</sup> equipment must be disposed of according to current regulations.



Elements such as paper, cardboard, plastic or any other recyclable elements must be taken to a suitable sorting center.



According to European directive 2002/96/EC, this symbol means that as of 12 August 2005 electrical appliances cannot be thrown out together with household or industrial waste. According to current regulations, consumers within the European Union are required, as of this date, to return their used devices to the manufacturer, who will take care of disposing them at no extra expense.



Collecting and recycling of the internal batteries: According to the European directive 2006/66/CE, this symbol indicate that until September, 26<sup>th</sup> 2006, used batteries, accumulators and waste materials using dangerous heavy metals as lead (pb), cadmium(Cd) or mercury (Hg) must be collected separately by the manufacturer or by an accredited agency.



According to European directive 2002/95/EC, this symbol means that the **SYCLOPE EVASION**<sup>®</sup> controller is designed in compliance with the restrictions on hazardous substances.



According to low-voltage directive (2006/95/EC) and the electromagnetic compatibility directive (2004/108/EC), this symbol means that the device has been designed in compliance with the previously cited directives.



In accordance with part 15 of the FCC regulation (Federal communications commission), this symbol indicates that the device was tested and approved under the respect and the conditions of the limits for a Class B digital device.

### III. Technical specification and functions

#### 1) Technical specifications

<b>General characteristics</b>		
Type	Specification(s)	Markers(s)
Consumption	0,3Amp. Max. (90VAC) to 0,15Amp. Max. (240VAC)	-
Power supply requirements	Between 90V to 240V +/-10%	-
Overvoltage Category	Category II	-
Temporary overvoltage	Accept temporary over voltages from power line.	-
Electric protection	Glass 5x20 time-lag 315 mA fuse	F5
Internal battery	Ni/MH battery pack 12V 600 to 1300mA/h Max.	-
Operating temperature (°C)	-5°C to 45°C	-
Storage temperature (°C)	-10°C to 60°C	-
Humidity	Max. 90% without condensation	-
Case material	ABS or Polycarbonate (UL/CSA Version)	-
Case dimensions	Length : 320 mm (12,6 Inches) Width : 260 mm (10,2 Inches) Height : 129 mm (5,1 Inches)	-
Weight of the case	3 kg	-
Protection rating	IP 65	-
Display	LCD 128x240 with blue backlight	-
<b>Inputs</b>		
Measurement inputs	10x powered analogue 4...20 mA inputs (12V)	E1 to E10
Control or flow inputs	2x programmable impulse inputs in « control On/off » or flow meter function.	CAD1 and CAD2
Numeric entries	2 numerical inputs for Cyanuric Acid sensor	E19 à E20
<b>Outputs</b>		
Relay outputs	6x relay outputs, contacts free of potential. Max. 5Amp. / 250 VAC	Relay1 to Relay6
Analogue outputs	6x Analogue outputs 0/4...20 mA Max 500 Ω	SA1 to SA6
Printer output	1 RS232 Printer port type	SV3
DC power outputs	2x 12VDC power supply outputs for powering electronic measurement cells. Max 1A together	12V
<b>Communications</b>		
RS485 Bus	1x RS485 communication port	RS485
I+I Bus	1x Serial communication port for external displays	I+I
I2C Bus	1x I2C serial communication port for external modules	LDA/LCL
Socket Modem (Optional)	1x Socket modem place for phone/WIFI/GSM/Ethernet	Phone line

2) Main functions

<b>Main functions</b>		
Function	Specification(s)	Comment(s)
Regulation mode	On/off, P, PI, PID, Auto configuration	Power outputs for treatment in % Relay cycle time for injection 240s.
Actuator type	Relay outputs - free of potential Analogue outputs 0/4...20mA or 20...0/4mA Impulse drive capability (With internal relays only)	Control with on/off with hysteresis or with cycle width modulation. (CWM) Control from 0 to 100% of programmed scale. Control with PWM from 0 à 120 cps/mn
Direction	Up and/or down function(s)	
Alarms	Low, high and technical alarms	Expressed in real measurement values Control of top and bottom thresholds.
Closed-loop control	Remote control Flow control Level control	Closed-loop control of injections with an external contact (filtering, for example) or with control of water circulation.
Timers	Programming of operating time intervals	Option of 4 different weekly time intervals.
Chemical computations	Chemical computation between selected entries.	8 computing
Configuration	Choice of standard configuration	Auto configuration with standard list
Maintenance	Maintenance helper	Control of dosing actuators
Recording	Data recorder	Data and event tracking
Extension modules	2 x 8 Relay modules 2 x 8 Analogue 0/4...20 mA modules	Driven by I2C bus.

3) Type and range of measurements

<b>Measurements and controls</b>		
<b>Parameters</b>	<b>Measurement ranges</b>	<b>Precision</b>
T°C	-5 to 45°C	± 0,5 %
	0 to 100°C	± 0,5 %
pH	0 to 14 pH	± 0,5 %
	-15,1 to 1 pH	± 0,5 %
Redox (ORP)	0 to 1000 mV	± 0,5 %
	0 to 1500 mV	± 0,5 %
Active chlorine	0 to 1 ppm	± 0,5 %
	0 to 2 ppm	± 0,5 %
	0 to 5 ppm	± 0,5 %
	0 to 10 ppm	± 0,5 %
	0 to 20 ppm	± 0,5 %
Free chlorine	0 to 1 ppm	± 0,5 %
	0 to 2 ppm	± 0,5 %
	0 to 5 ppm	± 0,5 %
	0 to 10 ppm	± 0,5 %
	0 to 20 ppm	± 0,5 %
Total chlorine	0 to 1 ppm	± 0,5 %
	0 to 2 ppm	± 0,5 %
	0 to 5 ppm	± 0,5 %
	0 to 10 ppm	± 0,5 %
	0 to 20 ppm	± 0,5 %
Active bromine	0 to 1 ppm	± 0,5 %
	0 to 2 ppm	± 0,5 %
	0 to 5 ppm	± 0,5 %
	0 to 10 ppm	± 0,5 %
	0 to 20 ppm	± 0,5 %
Free bromine	0 to 1 ppm	± 0,5 %
	0 to 2 ppm	± 0,5 %
	0 to 5 ppm	± 0,5 %
	0 to 10 ppm	± 0,5 %
	0 to 20 ppm	± 0,5 %
BCDMH	0 to 1 ppm	± 0,5 %
	0 to 2 ppm	± 0,5 %
	0 to 5 ppm	± 0,5 %
	0 to 10 ppm	± 0,5 %
	0 to 20 ppm	± 0,5 %
Ozone	0 to 1 ppm	± 0,5 %
	0 to 2 ppm	± 0,5 %
PHMB	0 to 20 ppm	± 0,5 %
	0 to 50 ppm	± 0,5 %
	0 to 100 ppm	± 0,5 %
Cyanuric acid	0 to 100 ppm	± 0,5 %
	0 to 300 ppm	± 0,5 %
Conductivity	0 to 1000 µS	± 0,5 %
	0 to 2000 µS	± 0,5 %
	0 to 5000 µS	± 0,5 %
	0 to 1 mS	± 0,5 %
	0 to 10 mS*	± 0,5 %
	0 to 50 mS*	± 0,5 %
	0 to 100 mS*	± 0,5 %

<b>Measurements and controls</b>		
Salinity	0 to 12 g/l	± 0,5 %
	0 to 32 g/l	± 0,5 %
	0 to 72 g/l	± 0,5 %
Turbidity	0 to 1 NTU	± 0,5 %
	0 to 2 NTU	± 0,5 %
	0 to 5 NTU	± 0,5 %
	0 to 10 NTU	± 0,5 %
	0 to 50 NTU	± 0,5 %
	0 to 100 NTU	± 0,5 %
	0 to 200 NTU	± 0,5 %
	0 to 500 NTU	± 0,5 %
	0 to 1000 NTU	± 0,5 %
Flow rate ratio	0 to 9999 liters/hour	
	0 to 999,9 m <sup>3</sup> /hour	

\* Option under development

## IV. Installation and electrical connections

### 1) Installation conditions



To guarantee the user safety and to ensure correct operation of the controller, please observe the following installation instructions:

- Install the controller in a dry location,
- The controller must be protected against rain, frost and direct sunlight,
- The room temperature must range between 0°C and 50°C, with no condensation,
- Choose an installation location free from vibration, on a suitable support and with no deformation.



If these instructions are not observed:

- The controller risks to be damaged,
- The measurements can be disrupted,
- The warranty is not applicable!

### 2) Installation of the wall-mounted devices



Before performing the installation and electrical connections, switch-off the power supply!

The rating of IP65 is only guaranteed when the cache of the electric part and the closure of the front face are closed and when the cable glands match to the diameters of the cables and are correctly sealed.

- ▶ Drill three  $\varnothing$  5-mm holes according to the following drilling plan

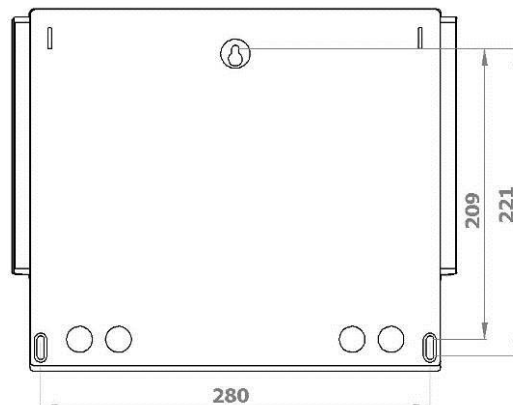

- ▶ Insert the 5-mm plugs using a hammer
- ▶ Insert the upper screw (top screw) first without completely tightening it
- ▶ Insert the lower screws and tighten them
- ▶ Tighten the upper screw
- ▶ Use a spirit level to check for correct and accurate fixing to the wall.

### 3) Electrical connections



The electrical installation must be performed in accordance with current rules by an authorized personnel!

A 30 mA differential circuit must be installed!

A circuit-breaker of maximum 10 Amp must be installed near the controller and easily accessible to stop the main power. It must be identified as a circuit-breaker for the controller!

Before performing the connections, remember to turn off the power!





Use core cables if possible!  
If not possible, always use a special wiring tip to be sure that the wires do not make a contact together!  
Protect the wirings by using electrical clamps.



The controller must be connected to the main recirculation pump by means of the "remote control" input (CAD) to disallow functionality in the case of the main pump being stopped.

#### a) Internal protection

The controller is protected by a 5x20 315mA time-lag glass fuse and by a varistor against voltage surges of 275 V.

Reference	Name
FUS5X20T315	5x20 315 mA time-lag glass fuse



In the event of the fuse blown, check that the card is not burnt out. If this is the case, the complete card must be changed!  
In the event of destruction of the varistor, please return the controller to our technical department for assessment!

#### b) Internal protection

The **SYCLOPE EVASION**<sup>®</sup> controller is equipped with Cd/Ni 12 Volts 700 mA/h (Old model) or Ni/MH 12 volts 1300 mA/h internal battery to assume the good working of the sensors during a short power down. The capacity of the battery and his recharge duration time determine the time of working under battery mode.

During power-on, an internal electronic power switch connects automatically the internal battery to the recharge circuit. This switch maintains the power supply as long as the battery is charged and switches-off the controller before complete discharge.



- The internal battery of the controller must be changed by an authorized technician. Contact your after-sell service or your reseller.
- Use only the recommended battery. In case of using another type of battery, the warranty will not be taken by SYCLOPE Electronique.
- Do not invert the wires when connecting!
- Do not use any external charger to recharge the battery.

Reference	Name
BAT1206	Battery 12V 0,6 A/h
BAT1213	Battery 12V 1300mAh Ni/MH with safety connector



The battery must be recycled according to the environmental rules!

#### 4) Primary electrical connections



The **SYCLOPE EVASION**<sup>®</sup> controller uses an internal switching power module. This particularity can be used with a power line of 90 to 250V 5/60Hz without any disturbance.

- ▶ Use a 3-points 1.5 mm<sup>2</sup> cable to wire the power supply. Ground cable must be connected firstly
- ▶ Strip the 3 wires for 7 mm.
- ▶ Pass the 3-point cable through a cable gland.
- ▶ Wire the live to 1 and the neutral to 2 of the sector terminal block B1.
- ▶ Wire the earth to screw contact with the help of an M4 eyelet terminal.
- ▶ Tighten the cable gland to ensure tightness.

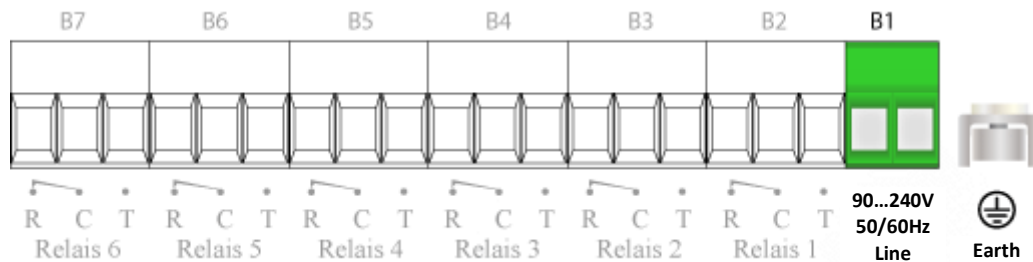

The controller does not have its own independent power switch. It is directly powered when connected to the mains.

#### 5) Connecting the power relay outputs free of potential

The power relay outputs, free of potential, are used to control the various measured or computed parameters. Relays OUT1 to OUT6 are fully programmable (On/off function, width modulation, pulse modulation or 3 points actuation) with all parameters using by the controller.

In case of use the automatic configuration, all power relays will be affected to a specific function (see table automatic configuration Chap VI.).

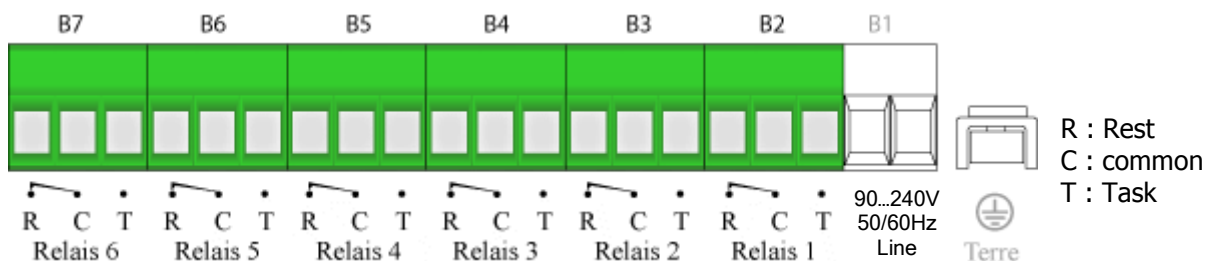

#### 6) Connecting the measurement inputs

The analogue inputs are used for acquiring multiple measurement sensors or special measuring cells using the 4...20mA loop technology.



The measurement entries of the controller are self-powered (12V) and must never be used with an external power supply!



The entries of the controller are not insulated between them!  
You must use unconditionally the appropriate special measuring cells or converters to be sure that each connected sensor works properly.  
Warranty repairs will not be accepted in the event of failing to observe these instructions!



Please, respect the polarities when connecting all the wires of the external measuring cells or of the converters onto the controller inputs. The external power supply (12V DC) needed is given by the controller on "+12V" outputs.

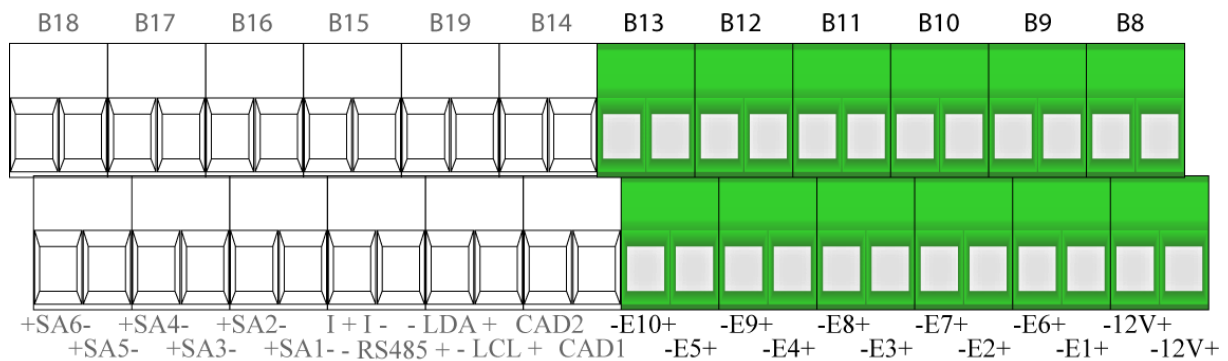

Special case when connecting a sensor with an active analog output (powered) :



- + of the active output (sensor) ⇔ - of the input (-Ex+)
- of the active output (sensor) ⇔ - of the power (-12V+)

Example beside with E6 input

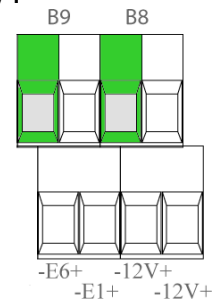

When using the automatic configuration option of the controller, all the corresponding inputs are defined according to the "Factory" setting. (See chap. VI : Automatic configuration of this manual)

7) Connecting the power supply to the special measuring cells or converters

To work properly, all special measuring cells or all special converters of SYCLOPE products must be powered by the +12VDC output generated by the controller.



Do not invert the power supply polarity!

- Red wire on the +
- Brown wire on the -

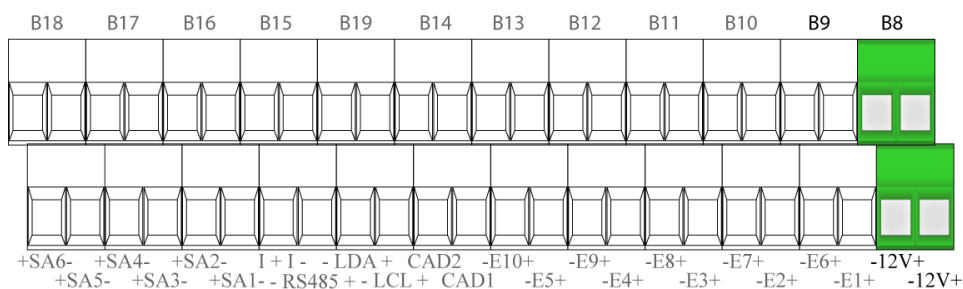

### 8) Connecting the analogical outputs

The analogue outputs of the controller are used to forward information to a central unit or to control a dosing unit by means of a signal of 0/4 - 20mA or 20...0/4mA.

The analogue outputs of the controller are fully configurable. Therefore, you can assign an output to any measured or calculated parameter and you can use it for control or transfer operations.

If you use the automatic configuration menu, all the analogical outputs will be defined according to the "Factory" setting. (See chap. VI : Automatic configuration of this manual).

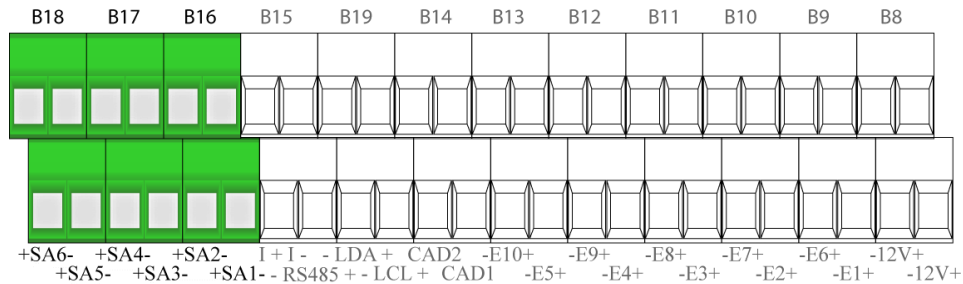

### 9) Connecting remote control inputs (CADx)

The **SYCLOPE EVASION**<sup>®</sup> controller has two remote control inputs (CAD1 and CAD2) which stops the dosing units. These inputs are either an open/closed contact input or a pulse control input used in a subservient manner to the main circulation pump of the filtration system.



It is imperative to enslave the controller to the switch of the filtering group's motor to prevent damages caused by chemical overdoses!



The remote control inputs CAD1 and CAD2 are designed to receive a NO contact (normally open), a NC (normally connected) or a pulse control drive (Open collector or free-potential switch).

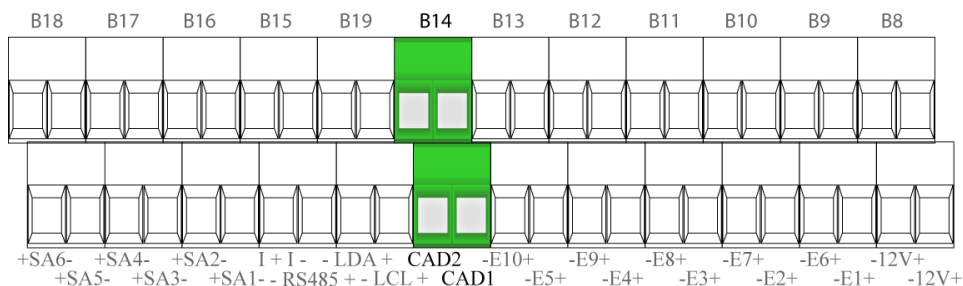

### 10) Connecting the flow control inputs

The **SYCLOPE EVASION**<sup>®</sup> controller has 2 fixed inputs (T°C and pH) and 8 programmable analogue inputs where each of them can be programmed as a flow control input (FCI) used to check the presence of circulating water in the measurement cells. This input is designed to receive either an analogue level sensor (4...20mA), either a flow switch control.

- Opened switch : Detection activated by open contact (Normally opened)
- Closed switch : Detection activated by closed contact (Normally closed)
- Analogue : Detection realized by 4-20 mA current loop.



The electronic flow-switches made by SYCLOPE Electronique S.A.S. are especially designed for universal measuring cells or for gravity measuring cells. These detectors are sold as optionals for all measuring cells. They must be ordered separately for the corresponding cell.

Reference	Name
DEB0000	Flow detector for universal measuring cells
DCC0000	Flow detector for gravity measuring cell 1" M (Kit)

11) Connecting the I+I bus

The **SYCLOPE EVASION**® controller has a serial communication bus named "I+I-" for viewing programmed parameters on special external displays. These displays are sold separately and can be used as a remote device of the selected parameters. The distance can be up to 500m. Eight remote displays can be used on the same bus with different address.

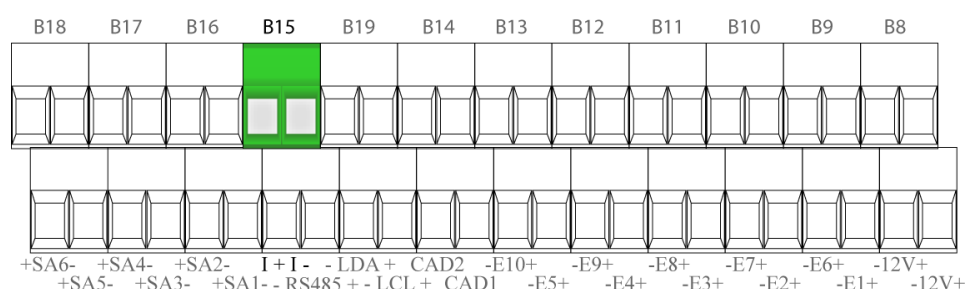

Please, take care to the polarity of each remote display.

- White wire on the I+
- Blue wire on the I-



Reference	Name
DEA0003	Remote display for Temperature, pH and chlorine
DEA0004	Remote display for Temperature, pH ad bromine
DEA0023	Remote display for pH, Chlorine1 and chlorine 2 (DUAL version)

12) Connecting the printer onto RS232 output

The controller has a serial-compatible RS232C output (speed: 4800 bauds) for printing paper reports, guaranteeing surveillance of your measurements and editing the operating log of the machine. To connect a printer to the RS232 port of the controller, you must order a compatible cable. The printer must be a standard printer with compatible ASCII code.

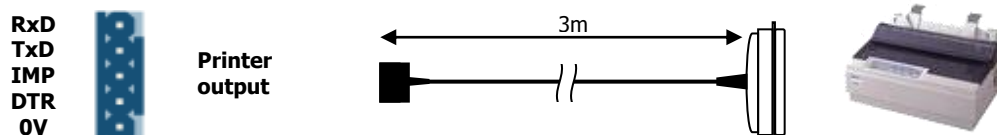

Reference	Name
IMP0080	Serial printer 80 caract.
CBI0000	Printer cable 5pts/DB25M Length 3m

13) Connecting the RS485 communication port

The **SYCLOPE EVASION**® controller has an RS485/RS422 communication port for linking a desktop computer equipped with the data-processing software **SYSCOM**® which trace measurements, alarms, instructions and display graphics or with the maintenance software **EVACOM**® which can program the controller in real time.

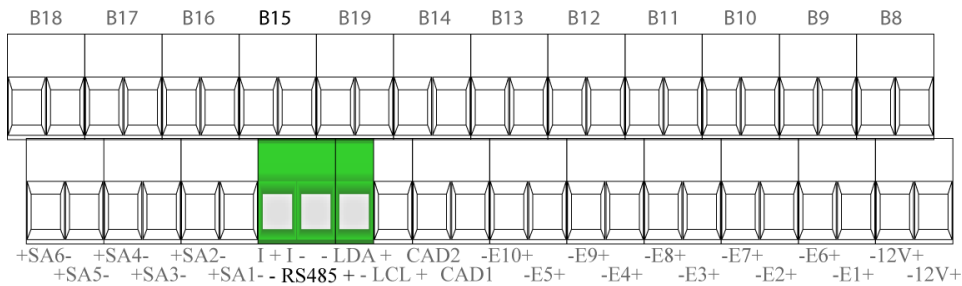

Please, contact us for further information on these products.



Respect the connection polarities of the bus.

- + of the terminal block on signal AA' (no. 3) of the USB/485 converter.
- - of the terminal block on signal BB' (no. 4) of the USB/485 converter.
- - (LCL) of the terminal block on GND (n°5) of the USB/RS485 converter.

a) Connection to USB port of the computer

We suggest using a USB/RS485 interface module to connect the **SYCLOPE EVASION**® controller to your computer. Please consult the instructions of this converter for the connection.

Reference	Name
INF1021	USB => 485 Converter

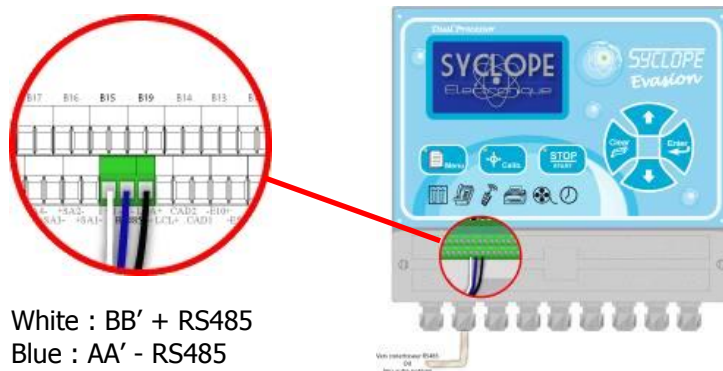

- White : BB' + RS485
- Blue : AA' - RS485
- Black : Ground -LCL



The controllers can be chained by respecting the order of the cables (putting in parallel).

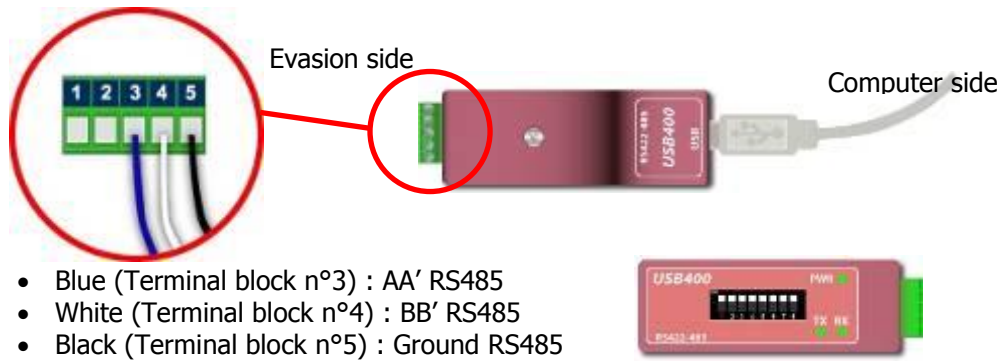

- Blue (Terminal block n°3) : AA' RS485
- White (Terminal block n°4) : BB' RS485
- Black (Terminal block n°5) : Ground RS485

Configuration : All switches are **"ON"**

a) Full connections with PLC using RS485 port

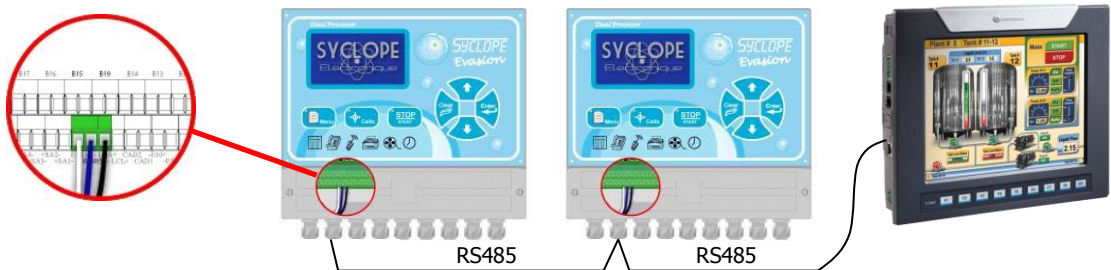

14) Connecting the MODEM phone

The controller has a Modem output for connecting to a phone line to establish a remote link with a computer via the **SYSCOM**® and **EVACOM**® communication softwares.

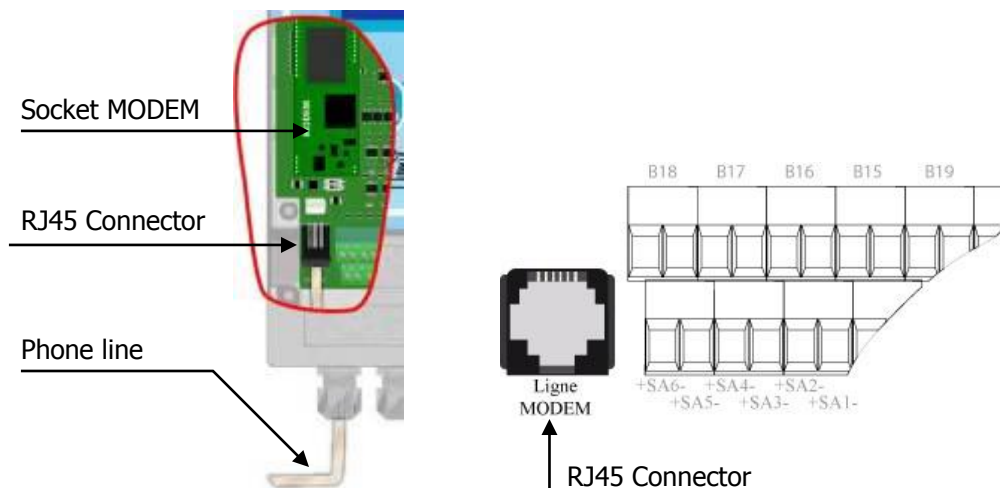

Reference	Name
KIM0000	Phone MODEM Socket kit for SYCLOPE controller (Modem, cable)

15) Connecting the internal GSM Modem

The controller has an internal location to connect the GSM socket Modem to establish a remote link with a computer via the **SYSCOM**® and **EVACOM**® communication softwares.

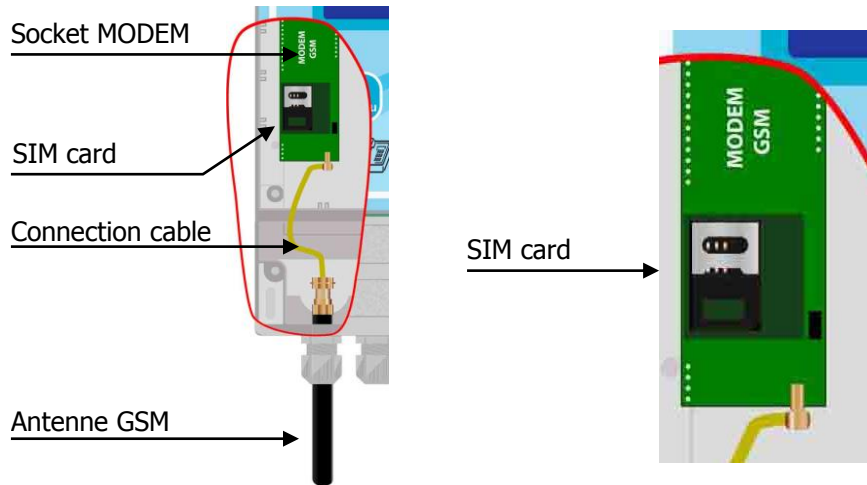

Reference	Name
KMD0020	Internal GSM Modem kit with cable and local antenna

16) Connecting an external GSM MODEM

The controller has an internal location to connect an adaptation plate allowing to pilot an external GSM Modem to establish a remote link with a computer via the **SYSCOM**® and **EVACOM**® communication softwares.

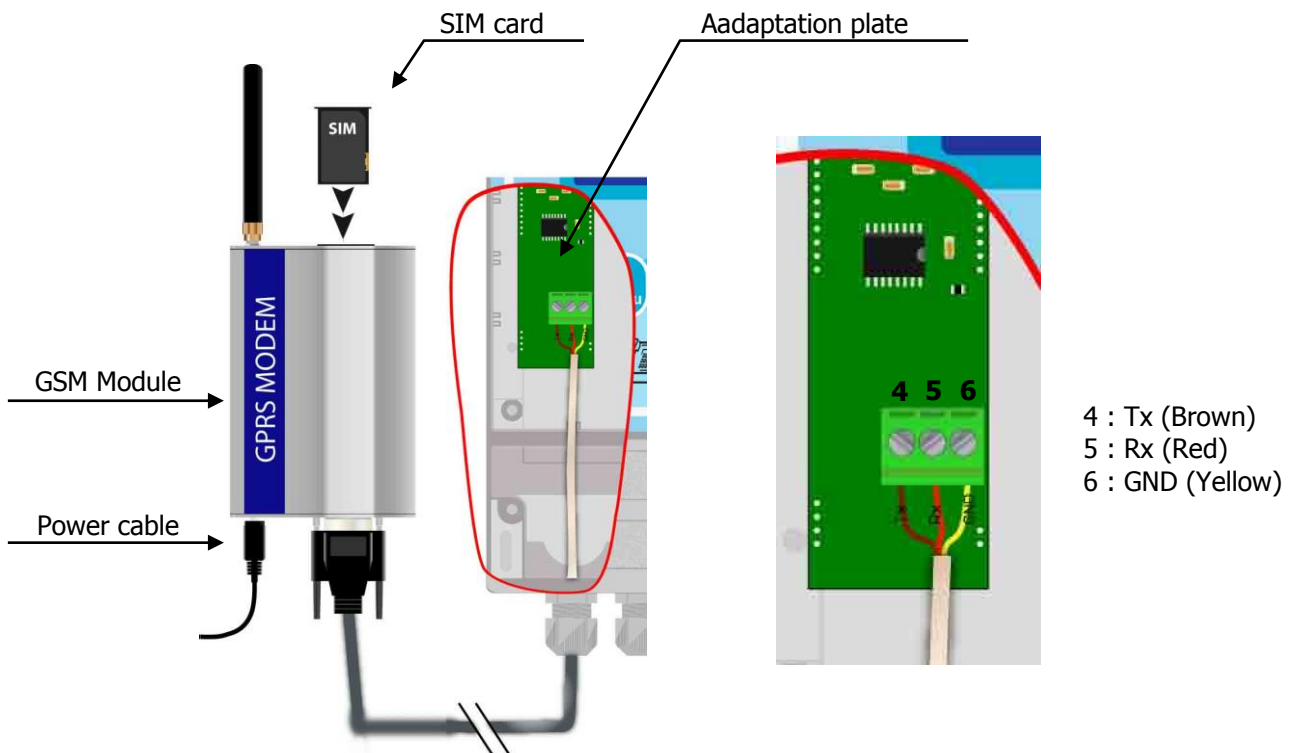

Reference	Name
KMD0030	External GSM Modem kit with cable and adaptation plate



17) Connecting a WIFI socket modem

The controller has an internal location to connect the WIFI socket Modem to establish a remote link to internet data web site **mysyclope.com** and through it, to a computer equipped of the **SYSCOM®** and **EVACOM®** communication softwares. (See manual 3 – Communications)

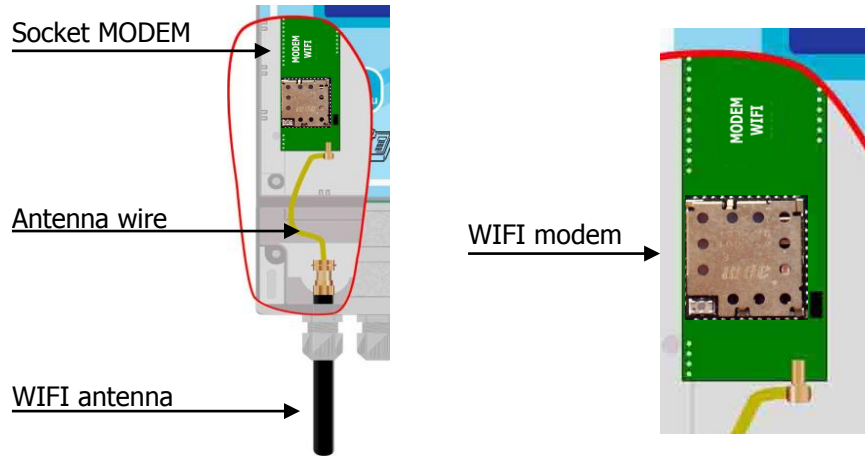

Reference	Name
KMD0050	Socket MODEM WIFI kit with cable and local antenna

18) Connecting an Ethernet socket modem

The controller has an internal location to connect an Ethernet socket Modem to establish a remote link to internet data web site **mysyclope.com** and through it, to a computer equipped of the **SYSCOM®** and **EVACOM®** communication softwares. (See manual 3 – Communications)

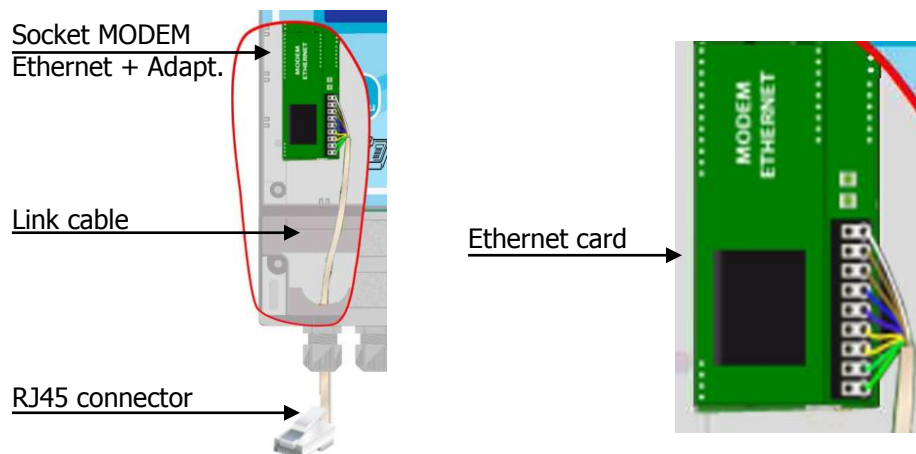

Reference	Name
KMD0040	Ethernet Socket MODEM kit with adaptation card

19) Connecting the I2C communication port

The controller has a compatible I2C output for connecting external extensions to establish a remote link with special modules using relays or 0/4...20mA. The internal software of the **SYCLOPE EVASION®** controller can drive up to 2 modules of 8 relays and 2 modules of 8 0/4...20mA analogue outputs.

a) Internal connections of I2C bus

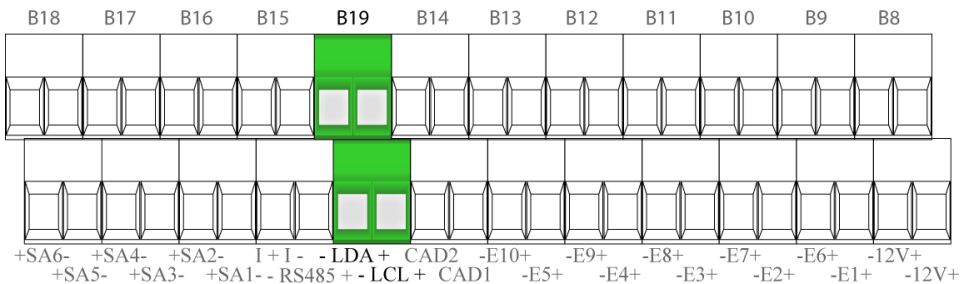

b) External connections of analogical and relays modules

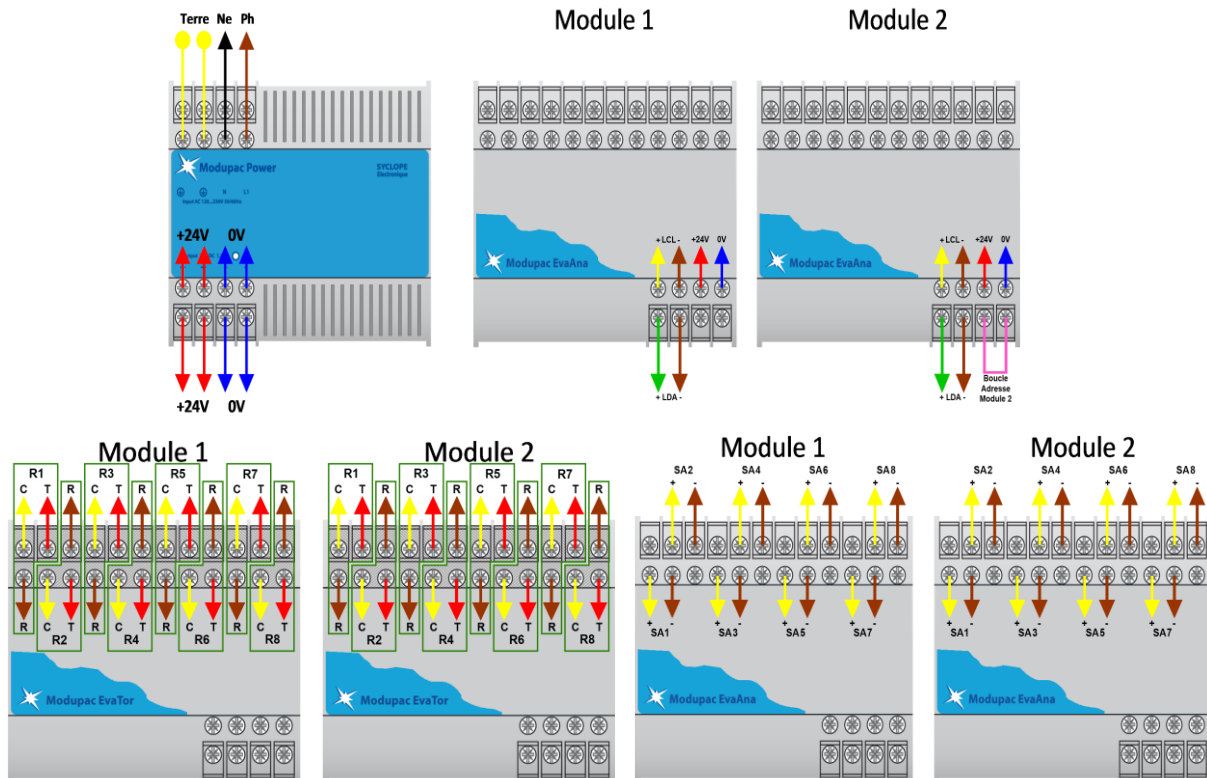

20) Infrared interface for remote control (IRC)

The controller has a compatible IRC communication port for infrared external remote control. This remote control equipment can drive the controller as the keypad on the front.

**Reference Name**

*Please, consult us for quotation.*

## V. General uses

The **SYCLOPE EVASION**<sup>®</sup> controller has been designed for measuring, regulating and treating the water in public swimming pools. The controller must be installed on the swimming-pool filtering circuits as shown in the two following diagrams

### 1) Sampling on gravity return line



This type of recirculating circuits is used when you have over one swimming pool with only one filtering group.

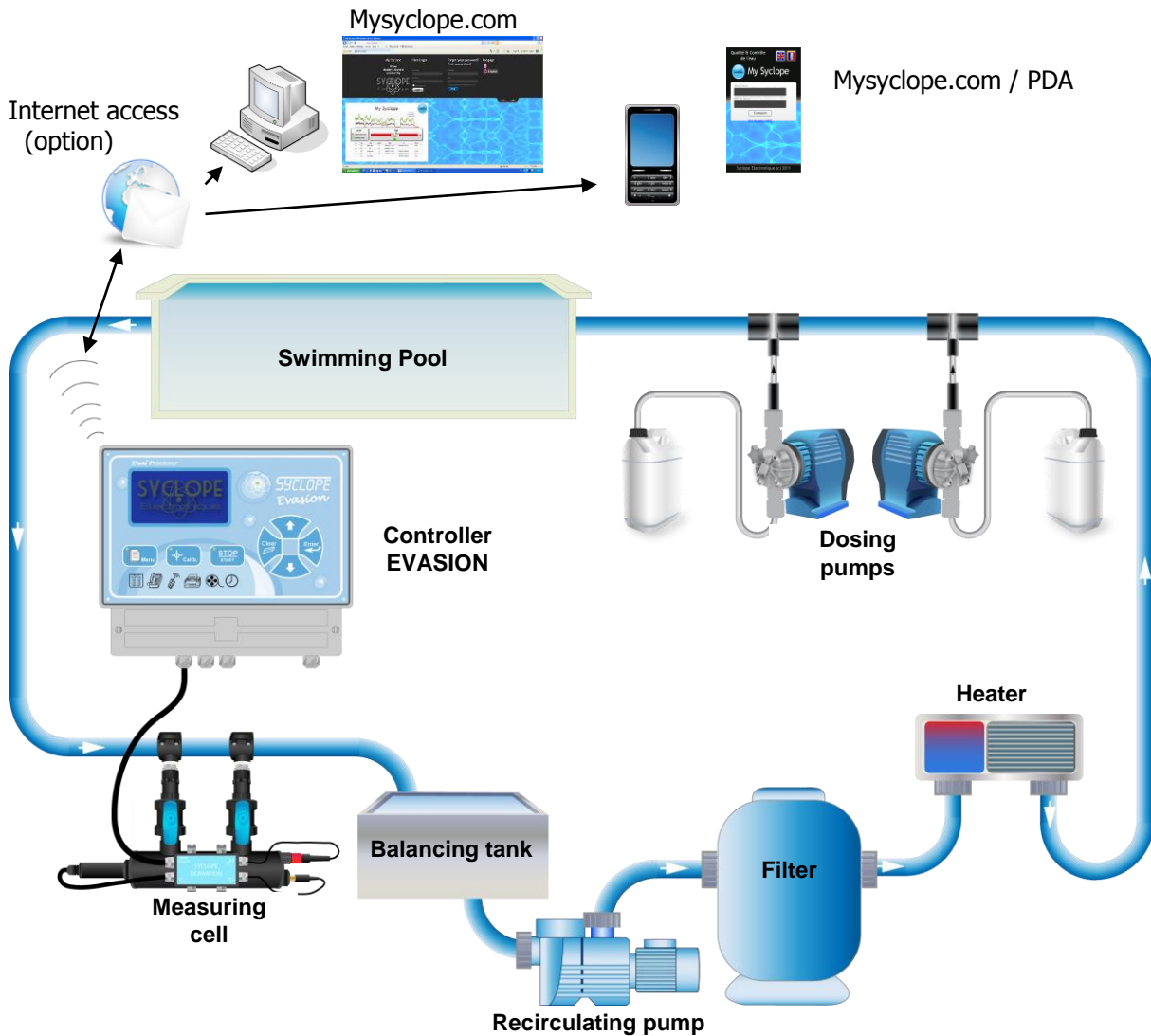

- The water to be measured, is sampled into the gravity measuring cell which is installed on the return line of the swimming pool.
- The measuring cell, equipped with the chemicals sensors, translates the informations into 0/4...20mA current loop signals to the controller.
- According the programmed setting points, the controller drives each dosing device according to the measured values.



Envisage a maximum distance between the injection points and the measuring point so that the injected chemical products are perfectly homogeneous!

2) Sampling between pump and filtering group

Generally, this type of recirculating circuit is recommended when only one filtering group is used or when each group is separated. However, you can use only one **SYCLOPE EVASION®** controller to control up to 8 filtering groups or circuits.

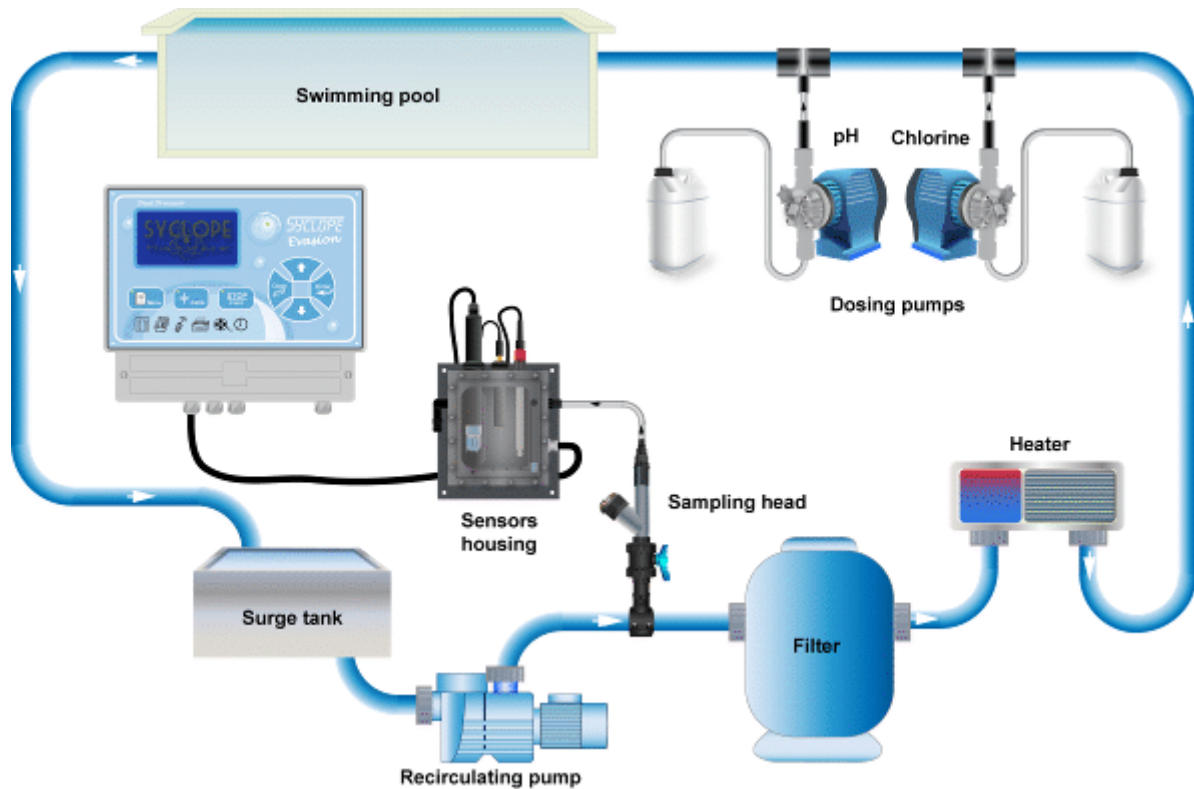

- The water to be measured, is sampled between the recirculating pump and the filter.
- The measuring cell, equipped with the chemicals sensors, translates the informations into 0/4...20mA current loop signals to the controller.
- According the programmed setting points, the controller drives each dosing device according to the measured values.

## VI. Automatic configurations

Although the **SYCLOPE EVASION**<sup>®</sup> programming is fairly simple and intuitive, we have integrated into the machine an automatic configurations menu that will give comfort during the commissioning and will save time.

You will find in the following tables, all configurations automatically preset as well as the assignment of the inputs and outputs and their wiring.

### 1) One circuit for

Type	Entries	Ranges	Wirings		Relays	Mode	Analogue outputs	CAD
			+	-				
<b>Ecopac2</b>	E1 : T°C E2 : pH E4 : Free chlorine	-5 à 45 0 à 14 0 à 10	White / Yellow Green White	White / Blue Blue Black	Relay1 : T°C Relay2 : pH Relay3 : Cl. libre	Control	NP	CAD1: NF
<b>Europeen</b>	E1 : T°C E2 : pH E3 : ORP E4 : Free chlorine	-5 à 45 0 à 14 0 à 1000 0 à 10	White / Yellow Green Yellow White	White / Blue Blue Orange Black	Relay1 : T°C Relay2 : pH  Relay3 : Free chorine	Control	NP	CAD1: NF
<b>Dual</b>	E1 : T°C E2 : pH E4 : Free chlorine 1 E6 : Free chlorine 2	-5 à 45 0 à 14 0 à 10 0 à 10	White / Yellow Green White White	White / Blue Blue Black Black	Relay1 : T°C Relay2 : pH Relay3 : Free chlorine Relay4 : Free chlorine	Control	NP	CAD1 : NF
<b>Combi</b>	E1 : T°C E2 : pH E4 : Active chlorine E6 : Total chlorine E11 : Free Cl. (CC) E12 : Combi. Cl (CC)	-5 à 45 0 à 14 0 à 10 0 à 10 0 à 10 0 à 10	White / Yellow Green White White - -	White / Blue Blue Black Black - -	Relay1 : T°C Relay2 : pH   Relay3 : Free chlorine Relay4 : Combi. Cl.	Control	NP	CAD1 : NF

\*NP : not programmed

\*\*CC : Chemical computing



**All measuring cells and converters are powered with 12V DC on B8 terminal (-12V+)**

**Coulor : (-) Brown (+) Red**

2) Two separated filtration circuits

Type	Entries	Ranges	Wirings		Relays	Mode	Analogue outputs	CAD
			+	-				
<b>Ecopac2 double</b>	E1 : T°C E2 : pH E4 : Free chlorine E6 : T°C E7 : pH E9 : Free chlorine	-5 à 45 0 à 14 0 à 10 -5 à 45 0 à 14 0 à 10	White / Yellow Green White White / Yellow Green White	White / Blue Blue Black White / Blue Blue Black	Relay1 : T°C Relay2 : pH Relay3 : Free chlorine Relay4 : T°C Relay5 : pH Relay6 : Free chlorine	Control	NP	CAD1: NF CAD2: NF
<b>European double</b>	E1 : T°C E2 : pH E3 : ORP E4 : Free chlorine E6 : T°C E7 : pH E8 : ORP E9 : Free chlorine	-5 à 45 0 à 14 0 à 1000 0 à 10 -5 à 45 0 à 14 0 à 1000 0 à 10	White / Yellow Green Yellow White White / Yellow Green Yellow White	White / Blue Blue Orange Black White / Blue Blue Orange Black	Relay1 : T°C Relay2 : pH  Relay3 : Free chlorine Relay4 : T°C Relay5 : pH  Relay6 : Free chlorine	Control	NP	CAD1: NF CAD2: NF
<b>Dual double</b>	E1 : T°C E2 : pH E3 : Free chlorine E4 : Free chlorine E6 : T°C E7 : pH E8 : Free chlorine E9 : Free chlorine	-5 à 45 0 à 14 0 à 10 0 à 10 -5 à 45 0 à 14 0 à 10 0 à 10	White / Yellow Green White White White / Yellow Green White White	White / Blue Blue Black Black White / Blue Blue Black Black	Relay1 : pH Relay2 : Free chlorine Relay3 : Free chlorine  Relay4 : pH Relay5 : Free chlorine Relay6 : Free chlorine	Control	NP	CAD1: NF CAD2: NF
<b>Combi double</b>	E1 : T°C E2 : pH E3 : Active chlorine E4 : Total chlorine E11 : Free chlorine (CC) E12 : Combi. Cl (CC) E6 : T°C E7 : pH E8 : Active chlorine E9 : Total chlorine E13 : Free chlorine (CC) E14 : Combi. Cl (CC)	-5 à 45 0 à 14 0 à 10 0 à 10 0 à 10 0 à 10 -5 à 45 0 à 14 0 à 10 0 à 10 0 à 10 0 à 10	White / Yellow Green White White - - White / Yellow Green White White - -	White / Blue Blue Black Black - - White / Blue Blue Black Black - -	Relay1 : pH    Relay2 : Free chlorine Relay3 : Combi. Cl  Relay4 : pH   Relay5 : Free chlorine Relay6 : Combi. Cl	Control	NP	CAD1: NF CAD2: NF

\*NP : non programmed

\*\*CC : Chemical computing



**All measuring cells and converters are powered with 12V DC on B8 terminal (-12V+)**

**Coulor : (-) Brown (+) Red**

## VII. Introduction to the human-machine interface

### 1) Display and control keypad

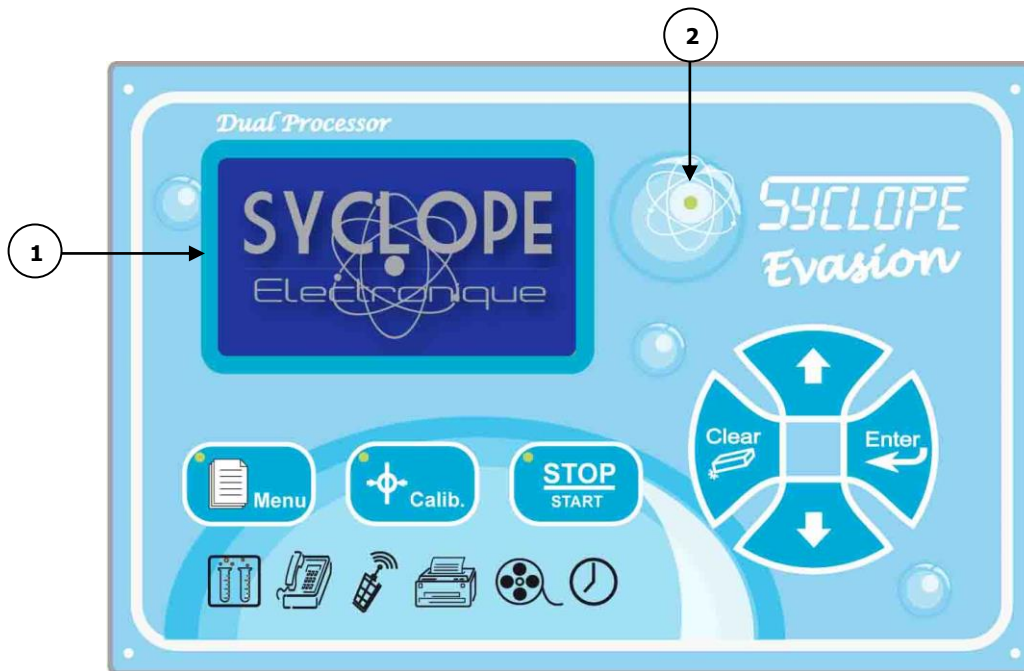

1 Backlight 240x128 display with white writing on blue backplane

2 Infrared receptor (IRC) for remote control unit



Menu button : provides access to the programming menu (yellow LED)



Calibration button: enables the sensors to be directly calibrated



STOP/START button: switches the regulators off (red LED)



STOP/START button: switches the regulators on (green LED)



Clear button: deletes the settings or moves back in the programming menus



Enter button: confirms the settings or moves forward in the programming menus



Up and down buttons: can be used to scroll through the menus and increase or reduce a value

2) Internal connections

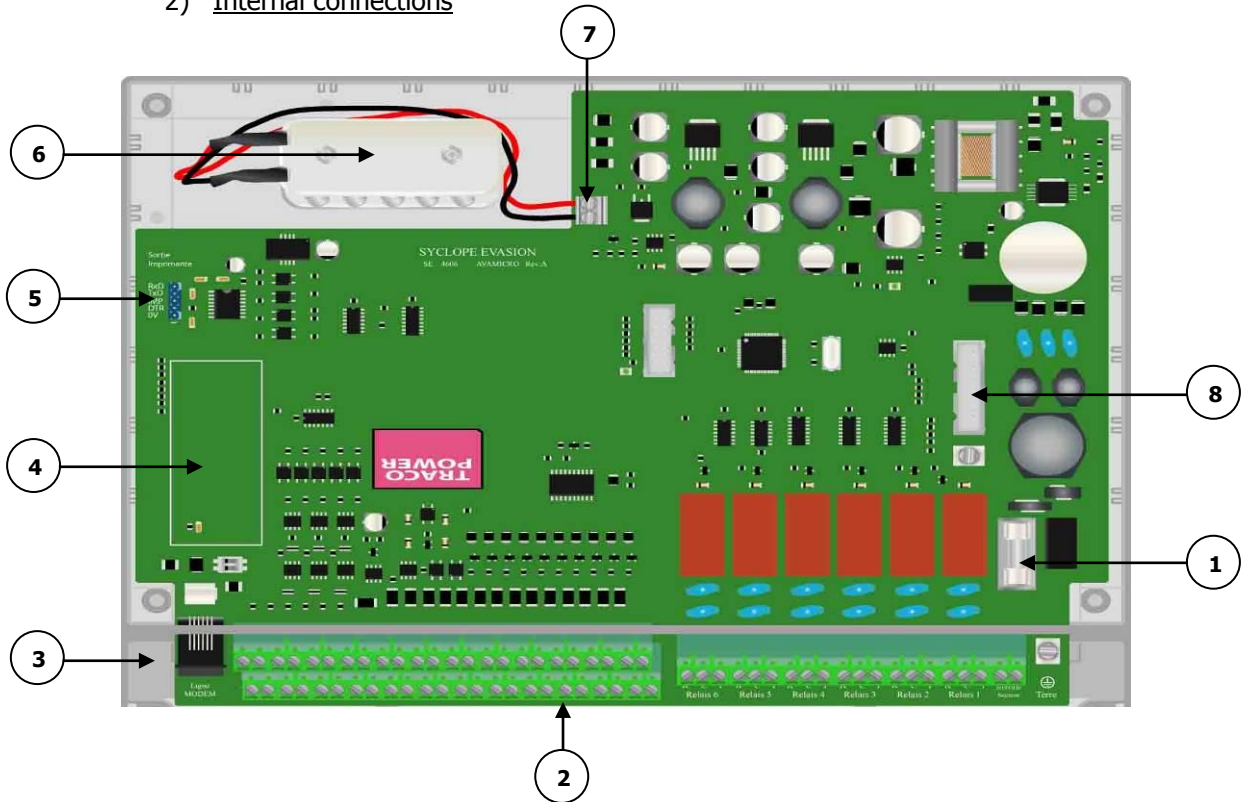

- 1 General protection fuse (glass 5x20 315 mA time-lag fuse)
- 2 Connection terminal blocks (see diagram at the bottom of the page)
- 3 Modem connector for phone line
- 4 Location for WIFI/GSM/Ethernet socket modem (optional)
- 5 Printer connector port
- 6 12V Battery
- 7 Terminal and wiring for the battery (+ : Red wire ; - : Black wire)

3) Connection terminal boards

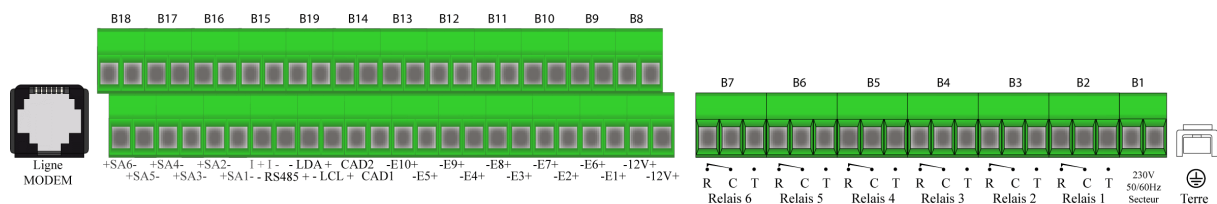



## VIII. Starting the controller

You have completed the electrical connections of the various sensors and actuators and are now ready to start the controller.



- ▶ Connecting the controller to the main power line
- ▶ Checking that all systems are correct, that your central unit has switched on and that the other elements of your installation are not disrupted.



The controller does not start automatically the controls of chemical products when powered. Only the user can control when to begin treatment having checked that the central unit has been correctly programmed according to his/her needs.

When the first power-on, the measured parameters predefined by the basic configuration are displayed and all processes are inactive.



When purchased alone, the controller is delivered in "ECOPAC2" configuration. This means you have to add some programming tasks according your needs.

### 1) Setting an automatic configuration

When you power-on the controller, a "**SYCLOPE LOGO**" screen appears, followed by the main screen displaying the measured parameters.

10H49 @	Page [↑Up ↓Down]
E01:Temp. =>	21.9 °C ><: 0.0 °C
E02:pH =>	7.49 pH ><: 0.00 pH
E03:Free Cl. =>	1.24 ppm ><: 0.00 ppm
E05:Total Cl =>	1.38 ppm ><: 0.00 ppm

- ▶ Follow the diagrams of instructions :



USER MENU
> Technician menu access
Select language
Setting real time clock
Interface management
Printing management



TECNICIAN MENU
> Specialist menu access
Technician code
Working timers
Sensors calibration
Setting points
Technical alarms
Analogue outputs



SPECIALIST MENU
> Specialist code
Analogue inputs definition
Chemical computations
Numerical inputs
Conditioned functions
Relays definition
Analogue outputs definition



SPECIALIST MENU
Numerical inputs
Conditioned functions
Relays definition
Analogue outputs definition
Displaying parameters
Communications
> Initializations

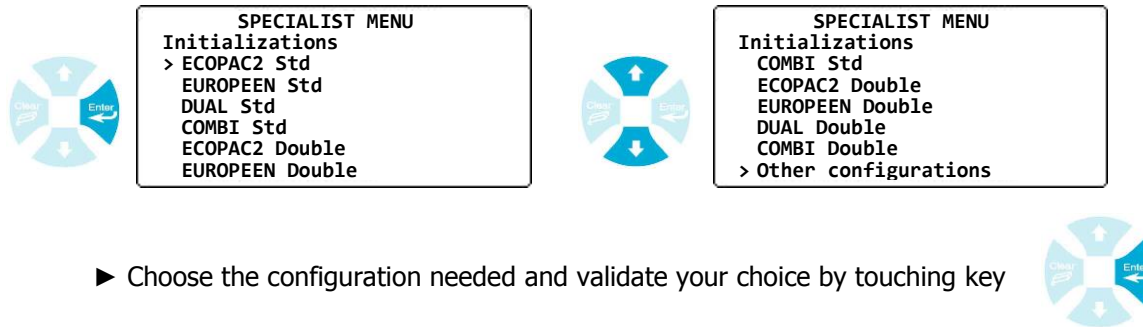

The controller initiates automatically the configuration you have selected and goes back to the main menu. The main menu is now automatically modified according to the configuration you have selected. (cf chapitre VI.)

## 2) Programming the real time clock (RTC)

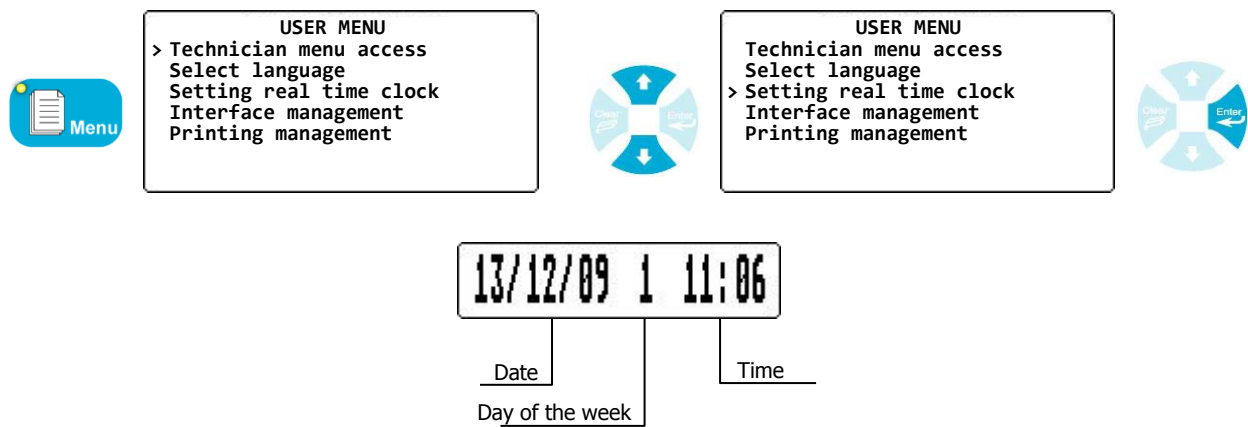

## 3) Adjusting the contrast and the backlight intensity of the display

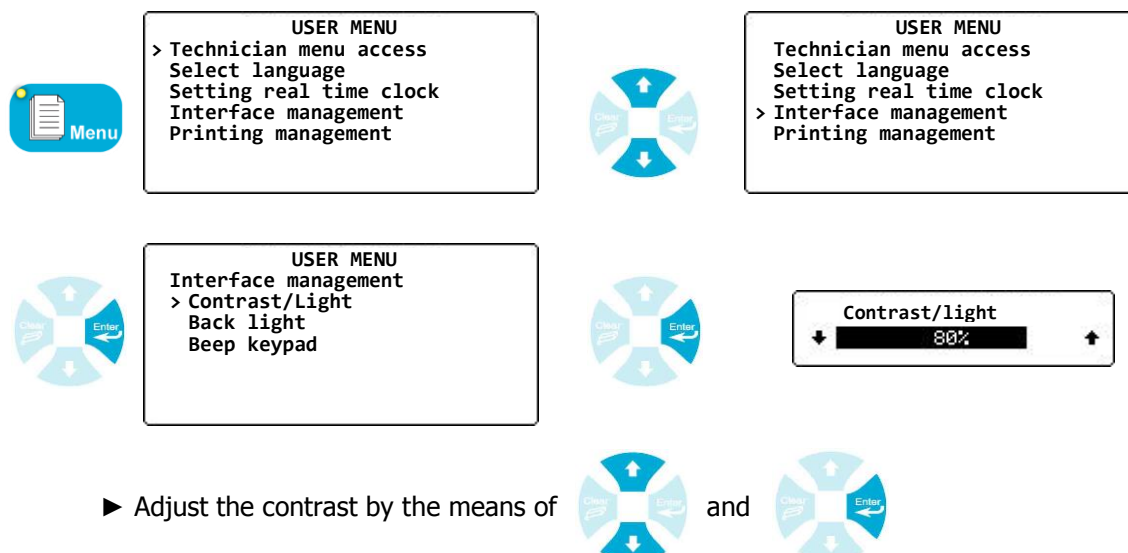

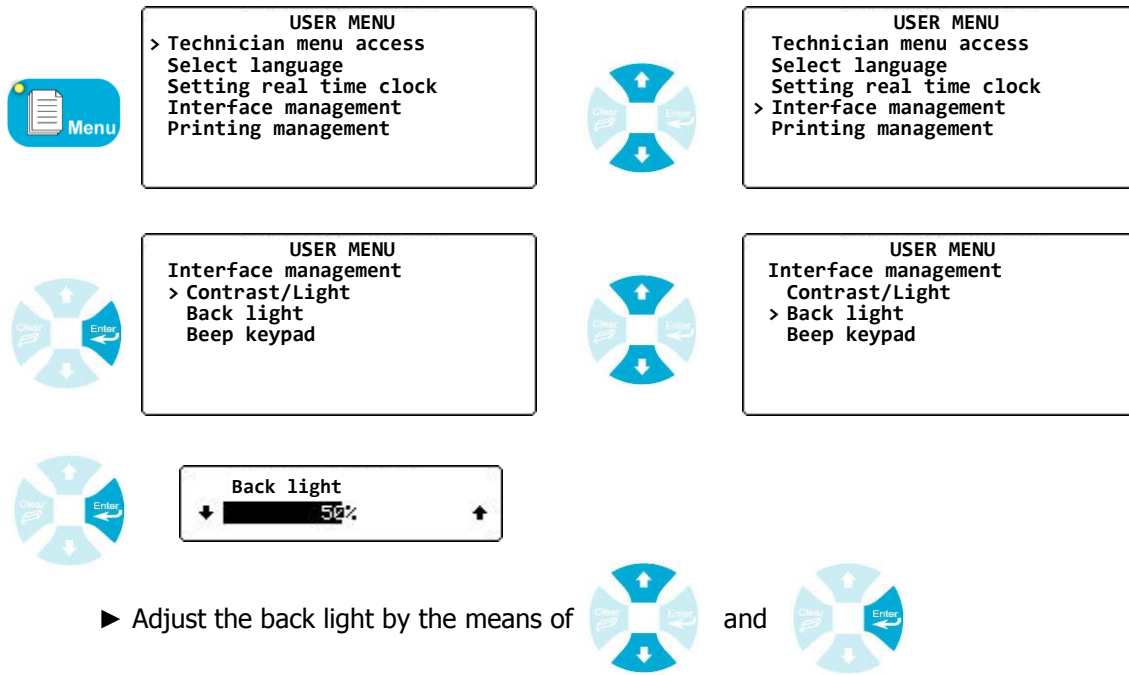

4) Programming the setting points



Entering incorrect setting points can have harmful effects on human health and the safety of the equipment of your swimming pool. In case of any doubt regarding the doses to use, contact our technical service department before programming it.



An incorrect setting point can result excessive doses of the chemical product, and thus harm for the environment.

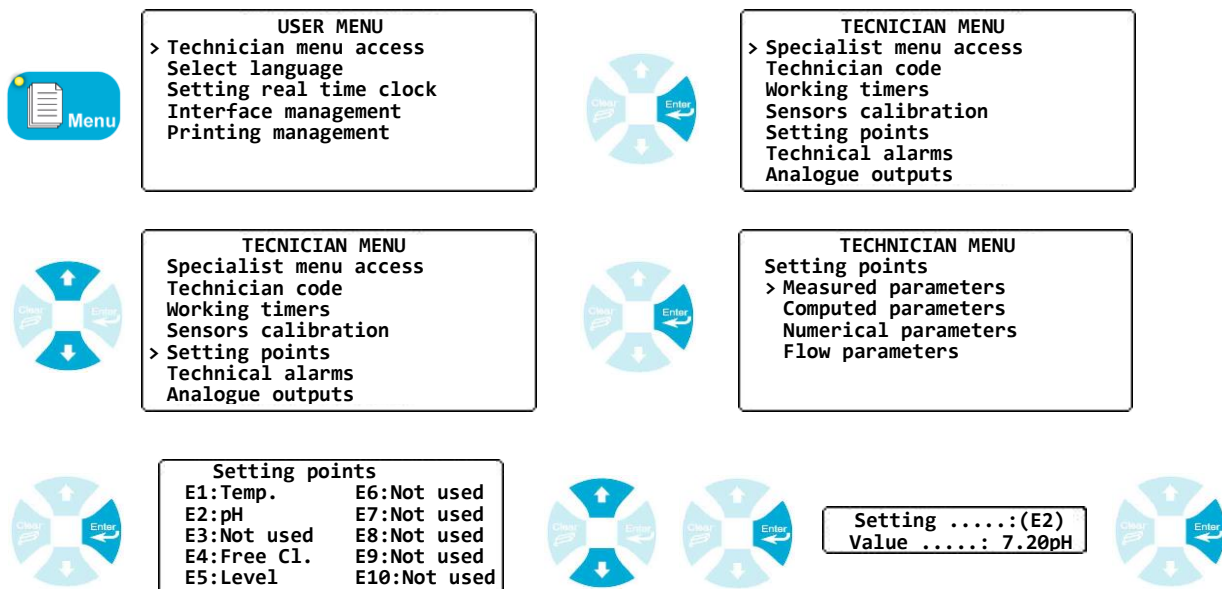

► Repeat this procedure for all other setting points...



Particular case for the setting points of flow measurements. In case of using flow meter, the setting point is a control compensated setting point. It is necessary to set the flow thresholds for 0 % and 100 % of the actuated control value.

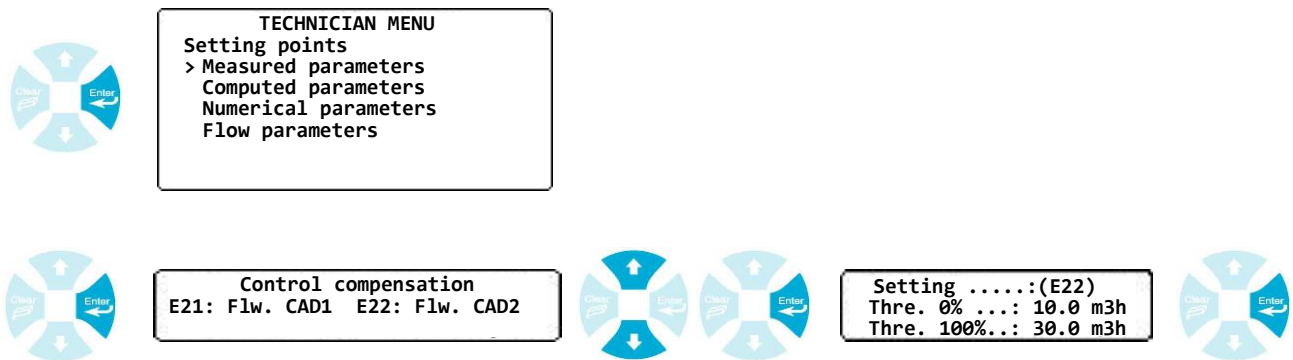

### 5) Programming technical alarms

Depending of the automatic configuration you have selected, the relays have been programmed with or without threshold action. To ensure the safety of the users and of the equipment, it is necessary to program the alarm thresholds to prevent excess or lowest product injections. These thresholds include a high level and a low level which you can modify according to the needs.

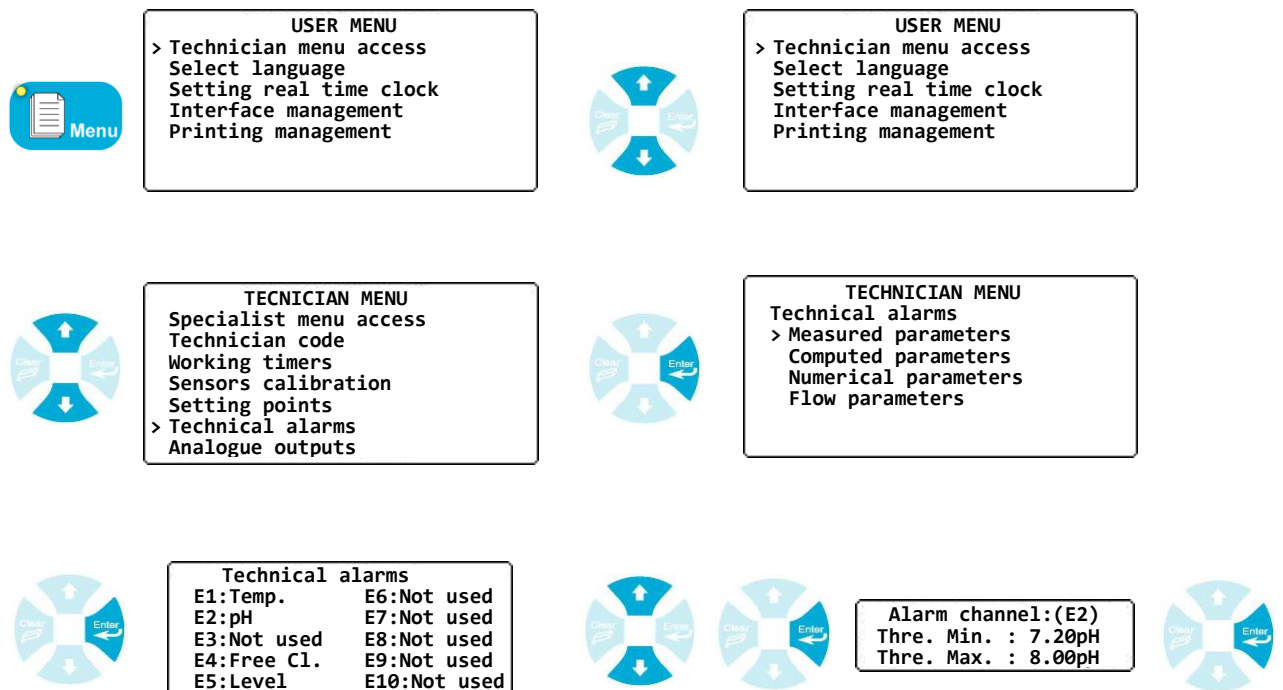

► Repeat the same procedure for all other used parameters.

6) Direct calibration of measurement sensors



Calibration of sensors is an essential element for the good treatment of your swimming pool. An incorrect calibration can be hazardous for human health and for the safety of the equipment of the swimming pool. In the event of any doubt concerning the operations to perform, please contact our technical department before calibration.



An incorrect calibration can result in excessive doses of the chemical product, and thus harm the environment.



The controller has a direct button on its front panel allowing you to perform a quick calibration.

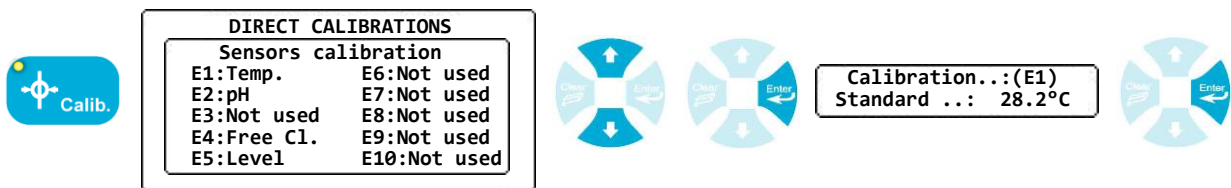

► Repeat the same procedure for all other used parameters.

7) Selecting and programming display modes

The **SYCLOPE EVASION**® controller offers any possibilities to display data according to your needs.

➤ **Display modes and types**

**Simple mode**

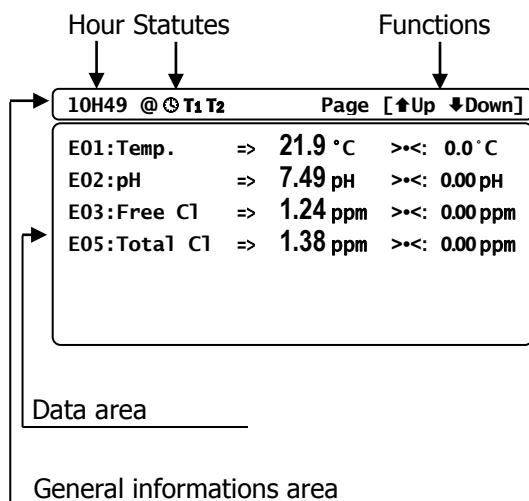

**Multi-pool mode**

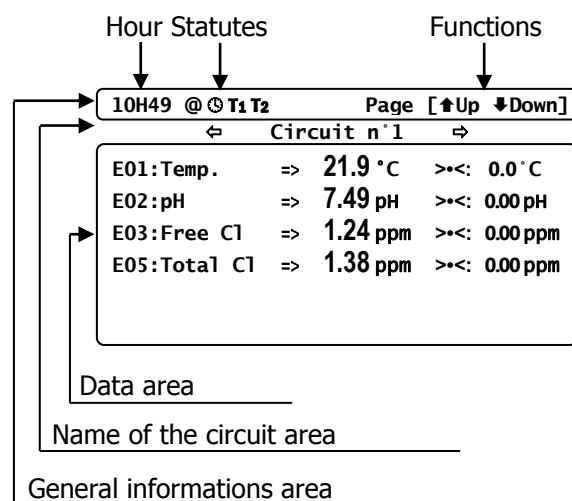

The two modes of display are available even according to your choice of type.

➤ **Horizontal type : Standard display**

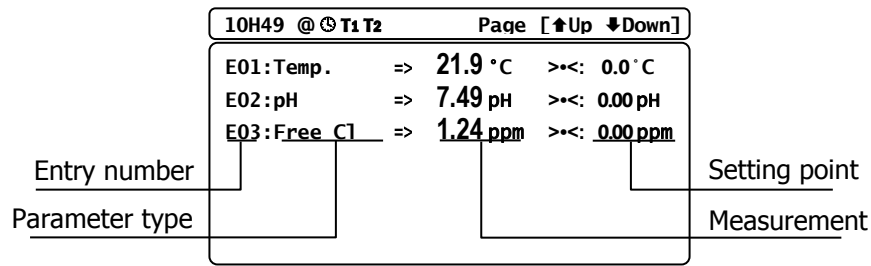

If you want to display more than 6 parameters in simple mode or 5 parameters in multi-pool mode, press on and on to scroll over more parameters.

➤ **Mosaic type**

To access at this mode, press on key from the "Horizontal" mode.

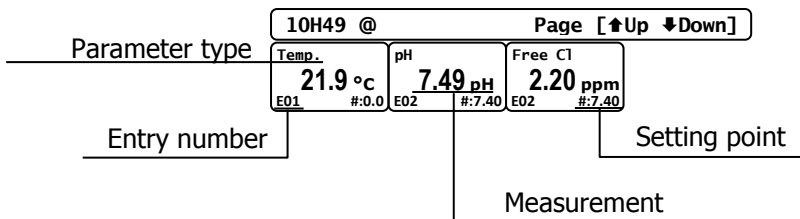

If you have more than 12 parameters, press on key and on keys to scroll over more parameters.

➤ **Vertical 3 parameters mode**

To access at this mode, press on key from the "Mosaic" mode.

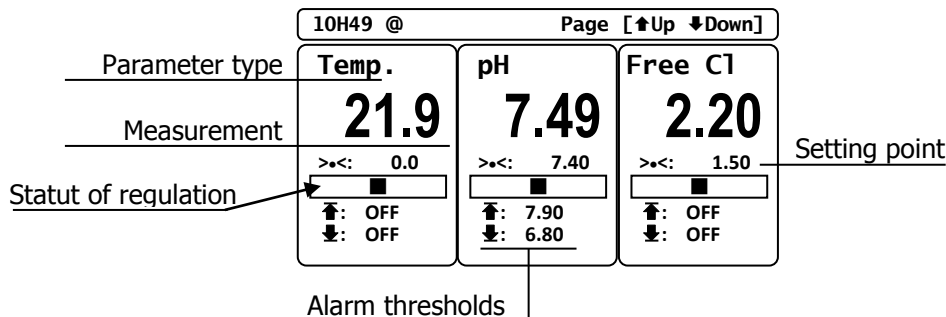



If you have more the 3 parameters programmed, press on key to validate the scrolling and press on keys to shift the display of the others parameters.

➤ **Vertical 4 parameters type**

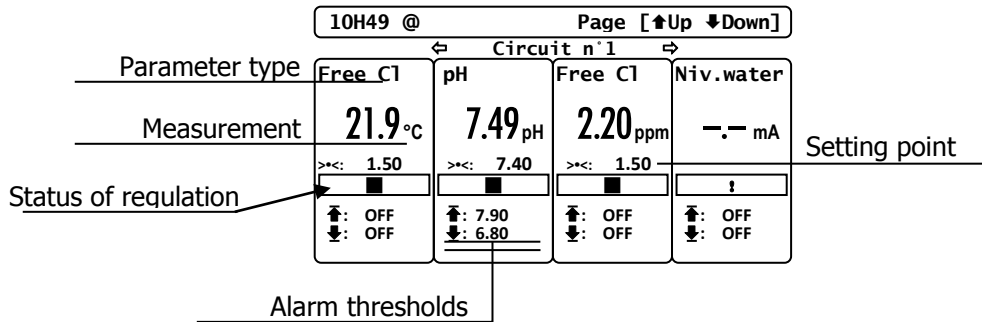
To access at this mode, press on  key from the "Vertical 3 parameters" mode.



 If you have more the 4 parameters programmed, press on  key to validate the scrolling and press on  keys to shift the display of the others parameters.

➤ **Displaying a graphic representation**

To access at this function, press on  key after selecting type.

Use the  keys to select the channel you want to see in graphic mode.

**From Horizontal type**

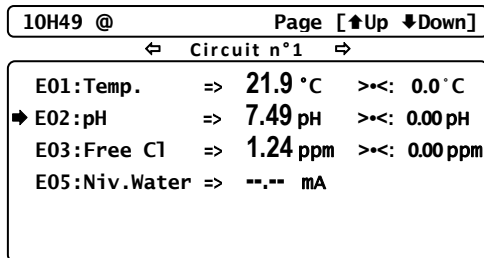

**From «Mosaic» type**

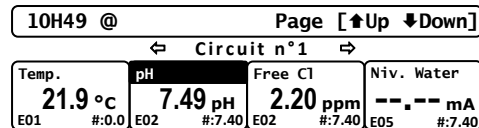

Press the  key to see the selected parameter.

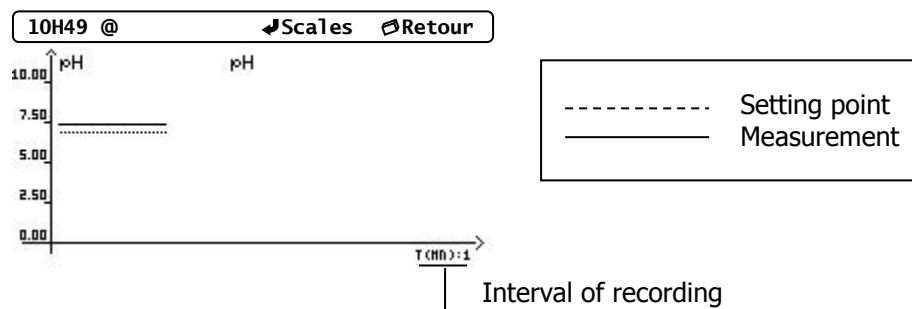

Press the  key to return to the normal selected numeric display.

Press again the



key in the numeric selected parameter mode to get out of the graphic mode.

## 8) Symbols and statuses of working

### ➤ **Icons of the statuses bar**

@ → Internet communication line activated.

⌚ → Active timer status. The controller is in « Pause » mode.

T1 → CAD 1 status. The selected conditioned parameters are in « Pause » mode.

T2 → CAD 2 status. The selected conditioned parameters are in « Pause » mode.

### ➤ **Statuses of an analogue parameter channel**

#### Measured value

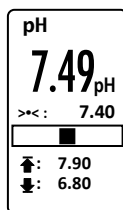

7.49<sub>pH</sub> → Measured real value

↑↑↑↑<sub>pH</sub> → Measured value over the displaying range

↓↓↓↓<sub>pH</sub> → Measured value under the displaying range

---<sub>pH</sub> → Measured value off (Technical alarm)

#### Control

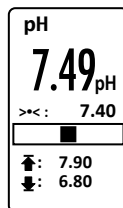

■ → Control stopped

☒ → Setting point not programmed

|| → Pause control mode for the parameter

0% → No treatment needs

42.8% → Active treatment with 42,8% of needs

! → No control. Parameter in alarm!

#### Alarms

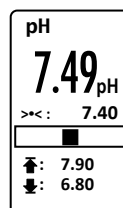

⌘: OFF → High threshold inactivated

⌘: 7.90 → High threshold programmed (Threshold = 7,9pH)

⌘: 7.90 ↑ → High threshold activated

⌘: OFF → Low threshold inactivated

⌘: 6.80 → Low threshold programmed (Threshold = 6,8pH)

⌘: 7.90 ↓ → Low threshold activated



➤ **Statutes of an analog level channel (Flow detection)**

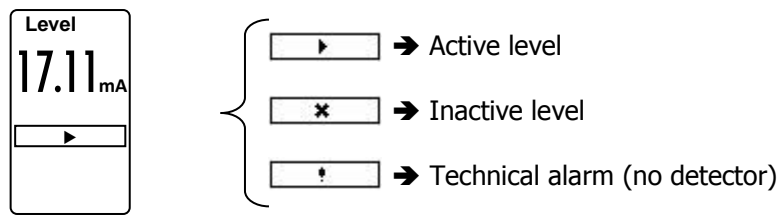

➤ **Statutes of a measuring flow channel**

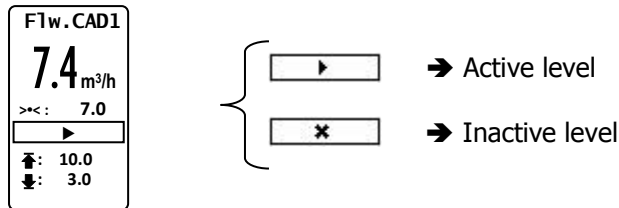

The two CAD inputs can be set in measuring flow channel. The “setting point” value is considered as the “On/Off” CAD threshold. The others channels conditioned to these CAD inputs will follow the Start/Break status regarding the flow level.

9) Starting regulation and dosing.

Once you have made entered all the preceding settings, you are ready to begin the controlling calculation and the dosing by means of the **SYCLOPE EVASION**<sup>®</sup> controller unit.





Before beginning processing, please make sure that all the parameters and various safety features mentioned in this documentation have been observed.

The LED in the  key lit in red color when the actuators are stopped.



When the user enters in the “Specialist menu”, the controller stops automatically. This to secure the system in case of changing control parameters. The user needs to restart the controller by pressing STOP/START key.

The LED in the  key lit in green color when the regulations are OK.

The green LED flash  when the timers are out-of the working limits during normal working time of the regulations.

▶ Press the  key to start the controller.

▶ Check everything works properly and that the central unit begins to works as required.

**IX. Spare parts and accessories**

<b>Reference</b>	<b>Name</b>
FUS5X20T315	Time lag fuse 315 mA 5x20
BAT1206	Battery 12V 0,6 A/h
EVAMICRO	Electronic card "EVAMICRO"
FAC0000	Complete front face SYCLOPE EVASION
ELC0115	Gland PG11 grey colour (Quantity 5)
CME2010	Universal housing without level detector T°, pH and Chlorine Isolated 10m of cable
CMI2010	Analogue convertor for T°, pH et Chlorine isolated 10m
CAC4210	PVC housing for gravity. 2T (Pg13,5 et 1/2") + 1T (1"M) Outputs 1" M
CME4010	Universal housing without level detector 4-20/4-20mA isolated (10m of cable)
CMI3010	Analogue converter 4-20mA (chlorine, dioxide,...) / 4-20mA isolated 10m
CAC4211	PVC gravity housing. 1T 1" Sortie 1" Male
CAA2506	Free chlorine sensor 0-10ppm
CAA2507	Active chlorine sensor 0-10ppm
CAA2503	pH electrode without pressure max 0.5bars
CAA2600	ORP electrode without reference max 6bars
CAA2513	Bromine BCDMH sensor 0-10 ppm
CAA2550	Ozone sensor 0-2ppm
CBI0963	Special housing for sea water and bromine measurement 0-10 ppm 10m
OPL1010	Cyanuric acid sensor OPTILIGHT 0-100ppm (Stabilizing)
OPL1020	PHMB sensor "OPTILIGHT" 0-100ppm
CAT2600	Temperature sensor 4...20mA -5°C à 45°C PVC 1/2"M
CAA2533	pH=7 solution in flats of 50 ml
ECH1046	Sampling system 1"M x 4/6PE with filter and valve
INF1021	USB RS485 converter
KIM0000	Socket MODEM kit Phone line SYCLOPE (Modem, cable and card)
KMD0020	MODEM GSM kit with cable and antenna
KMD0030	External MODEM GSM Kit with cables and external module

*Consult us for others references.*

## **X. Maintenance.**

The controller does not require any specific maintenance.

Repairs may only be performed only by qualified technicians, and must be carried out exclusively at our plant.

If you have any problems with the controller and/or chemical sensors or if you need treatment tips, do not hesitate to contact our after-sales department.

Email : [contact@syclope.fr](mailto:contact@syclope.fr)

**XI. Appendices : Connections.**

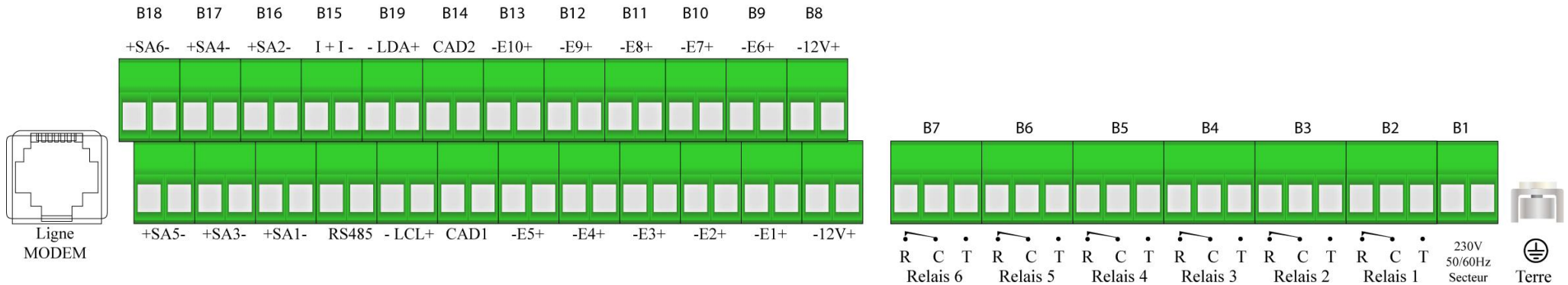

B8 (Over & under) → Supply power DC 12Volts (- +)

Inputs 4-20mA

- B9 (Under) → Inputs E1
- B9 (Over) → Inputs E6
- B10 (Under) → Inputs E2
- B10 (Over) → Inputs E7
- B11 (Under) → Inputs E3
- B11 (Over) → Inputs E8
- B12 (Under) → Inputs E4
- B12 (Over) → Inputs E9
- B13 (Under) → Inputs E5
- B13 (Over) → Inputs E10

Inputs CAD

- B14 (Under) → Inputs CAD1
- B14 (Over) → Inputs CAD2

Communication outputs

- B19 (Under) → Horloge Modules
- B19 (Over) → Data Modules
- B15 (Under) → Bus RS485
- B15 (Over) → Bus Afficheurs

Analogue outputs 4-20mA

- B16 (Under) → Output SA1
- B16 (Over) → Output SA2
- B17 (Under) → Output SA3
- B17 (Over) → Output SA4
- B18 (Under) → Output SA5
- B17 (Over) → Output SA6

B1 → Main power AC 230Volts + Ground

B2 → Relay outputs 1 (Rest - Common - Task)

B3 → Relay outputs 2 (Rest - Common - Task)

B4 → Relay outputs 3 (Rest - Common - Task)

B5 → Relay outputs 4 (Rest - Common - Task)

B6 → Relay outputs 5 (Rest - Common - Task)

B7 → Relay outputs 6 (Rest - Common - Task)

## EC Certificate of conformity

**Designation of the products: EVASION**

**Declaration :**

SYCLOPE Electronique SAS, Z.I. Aéroport Pyrénées in SAUVAGNON - France -, hereby certifies by the present that the following model "EVASION, controller for the analysis and controls of physicochemical measurements for swimming pool water" is in conformity with the standards and safety as defined by the European directives 2006/95/EC (Low voltage directive), 2004/108/EC (Electromagnetic compatibility) and 2002/95/CE (RoHS directive).

The present declaration is valid for all of the specimens manufactured after the date of this certificate and according to the original documents of manufacture.

The following standards were used for the examination:

- 2006/95/EC: EN61010-1 Ed.3:2010**  
2006/95/EC Low voltage directive,  
Safety requirements for electrical equipment for measurement, control, and laboratory use  
Including following deviations : IL, RU, US and CA  
Test report n° 385785-R2\_E of 2014, 10th September.
- 2004/108/EC: EN55022-(2006+A1:2007), EN55024(2010)  
EN61000-4-2, EN61000-4-3, EN61000-4-4, EN61000-4-5, EN61000-4-6, EN61000-4-8,  
EN61000-4-11, EN61000-3-2 and EN61000-3-3**  
2004/108/EC Electromagnetic compatibility (EMC Directive)  
Test report n° 385788-R1\_E of 2013, 2-21<sup>th</sup> April..  
**Harmonized standard ETSI EN 301 511 V9.0.2. GSM Communications**  
Test report n° 385788-R4\_E of 2013, 6-7<sup>th</sup> February.  
**Harmonised standard ETSI EN 300 328 V1.7.1. WIFI 5GHz band communications**  
Test report n° 385788-R4\_E of 2013, 6-7<sup>th</sup> February.  
**Harmonized standard EN62311(2008), EN50385(2002) and EN50383(2002)**  
Test report n° 385788-R4\_E of 2013, 21<sup>th</sup> May.
- 2002/95/EC: RoHS Directive (Limitation of dangerous substances).**

**Date of the first sale: 20014, February.**

The present declaration engages the responsibility of :



**SYCLOPE Electronique S.A.**  
**Z.I. Aéroport Pyrénées**  
**64 230 SAUVAGNON**

**Represented by :**

Georges BRETON  
President and General Manager

Sauvagnon : 2013/18/06









**SYCLOPE Electronique S.A.S.**

Z.I. Aéroport pyrénées  
Rue du Bruscos  
64 230 SAUVAGNON - France –  
Tel : +33 (0) 559 337 036  
Fax : +33 (0) 559 337 037  
Email : [contact@syclope.fr](mailto:contact@syclope.fr)  
Internet : <http://www.syclope.fr>

© 2014 by SYCLOPE Electronique S.A.S.