



## **Installation, commissioning, maintenance and programming instruction**

**SYCLOPE**  
Electronique

General information :

---

**HYDRO TOUCH®**

pH/ORP controller for private swimming pool with DULCOFLEX pumps

Operating and programming instructions of 07-10-2018

Reference : DOC0389

Publisher :

SYCLOPE Electronique S.A.S.

Z.I. Aéroport Pyrénées

Rue du Bruscos

64230 SAUVAGNON - France

Tel : +33 (0)5 59 33 70 36

Fax : +33 (0)5 59 33 70 37

Email : [syclope@syclope.fr](mailto:syclope@syclope.fr)

Internet : <http://www.syclope.fr>

© 2018 by SYCLOPE Electronique S.A.

Subject to change.

---

## SUMMARY

<b>1</b>	<b>General information .....</b>	<b>5</b>
1.1	Use of the document .....	6
1.2	Symbols and signs .....	6
1.3	Storage and transport .....	6
1.4	Packaging .....	7
1.5	Warranty.....	8
<b>2</b>	<b>Safety instructions .....</b>	<b>8</b>
2.1	Use of the equipment.....	8
2.2	User obligations.....	8
2.3	Risk prevention .....	9
2.4	Labelling and localization of the identification plate.....	9
2.5	Disposal and conformity .....	10
<b>3</b>	<b>Technical specifications .....</b>	<b>11</b>
3.1	General specifications HYDRO TOUCH devices.....	11
3.1.1	Technical specifications.....	11
3.1.2	Main functions .....	11
3.2	Installation of the wall mounted devices .....	12
<b>4</b>	<b>Installation and electrical connections.....</b>	<b>13</b>
4.1	Installation conditions .....	13
4.2	Wall installation conditions .....	13
4.3	Wall installation of control device.....	13
4.4	Installation of pipe saddles for sensors and products injection .....	14
4.4.1	Different situations may arise .....	14
4.4.2	Mounting procedure of pipe saddles.....	15
4.4.3	Mounting procedure for sensors connection kit .....	16
4.4.4	Mounting procedure for pipes connection kit.....	16
4.4.5	Mounting procedure for flexible sunction pipe .....	17
4.4.6	Mounting procedure of the pH sensor.....	18
4.4.7	Connecting the pH and ORP sensors on the HYDRO TOUCH device.....	18
4.5	Commissioning / Electrical connections .....	19
4.5.1	General connections.....	19
4.5.2	Changing the internal protection fuse.....	21
4.5.3	Specific connections .....	21
4.6	Filing the tanks of chemical .....	27
<b>5</b>	<b>HYDRO TOUCH controller presentation .....</b>	<b>28</b>
5.1	General operation .....	28
5.2	Human interface generality .....	29
5.3	Main display .....	30
5.4	User level settings .....	30
5.4.1	Headband settings .....	30
5.4.2	Set current date and time.....	31
5.4.3	Display details of a channel .....	32
5.4.4	Channel settings .....	33
5.4.5	Input screen for a numerical value .....	34
5.4.6	Programmation screen .....	34
5.4.7	Interface management .....	35
5.4.8	Brightness and contrast management.....	35
5.4.9	Screen protection managment.....	36
5.4.10	Colors managements.....	36
5.4.11	Change installer code .....	37
5.4.12	System information .....	37
5.5	Installer level settings .....	38
5.5.1	pH channel settings.....	39

---

5.5.2	ORP channel settings .....	42
5.5.3	Temperature channel settings.....	45
5.5.4	Timers settings .....	46
5.5.5	General settings.....	47
5.5.6	Communications settings.....	48
5.5.7	Advance settings.....	49
5.6	pH and ORP channel calibration.....	50
5.6.1	Automatic ph and ORP channel calibration (without reagents) .....	50
5.6.2	Manuel ph and ORP channel calibration (with reagents) .....	51
5.6.3	Calibration reset.....	53
5.7	Start of control and dosing .....	54
<b>6</b>	<b>Maintenance.....</b>	<b>54</b>
6.1	Maintenance of pH sensor .....	54
6.2	Maintenance of the dosing tubes of the metering pumps .....	55
<b>7</b>	<b>Wintering.....</b>	<b>56</b>
<b>8</b>	<b>Accessories .....</b>	<b>57</b>
<b>9</b>	<b>Failures and remedies .....</b>	<b>58</b>
<b>10</b>	<b>Maintenance .....</b>	<b>58</b>

---

## 1 General information

**HYDRO TOUCH** analysers/controllers you have purchased are a high-tech electronic devices. They were designed and created carefully for your enjoyment and your peace of action.

Their remarkable adaptability to different private swimming pools structures allows their installation in any harsh environments where control of water treatment is most critical.

With 2 pH and ORP input, a remote control one, a flow switch, a temperature input and two bottom tank detections, **HYDRO TOUCH** are endowed with proportional control functions with cyclic orders transmitted through two metering pumps to control the pH- or pH+ and ORP.

Thanks to **HYDRO TOUCH** ease of use, their user-friendliness and their remarkable technicality, you will fully enjoy their many possibilities and will be assured of a perfect control and perfect monitoring of your pool water quality.

You will find in the instructions that follow, all the information needed for the installation, use and maintenance of your new equipment.

- Packaging
- Installation
- Basic equipments
- Specifications
- Commissioning instructions
- Safety instructions

If you need more information or if you encounter problems that not have been specified in this guide, please quickly contact your retailer or SYCLOPE Electronique S.A. sales department, either at the agency or office in your area, or at technical/quality service at our head office. We will do our best to help you and make you enjoy our advice and our knowledge in the field of measurement and treatment of pools water.

### Head Office :

SYCLOPE Electronique S.A.  
Z.I. Aéroport Pyrénées  
Rue du Bruscos  
64230 SAUVAGNON - France  
Tel : +33 (0)5 59 33 70 36  
Fax : +33 (0)5 59 33 70 37  
Email : [service-technique@syclope.fr](mailto:service-technique@syclope.fr)  
Internet : <http://www.syclope.fr>

## 1.1 Use of the document

Please read carefully the entire document before starting the installation and the commissioning of the controller device, in order to ensure the safety of swimmers, users and equipment's.

The information provided in this document must be strictly observed. SYCLOPE Electronique S.A.S. declines all responsibility in cases where failure to comply with the instructions of this documents.

The following symbols and pictograms will be used to facilitate reading and understanding of these instructions.

## 1.2 Symbols and signs



Identification of a continuous voltage or current.



Identification of an alternative voltage or current.



Protective ground.



Functional ground.



Risk of injury or accident. Identifies a warning concerning a potentially dangerous risk. The documentation must be consulted by the user with each time the symbol is notified. If the instructions are not respected, this presents risks of death, physical injuries or property damages.



Electric hazard. Identifies a warning statement relative to a mortal electric danger. If the instructions are not strictly respected, this implies an inevitable risk of physical injuries or death.



Risk of incorrect operation or damage for the device.



Comment or particular information.



Recyclable element.

## 1.3 Storage and transport



It is important to store and to transport the **HYDRO TOUCH** controller in its original packaging in order to minimize risk of damage. Furthermore, the package must be stored in an environment that is protected against humidity and exposure to chemical products.

Environmental conditions for transport and storage:

Temperature: -10 °C to 60 °C

Air humidity: Maximum of 90% with no condensation

## 1.4 Packaging

The controller is delivered with:

- ✓ **HYDRO TOUCH** wall mounted electronic box
- ✓ pH and ORP sensors resistant to pressure (3 bars) with the possibility of installing at 90° compared with the vertical position.
- ✓ Hydraulic connections for pool pipe in  $\varnothing 50 - \frac{1}{2}$
- ✓ Injection kit
- ✓ Wall screws kit
- ✓ Hydro touch instruction manual
- ✓ Pompe doseuse intégrée de 0,4 ou 0,8 ou 1,6 ou 2,4 litres/heure.
- ✓ Tubings for pH pump
- ✓ Standard solution pH7



Codifications : Ensembles HYDRO TOUCH standards

Code Reference	HYDRO TOUCH pH Electronic box	Power supply	Measuring sensor	Metering devices	Protection class
<b>HYT0411</b>	Standard equipment $\varnothing 50$ with cable 1m 3x0,75mm <sup>2</sup>	230V 50/60Hz	pH and ORP with 6m of cable	Pumps 2x0,4l/h	IP54
<b>HYT0422</b>	Standard equipment $\varnothing 50$ with cable 1m 3x0,75mm <sup>2</sup>	230V 50/60Hz	pH and ORP with 6m of cable	Pumps 2x0,8l/h	IP54
<b>HYT0433</b>	Standard equipment $\varnothing 50$ with cable 1m 3x0,75mm <sup>2</sup>	230V 50/60Hz	pH and ORP with 6m of cable	Pumps 2x1,6l/h	IP54
<b>HYT0444</b>	Standard equipment $\varnothing 50$ with cable 1m 3x0,75mm <sup>2</sup>	230V 50/60Hz	pH and ORP with 6m of cable	Pumps 2x2,4l/h	IP54



**NOTE :**

*For equipment maintenance, spare parts are available in the « accessories » section.*

---

## 1.5 **Warranty**

The warranty is provided according to the terms of our general conditions of sale and delivery as long as the following conditions are met:

- ✓ Use of the equipment according to the instructions of this notice,
- ✓ No modifications of the equipment which may modify its behaviour and no incorrect manipulation,
- ✓ Respect for the electrical safety conditions.

**NOTE :**

*Consumable material is no longer covered by the warranty when in use.*

## 2 **Safety instructions**

Please:

- Read this manual carefully before the unpacking, the installing or the commissioning of this equipment
- Take into account all the hazards and of recommended precautionary measures

The failure to respect these procedures can result in serious injury to users or damaging the device.

### 2.1 **Use of the equipment**

The **HYDRO TOUCH** controller has been designed to measure and control pH and ORP by means of sensors and controls of suitable actuators in the context of the possible uses described in this manual.



All other uses are considered to be non-conforming and must therefore be forbidden. SYCLOPE Electronique S.A.S. will not be responsible in any case for any damage that result from such uses.



Any use of sensors or interfaces that do not comply with the technical specifications defined in this manual must also be prohibited.

### 2.2 **User obligations**

The user undertakes not to allow its employees to work with the **HYDRO TOUCH** controller described in this manual unless they:

- Are aware of the fundamental instructions relating to work safety and prevention of accidents.
- Are trained in the use of the device and its environment.
- Have read and understood these instructions, warnings and manipulation rules.



### 2.3 Risk prevention



The installation and connection of the **HYDRO TOUCH** controller should be only performed by specialized personnel and qualified for this task.  
The installation must comply with the current safety standards and instructions!



Before opening the controller or manipulate the relay outputs, always remember to switch-off the primary power supply!  
Never open the controller when it is powered on!  
Maintenance operations and repairs should be only performed by trained and specialized personnel!



Take care when choosing the location for installing the controller!  
The controller should not be installed in a hazardous environment and should be protected against splashing with water or chemical products. It should be installed in a dry, well-ventilated and isolated location.



Make sure that the chemical sensors used with this controller correspond well to the chemicals used. Refer to the individual technical note of each sensor. Chemistry of water is very complex, in case of doubt, contact immediately our engineering service or your approved installer/reseller.



Chemical sensors are sensitive elements using consumable parts. They must be supervised, maintained and calibrated regularly using specific calibrator systems not-provided with this equipment. In the event of defect, a surplus possible hazard of chemical injections can be noted. In the doubt, a service contract must be taken near your reseller/installer or failing this near our engineering services. Contact your approved installer/reseller or our business service for more information.

### 2.4 Labelling and localization of the identification plate

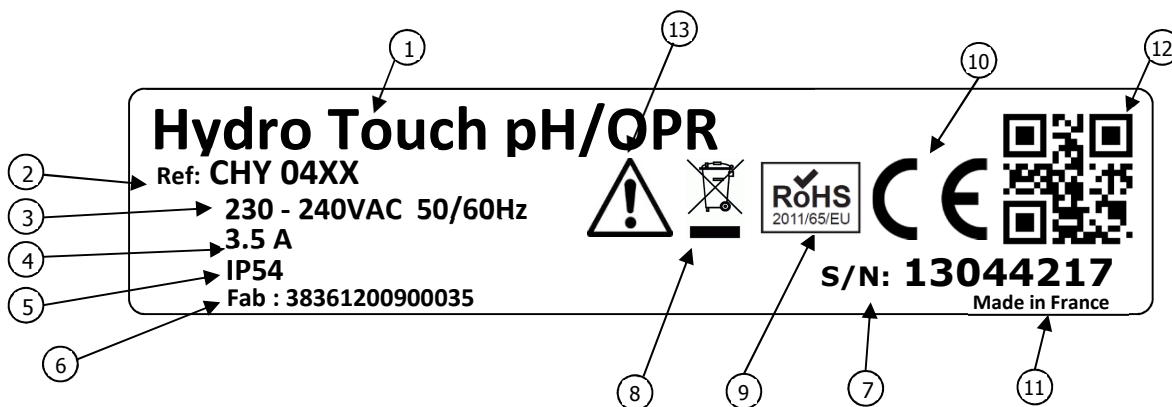

① Model of the product	⑧ Product wich can be recycled
② Reference of the product	⑨ Limitation of dangerous substance
③ Range of power supply	⑩ EC compliance
④ Values of maximum current	⑪ Country of manufacturer
⑤ Class of protection	⑫ Manufacturer square code
⑥ Identification of the manufacturer	⑬ Particular risks. Read the manual
⑦ Serial number	

---

## 2.5 **Disposal and conformity**

The recyclable packaging of the **HYDRO TOUCH** equipment must be disposed of according to current regulations.



Elements such as paper, cardboard, plastic or any other recyclable elements must be taken to a suitable sorting center.



According to European directive 2012/19/EC, this symbol means that as of 4 July 2012 electrical appliances cannot be thrown out together with household or industrial waste. According to current regulations, consumers within the European Union are required, as of this date, to return their used devices to the manufacturer, who will take care of disposing them at no extra expense.



According to European directive 2011/65/EC, this symbol means that the **HYDRO TOUCH** controller is designed in compliance with the restrictions on hazardous substances.



According to low-voltage directive (2014/35/UE) and the electromagnetic compatibility directive (2014/30/UE), this symbol means that the device has been designed in compliance with the previously cited directives.

### 3 Technical specifications

#### 3.1 General specifications HYDRO TOUCH devices

##### 3.1.1 Technical specifications

Main Features		
Type	Specification(s)	Marker(s)
Consumption	850W Max	-
Power supply requirements	230VAC +/-10% 50/60Hz	-
Overvoltage Category	Accept temporary over voltages from power line.	-
Electric protection	Glass 5x20 time-lag 315 mA fuse Glass 5x20 fast time 3.5A fuse (relay protection)	F3 F2
Operating temperature (°C)	0°C to 45°C	-
Storage temperature (°C)	5°C to 30°C	-
Humidity	Max. 90% without condensation	-
Case material	ABS V0	-
Weight	1.8 kg	-
Protection rating	IP 54	-
Display	Tactile LCD 320x240 with white backlight 3.5"	-
Inputs		
Measurement inputs	1x potentiometric (pH) 0-14pH. 1x potentiometric (ORP) 0-+1000mV. 1x RTD (4..20mA) -5..45°C.	PH REDOX TEMP
Control or flow inputs	1x remote input in « control On/off » 1x flow switch detection	SPDT1 SPDT4
Bottom tank	1x input bottom tank for pH channel 1x input bottom tank for ORP channel	SPDT2 SPDT3
Outputs		
Relay	1x powered relay, line supply contact 250mA / 230VAC	RELAY
Pumps	2x powered relay, line supply contact 250mA / 230VAC	PUMP1 PUMP2
Types de pompes		
Pumps	Metering pumps with 4 different flow : 0,4l/h, 0,8l/h, 1,6l/h et 2,4l/h. Acid and oxidant resistant tubes	
Communications		
RS485	1x RS485 communication port	RS485
USB	1x USB slot to connect USB stick mass storage	USB

##### 3.1.2 Main functions

Main Functions		
Function	Specification(s)	Comment(s)
Control/Measure channels	<b>pH</b> function scale  <b>ORP</b> function scale	<b>Scale : 4,00 à 14,0pH</b> Resolution : 0,01 pH if pH < 10 Accuracy : 0,5% <b>Scale : 0 à 999mV</b> Resolution : 01mV Accuracy : 0,5%
Regulation mode	<b>On / Off</b> with hysteresis or <b>Linear</b> with proportional cycles (Std)	Control from 0 to 100% of programmed scale
Setpoint	<b>pH</b> : 6 to 9 pH by step of 0,01pH <b>ORP</b> : 300 to 950mV by step of 1mV	
Direction	Up or down function(s)	
Alarms	Low and high measurement value, sensors fault, overdose timeout	Control of high and low thresholds.

Closed-loop control	Remote control	Filtration contact.
Timer	Programming the relay on timer	8 slots per days
Calibration	With a hand-held device or with reagents (cf accessories).	
Maintenance	Maintenance helper	Control of dosing actuators to prime the pump

### 3.2 Installation of the wall mounted devices

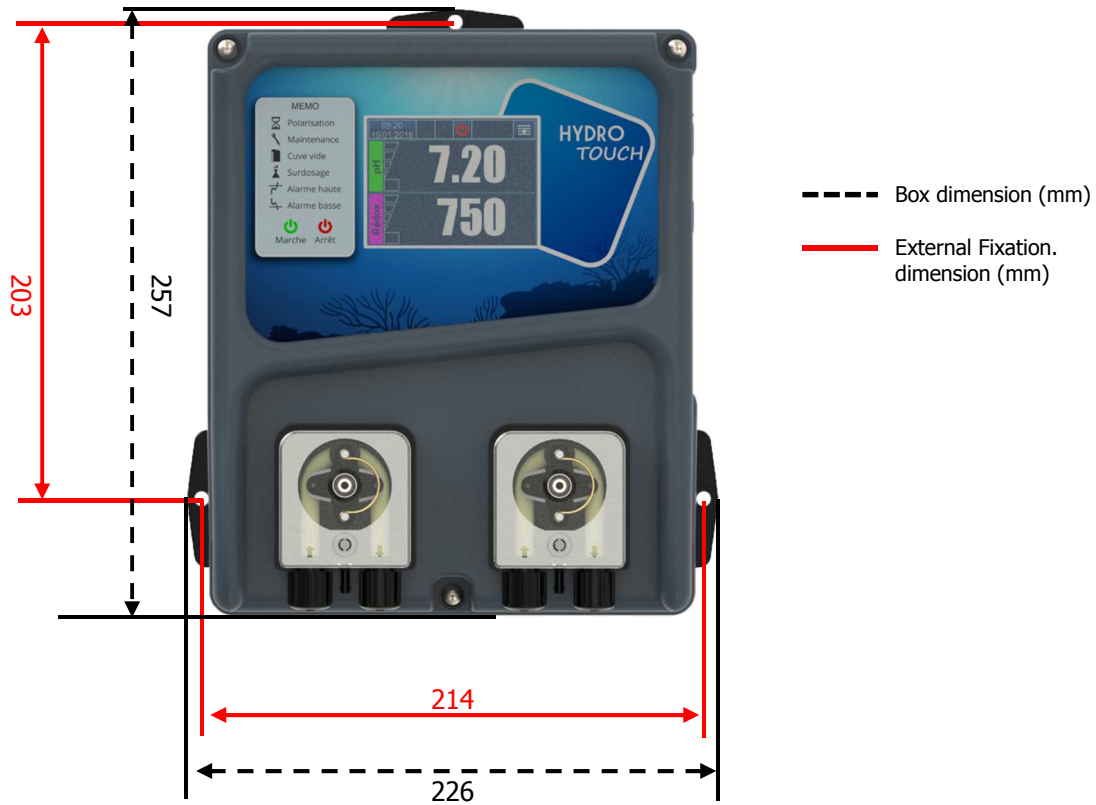

## 4 Installation and electrical connections

### 4.1 Installation conditions



To guarantee the user safety and to ensure correct operation of your **HYDRO TOUCH**, please observe the following installation instructions:

- Install the controller in a dry location,
- The controller must be protected against rain, frost and direct sunlight,
- The room temperature must range between 0°C and 50°C, with no condensation,
- Choose an installation location free from vibration, on a suitable support and with no deformation.



If these instructions are not observed:

- The controller risks to be damaged,
- The measurements can be disrupted,
- The warranty is not applicable!

### 4.2 Wall installation conditions

- ✓ Dry and dusted place
- ✓ Operating ambient temperature between 0°C and 45°C.
- ✓ Installation location out of vibrations
- ✓ Clean, non distorted support
- ✓ Correct wall fixing



**CAUTION :** *Respect mounting instructions. In case of non-compliance:*

- *The unit may be damage*
- *Measurements may be disturbed*
- *The warranty will not be insured !*

### 4.3 Wall installation of control device



**DANGER :** *Prior to installing the devices and connections of cables, pipes and fittings, cut power supplies!  
The IP54 protection class is guaranteed only if the closure caps of the **HYDRO TOUCH** are closed and the wires correspond to the diameter of the cable gland!*

#### Mounting procedure of HYDRO TOUCH box

1. Shutdown general power supply.
2. Make sure the filtration pump is off.
3. Close the valves of the hydraulic system and put the filter valve on « Off »
4. Drill 3 holes of Ø 8mm according to previous plan using or not the fixation kit provided for this purpose. (If mounting without kit the drilling dimensions are different!)
5. Insert 8 mm raw plugs with a hammer.
6. Fix the upper screws and tighten the lower screws once in place



**CAUTION :** *When closing the protection cover, take care not to damage the gasket or pull the cables between the cover and the electronic card!*

**4.4 Installation of pipe saddles for sensors and products injection**



**CAUTION :**

*The installation of the pipe saddles depends on your pool and the necessary space available!*

**4.4.1 Different situations may arise**

**1<sup>st</sup> case** (The most common and recommended)

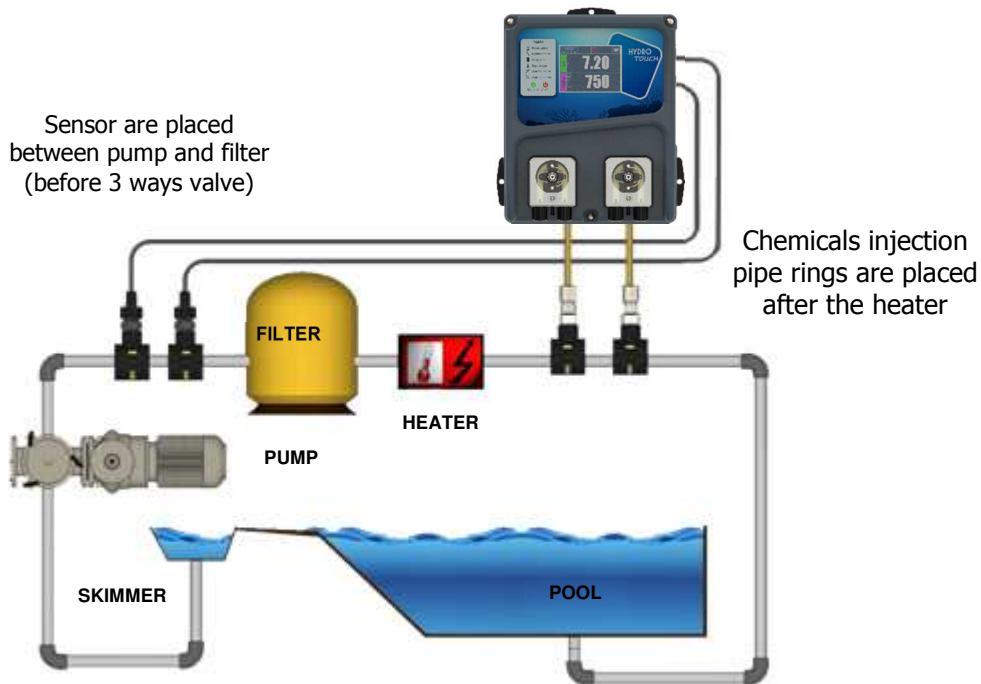

**2<sup>nd</sup> case**

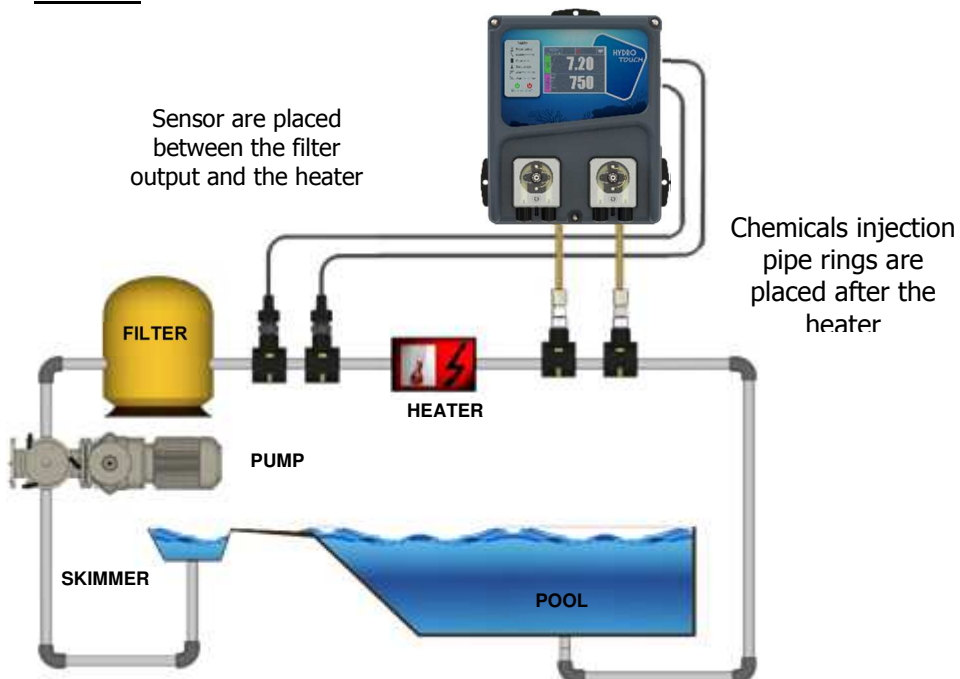

**3<sup>rd</sup> case**

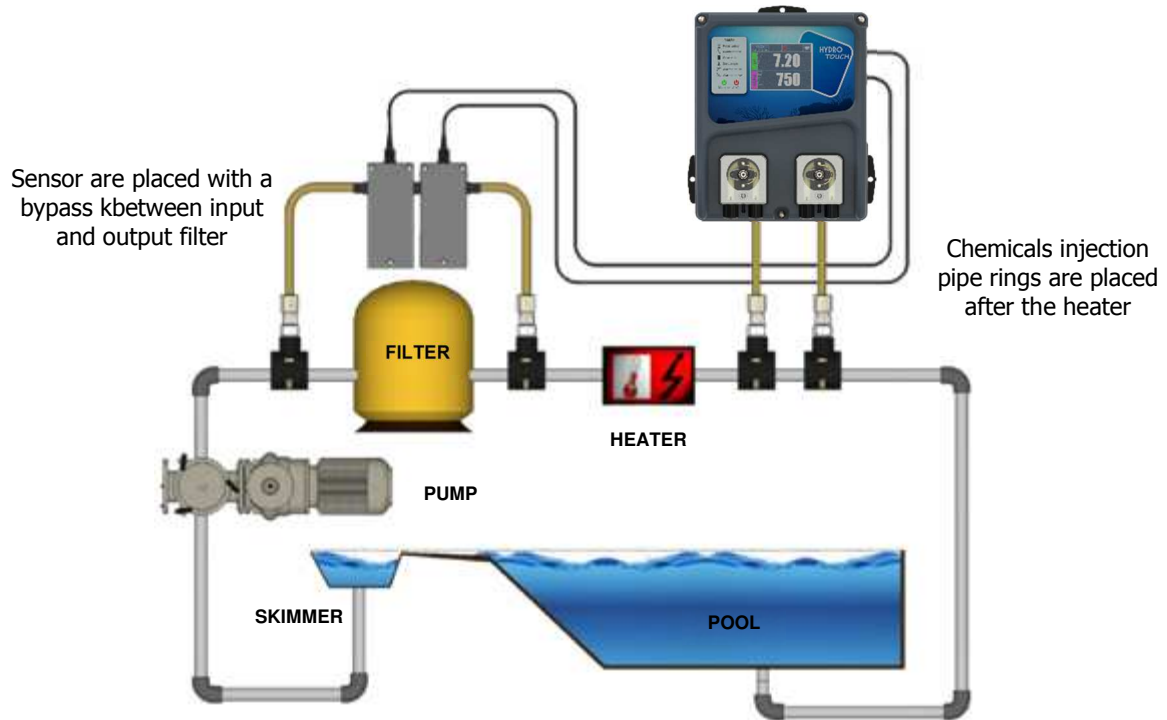

**4.4.2 Mounting procedure of pipe saddles**

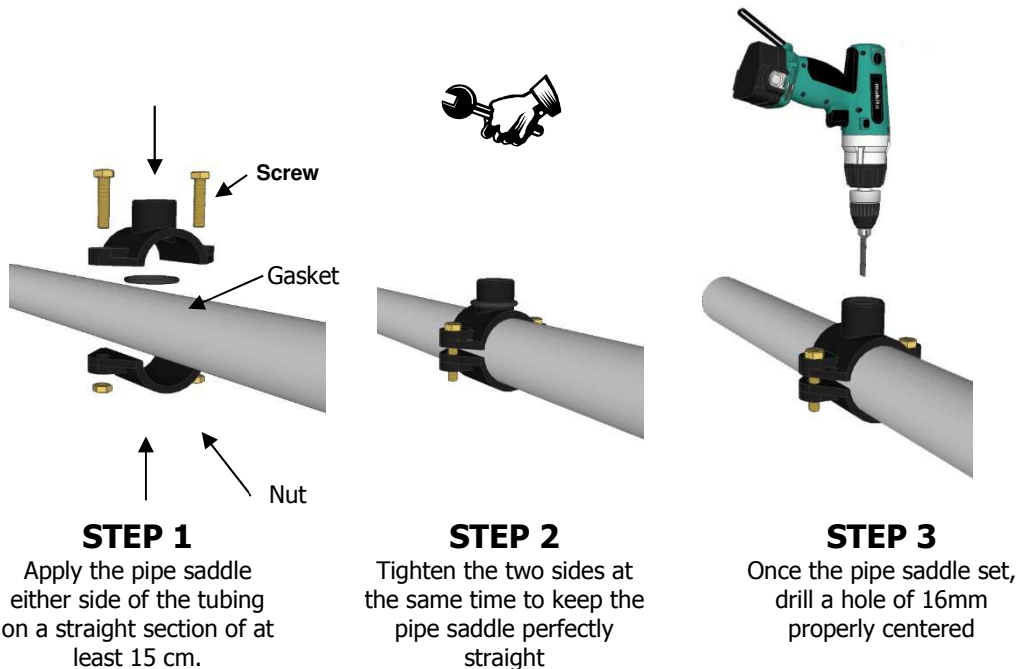

#### 4.4.3 Mounting procedure for sensors connection kit

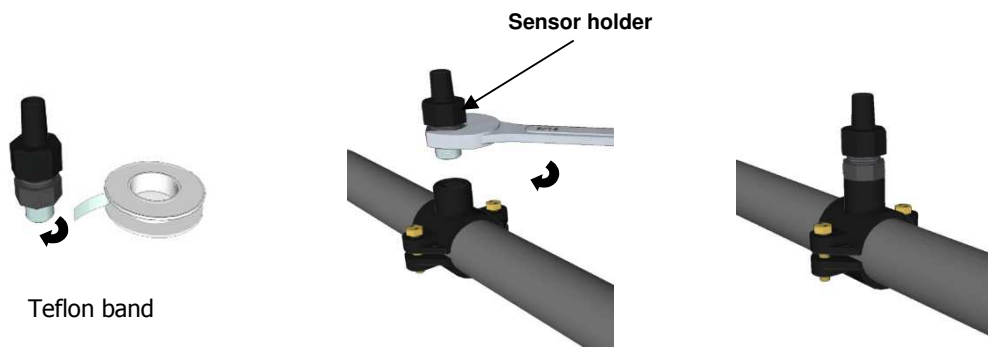

Teflon band

#### STEP 4

Put teflon on the « sensor-holder » threads.

#### STEP 5

Mount the "sensor- holder" on the pipe saddle. Tighten gently and finish with the wrench.

#### STEP 6

The « sensor holder » is mounted, wait the end of the installation to assemble the sensors



#### Note :

*pH sensors can be mounted to à +/- 360°. However, we recommend performing this assembly to the vertical: maintenance is easier to achieve!*

#### 4.4.4 Mounting procedure for pipes connection kit



Teflon band

#### STEP 7

Put teflon on the threads of the fitting and injection valve.

#### STEP 8

Screw the fitting on the pipe saddle

#### STEP 9

Screw the injection valve on the fitting



#### STEP 10

Unscrew the cap from the injection valve...

#### STEP 11

Pass the PE pipe into the cap and fit it on the valve cone...

#### STEP 12

Screw the cap with the PE pipe on the valve.





**STEP 13**  
Same operation on the dosing pump side.



**STEP 14**  
Screw the cap with the PE pipe on the pump

**4.4.5 Mounting procedure for flexible suction pipe**

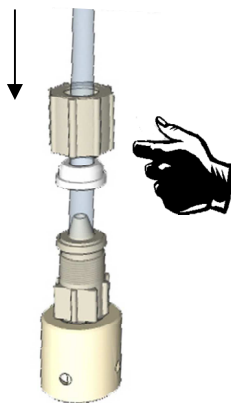

**STEP 15**  
Unscrew the cap and pass the clear pipe



**STEP 16**  
Tighten the nut on the cone...



**STEP 17**  
Screw the clear pipe on the metering pump...



**STEP 18**  
Tighten the nut on the metering pump.

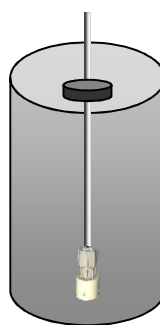

**STEP 19**  
Place the bottom tray valve weighted and adjust the depth...



**STEP 20 (option)**  
Place the sensor level and its weight and adjust.

#### 4.4.6 Mounting procedure of the pH sensor

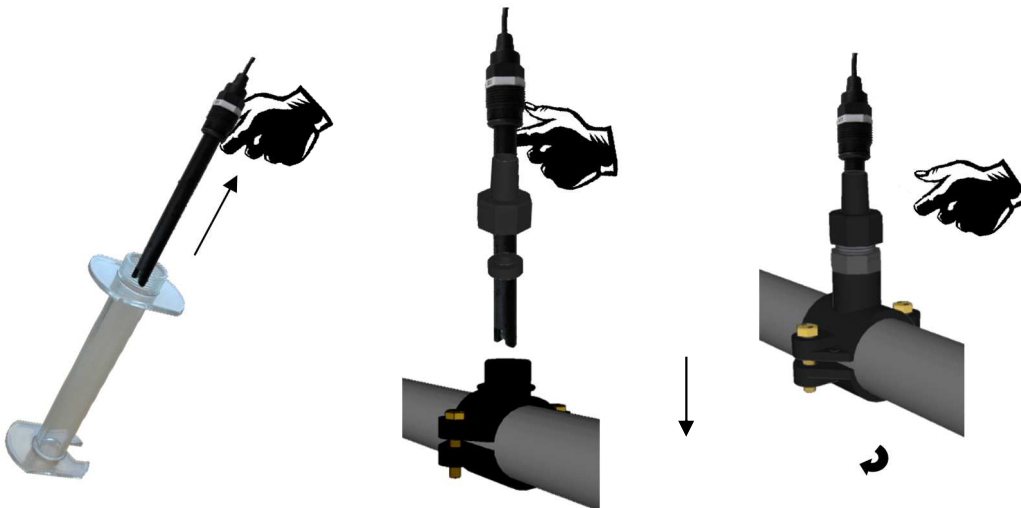

##### STEP 21

Remove the cap from the sensor and unscrew the nut of the "sensor holder"

##### STEP 22

Slide the nut on the sensor and gasket down, then place the sensor.

##### STEP 23

Hand tighten the nut of the "sensor-holder"  
The sensor is ready!



##### NOTE :

*Proceed in the same way for both probes if necessary!*

#### 4.4.7 Connecting the pH and ORP sensors on the HYDRO TOUCH device



##### Step 24

Fit the connector to the sensor

##### Step 25

Rotate a quarter turn to lock the connector without forcing

##### Step 26

Perform the same operation for the second connector if necessary

The BNC inputs of pH sensor of **HYDRO TOUCH** controllers are « high impedance » inputs. They must be kept clean and free of moisture or corrosion



##### CAUTION :

*The BNC connectors must be kept clean and free of moisture or corrosion.*

## 4.5 Commissioning / Electrical connections



**DANGER :**

*Facilities must be made according to rules in force!  
A differential circuit breaker of 30mA must be present and a fuse or circuit breaker must be installed!*



**DANGER:**

*Connections must be performed by a skilled technician !*



**DANGER:**

*Before making connections, cut power supplies!*

### 4.5.1 General connections

**HYDRO TOUCH** controllers must be supplied with electric power protection using the nameplate located on the side of the device.

For safety, controllers supply must be cut when the filtration is off.



**CAUTION :**

*The electrical connection of the **HYDRO TOUCH** device must necessarily be coupled with the operation of the pool filtration.  
The CAD input, remote control, (Potential-free input, do not connect 220V power supply or other on this input) can be used to make this condition.*



**NOTE :**

*Hydro' boxes are already provided with a suitable power cable!  
If this cable is supplied with a plug, an identical base must be installed near the unit. Anyway, the wiring stays the same in the filtration case!*

#### 4.5.1.1 Case of a single phased filtration box in 230V 50Hz

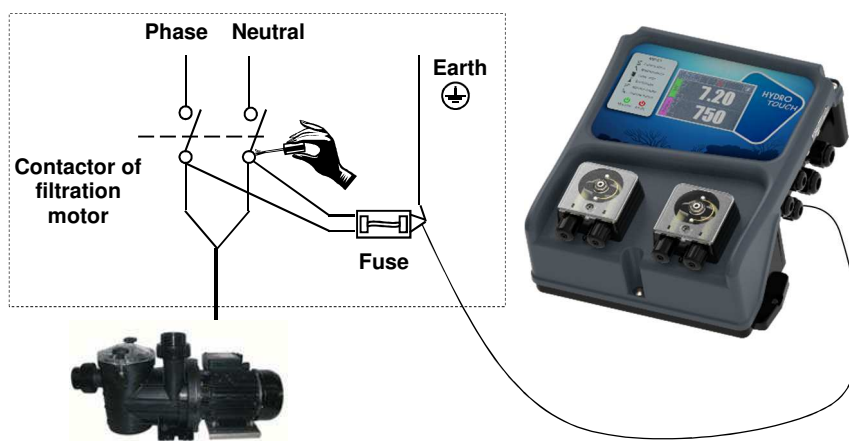

4.5.1.2 Case of a single phased filtration box in 380V 50Hz

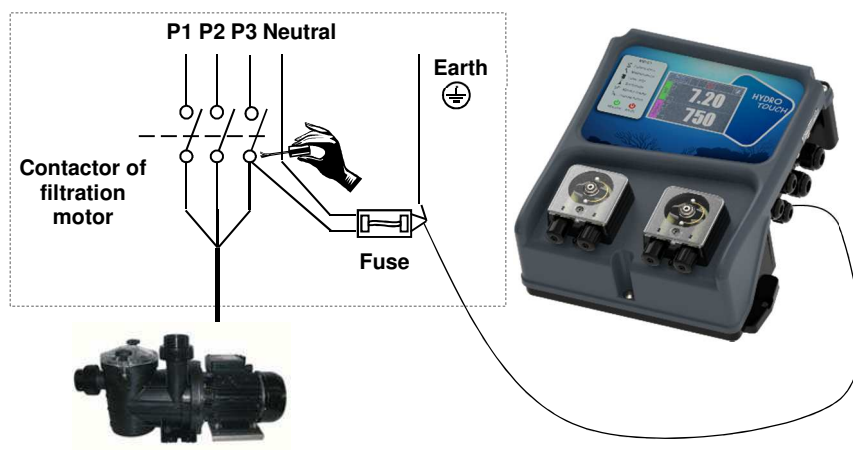

**NOTE :**

*In both cases, connect « Neutral and a phase » and Earth!*

## 4.5.2 Changing the internal protection fuse

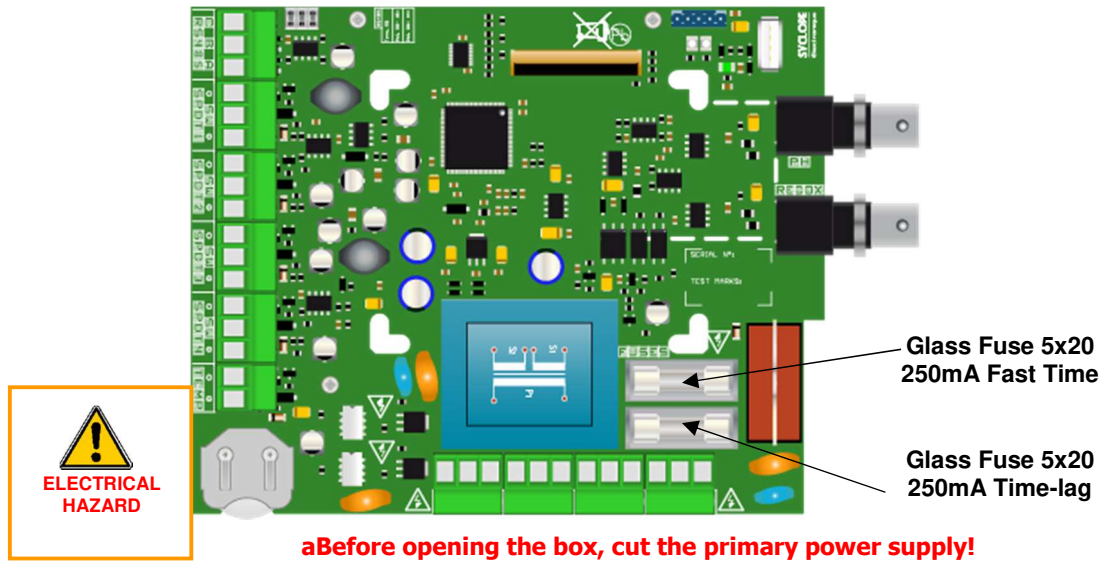

**DANGER :**

*Before changing the fuse, cut power supplies*

### Procedure for changing fuses :

1. Cut the primary power supply.
2. Locate the fuse to change according to the diagram.
3. Change the fuse with an identical fuse.
4. Replace the front cover and fixation screws.
5. Commission the equipment.



**DANGER :**

*Fuse replacement must be performed by a qualified technician !*



**CAUTION :**

***Deteriorated fuses must imperatively be replaced by fuses of identical intensity and technology!***



**NOTE :**

*If a fuse is destroyed, it is imperative to identify the cause before replacing it!*

## 4.5.3 Specific connections

### 4.5.3.1 Free of potential switch connection

The **HYDRO TOUCH** controller has four remote control input (SPDT1 - SPDT4) used in a subservient manner to the main circulation pump of the filtration system. There are free of potential switch inputs.



**CAUTION :**

It is imperative to enslave the controller to the switch of the filtering group's motor to prevent damages caused by chemical overdoses!

**NOTE :**

*Inputs are designed to receive a NO contact (normally open),  
a NC (normally closed)  
The contact may be dry PNP or NPN type.*

## a) Proximity sensor connection (NPN, PNP)

1. Cut the primary power supply.
2. Remove the protective sheath
3. Strip the wires for 7mm.
4. Pass the cable through a cable gland.
5. Wire the three points of switch to **(SW)** , (+) and (-).
6. Tighten the cable gland to ensure tightness.
7. Replace the front cover and fixation screws.
8. Commission the equipment.

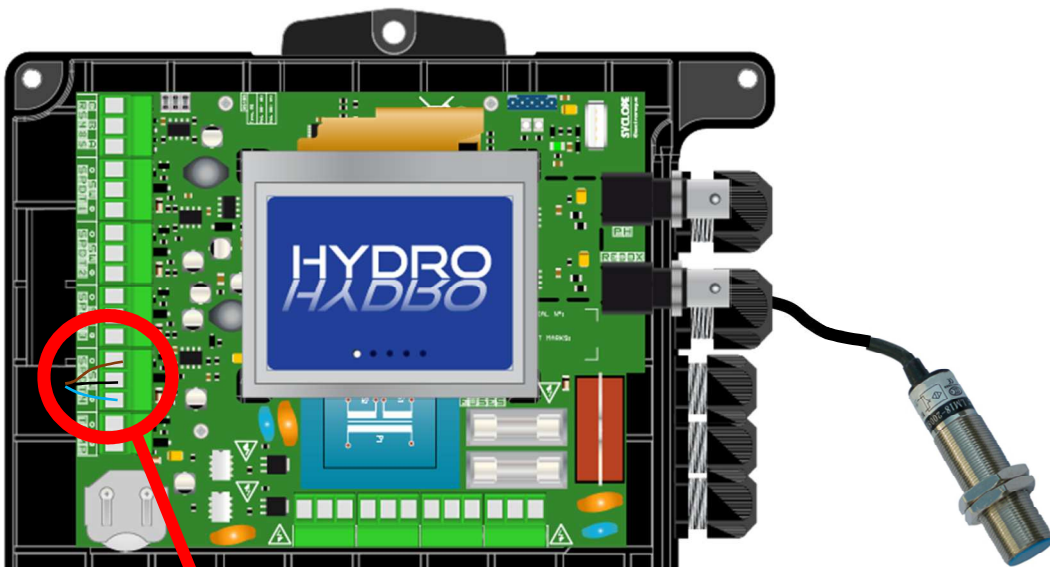
**NOTE :**

*The SPDT4 input is dedicated to the flow switch  
function*

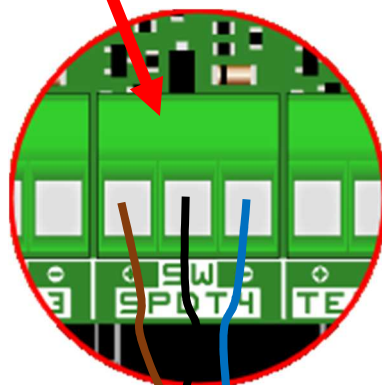

b) Free of potential switch connection

1. Cut the primary power supply
2. Remove the protective sheath
3. Strip the wires for 7mm.
4. Pass the cable through a cable gland.
5. Wire the two points of switch to **(SW)** and **(+)**.
6. Tighten the cable gland to ensure tightness.
7. Replace the front cover and fixation screws.
8. Commission the equipment.

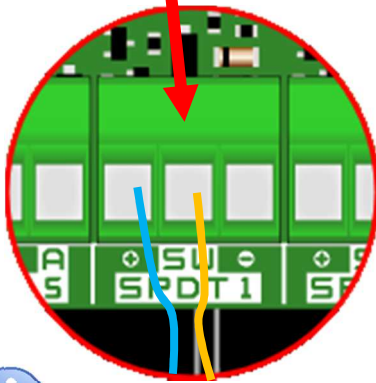
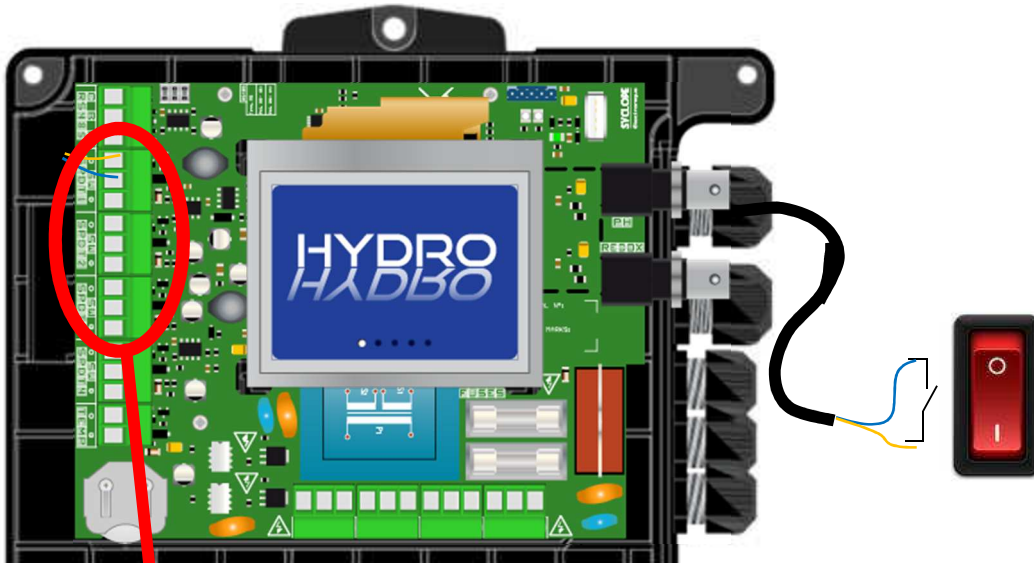

**CAUTION :**

*In case you need to detect filtering motor you must use an external relay to drive a free potential switch.*



**NOTE :** *The SPDT1 input is dedicated to the remote control contact.*

*The SPDT2 input is dedicated to the pH bottom tank.*

*The SPDT3 input is dedicated to the ORP bottom tank.*

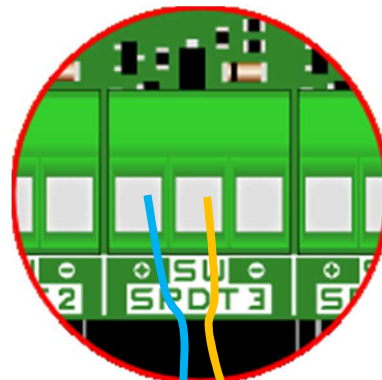
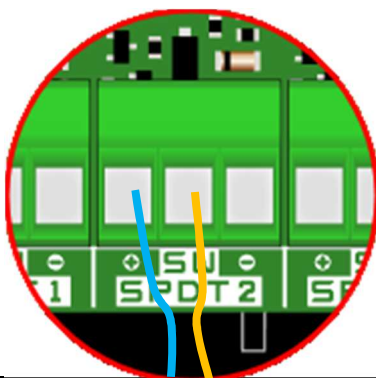

#### 4.5.3.2 Temperature sensor connection (4...20mA)

This input is dedicated to connect a SYCLOPE 4-20mA temperature sensor -5°C – 45°C (CAT2602 ou CAT2509).

1. Cut the primary power supply.
2. Remove the protective sheath.
3. Strip the wires for 7mm.
4. Pass the cable through a cable gland.
5. Wire both wires with the correct polarity
6. Tighten the cable gland to ensure tightness.
7. Replace the front cover and fixation screws
8. Commission the equipment

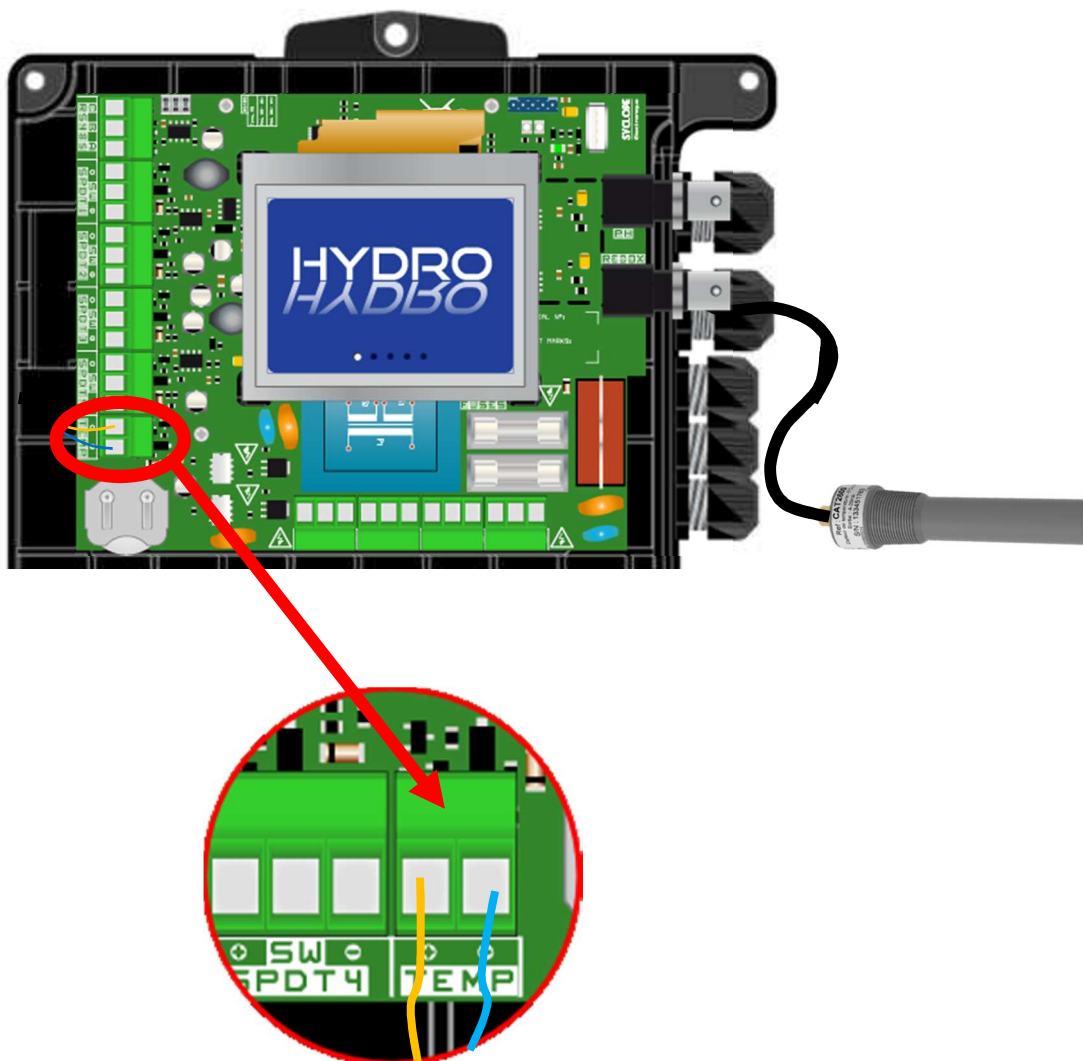



### 4.5.3.3 Powered relay connection

The powered relay (main power supply) is used in timer mode or to send technical alarms.

1. Cut the primary power supply.
2. Use minimum **1.5mm<sup>2</sup>** wires.
3. Remove the protective sheath.
4. Strip the wires for 7mm.
5. Pass the cable through a cable gland.
6. Wire Earth on PE.
7. Wire ligne on L
8. Wire neutral on N.
9. Tighten the cable gland to ensure tightness..
10. Replace the front cover and fixation screws
11. Commission the equipment

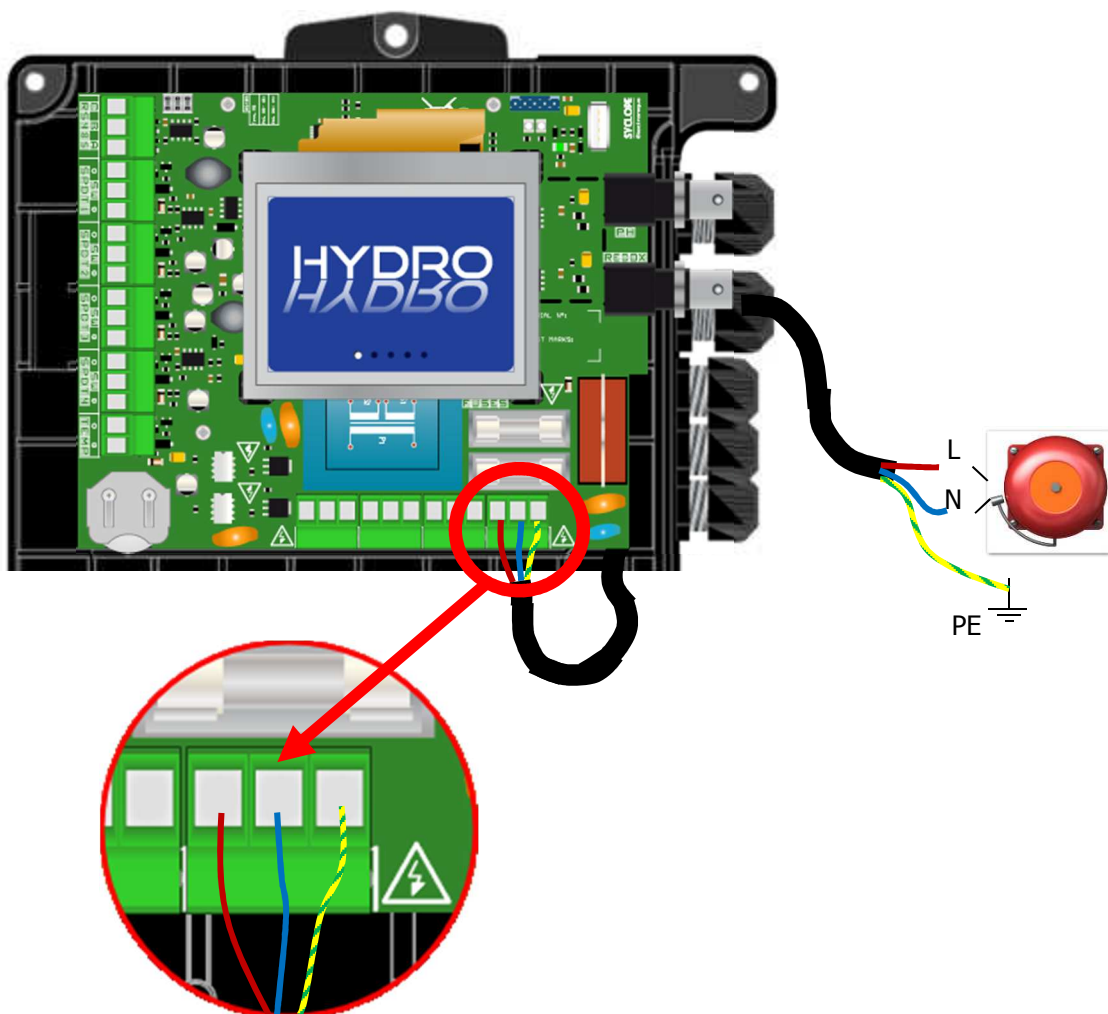

**DANGER :**

*This relays switch the Ligne from the mains supply of the device. The neutral link is permanent and unswitched. Care must be taken not to reverse the phase and neutral lines. To avoid any electric shock you must switch off the device beetwen connect the relay.*

---

#### 4.5.3.4 RS485 communication port connection

The **HYDRO TOUCH** controller has an RS485 communication port for linking with a **HYDROCOM** to trace measurements, alarms, instructions and display graphics.

1. Cut the primary power supply.
2. Remove the protective sheath
3. Strip the wires for 7mm.
4. Pass the cable through a cable gland.
5. Wire A of the network on **RS485** (A).
6. Wire B of the network on **RS485** (B).
7. Wire C of the network on **RS485** (C).
8. Tighten the cable gland to ensure tightness.
9. Replace the front cover and fixation screws.
10. Commission the equipment.

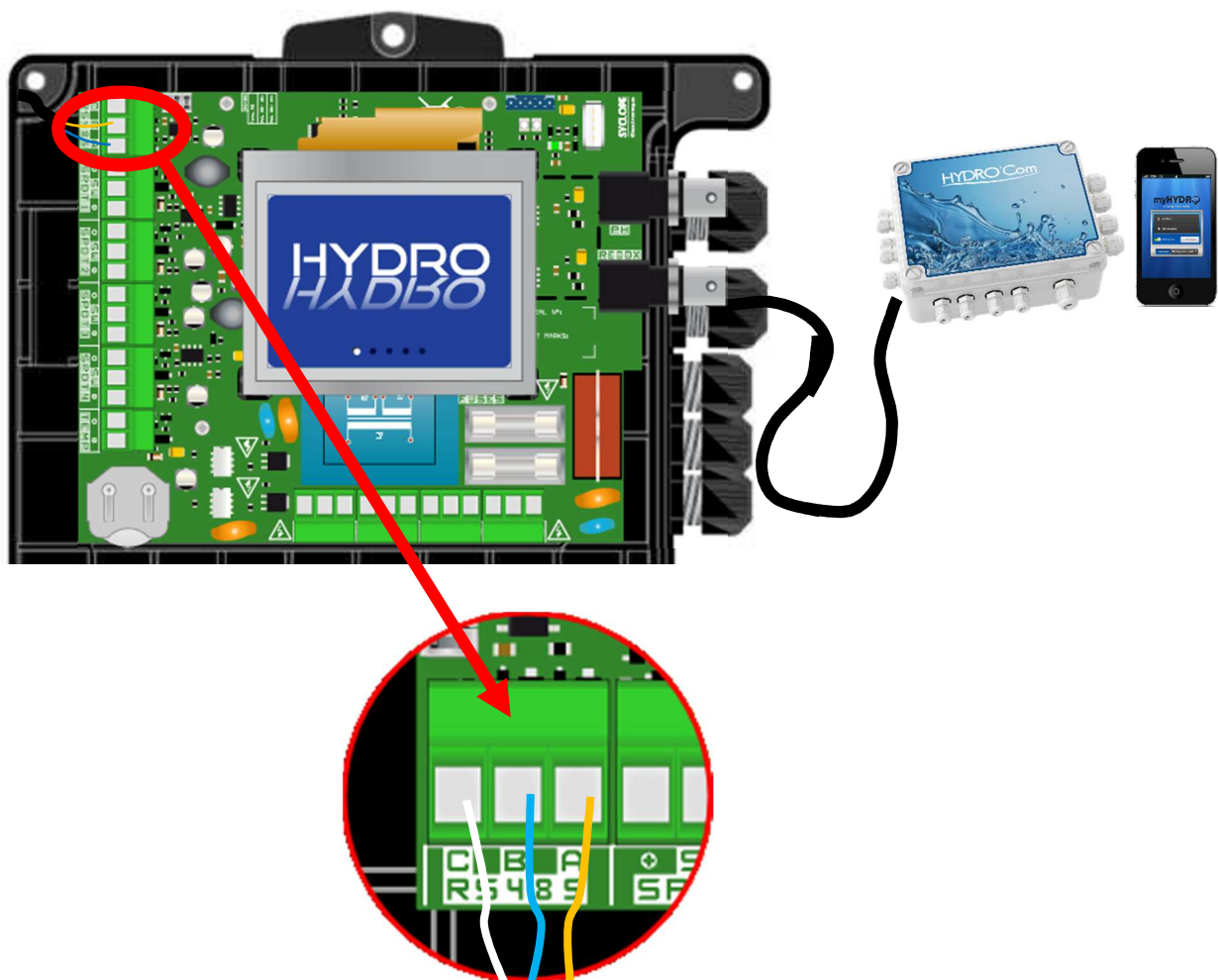

#### 4.5.3.5 USB stick connection

The **HYDRO TOUCH** controller has a USB slot to connect a stick mass storage. This function allows you to do firmware updates.

1. Cut the primary power supply.
2. Connect the USB stick.
3. Commission the equipment
4. Wait the firmware update
5. Cut the primary power supply.
6. Disconnect the USB stick.
7. Replace the front cover and fixation screws.
8. Commission the equipment.

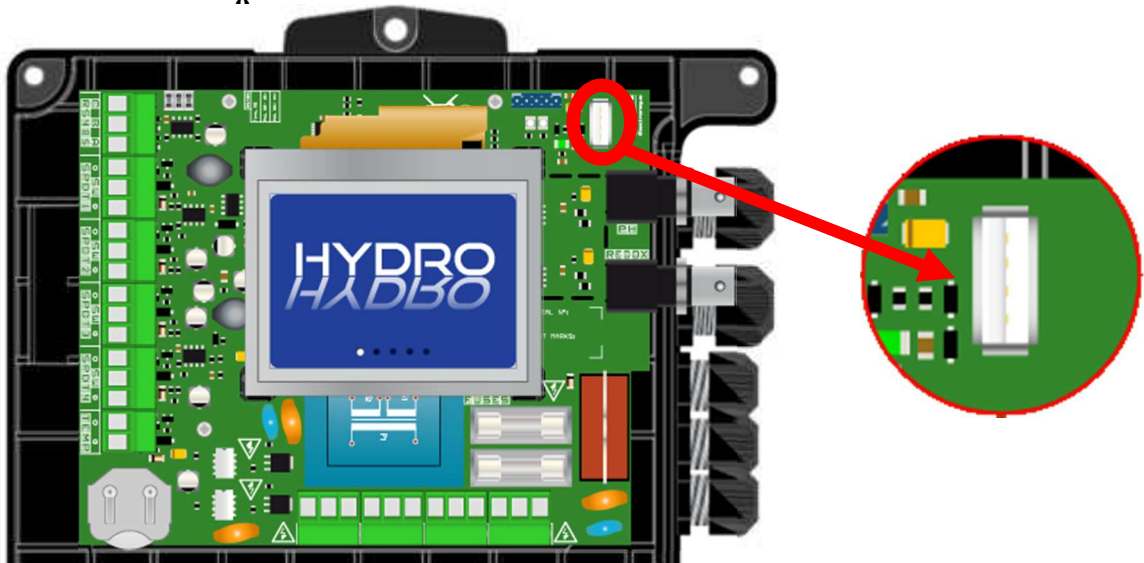

**DANGER :**

*Update must be performed by a skilled!*

#### 4.6 Filing the tanks of chemical



**NOTE :**

*The chemicals used in pools can be dangerous and corrosive!  
They can damage your health and cause environmental damages.  
Any mixture of chemicals can be hazardous to health and should never be done!*



**NOTE :**

*The products can also be « ready-prepared ». In this case, right introduce directly the valve in the tank.*

## 5 HYDRO TOUCH controller presentation

You have completed the electrical connections of the various sensors and actuators and are now ready to start the **HYDRO TOUCH** controller.



1. Connecting the controller to the main power line.
2. Checking that all systems are correct, that your central unit has switched on and that the other elements of your installation are not disrupted.

### 5.1 General operation

**HYDRO TOUCH** range devices are used to measure and control the pH (potential of hydrogen) and /or the ORP (potential of Oxydo-reduction), of private swimming pools using specific sensors and commands of actuators suitable in the context of the possibilities of use described in this manual.



**WARNING :**

*Any other use is considered improper and should be outlawed. SYCLOPE Electronique S.A. will not take on the liability and damages that result.*



**NOTE :**

*The **HYDRO TOUCH** controller does not start automatically the controls of chemical products when powered. Only the user can control when to begin treatment having checked that the central unit has been correctly programmed according to his/her needs*



**NOTE :**

*The chemicals used in pools can be dangerous and corrosive!  
They can damage your health and cause environmental damages.  
**HYDRO TOUCH** are devices of quantification of these products that meet the current standards!  
Any mixture of chemicals can be hazardous to health and should be forbidden!*



**NOTE :**

*Since their commissioning, and once a month, using a colorimetric analysis kit or standard samples, check the various settings displayed by the device. If necessary, make the correction of measure(s).*

**▲ See section « calibrations »**



**CAUTION :**

*The sensors are fragile! Make sure they operate. In case of major fault, immediately call the technical department of your retailer who will give you the instructions to follow!*



**WARNING :**

*Before performing operations on the devices, ensure that the circuit of the pool is in mode « filtration »!  
Measurements can be correct only if the sensors are irrigated by water from the pool*

**NOTE :**

*Never inject chemicals into waterless piping or without circulation. The mixture of chemicals can be hazardous to health and may cause severe eye, skin or mucous membranes lesions!*

## 5.2 **Human interface generality**

The **HYDRO TOUCH** regulator has a 3.5 " touch screen. All the commands are done by pressing on the screen on the zones envisaged for this purpose.

The **HYDRO TOUCH** regulator has two levels of programming allowing to improve the safety of the treatment and the people:

- The user level allows access to the basic settings of the controller
- The installer level allows access to all controller settings for a complete modification of the machine. This level is protected by an access code

### **Tree and programming index**

5.3	Main display .....	30
5.4	User level settings .....	30
5.4.1	Headband settings .....	30
5.4.2	Set current date and time.....	31
5.4.3	Display details of a channel .....	32
5.4.4	Channel settings .....	33
5.4.5	Input screen for a numerical value .....	34
5.4.6	Programmation screen .....	34
5.4.7	Interface management .....	35
5.4.8	Brightness and contrast management.....	35
5.4.9	Screen protection managment.....	36
5.4.10	Colors managements.....	36
5.4.11	Change installator code .....	37
5.4.12	System information .....	37
5.5	Installator level settings .....	38
5.5.1	pH channel settings.....	39
5.5.2	ORP channel settings .....	42
5.5.3	Temperature channel settings.....	45
5.5.4	Timers settings .....	46
5.5.5	General settings.....	47
5.5.6	Communications settings.....	48
5.5.7	Advance settings.....	49
5.6	pH and ORP channel calibration.....	50
5.6.1	Automatic ph and ORP channel calibration (without reagents) .....	50
5.6.2	Manuel ph and ORP channel calibration (with reagents) .....	51
5.6.3	Calibration reset.....	53

### 5.3 Main display

As soon as you turn on your device, the startup screen appears with the **HYDRO TOUCH** controller logo. Then, the main screen appears with the display of measured parameters.

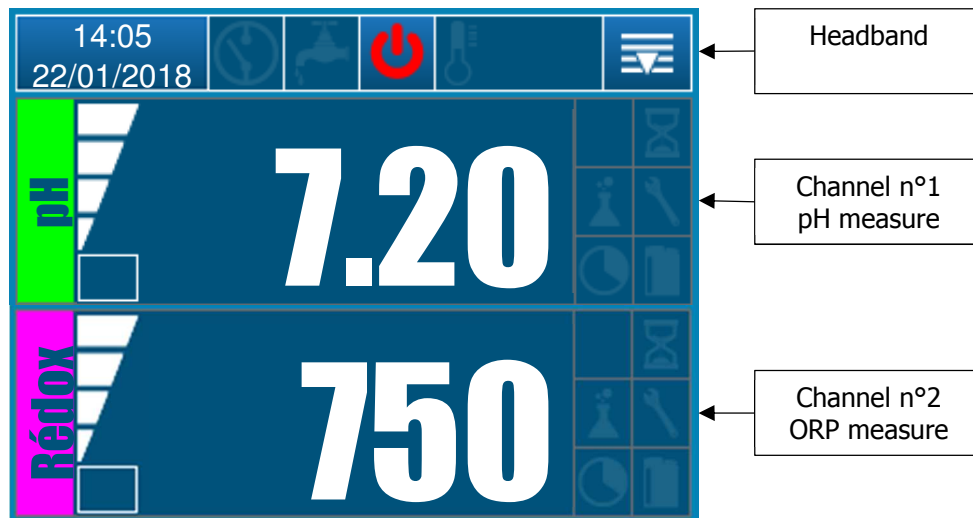

### 5.4 User level settings

#### 5.4.1 Headband settings

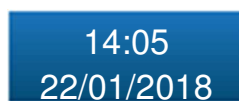
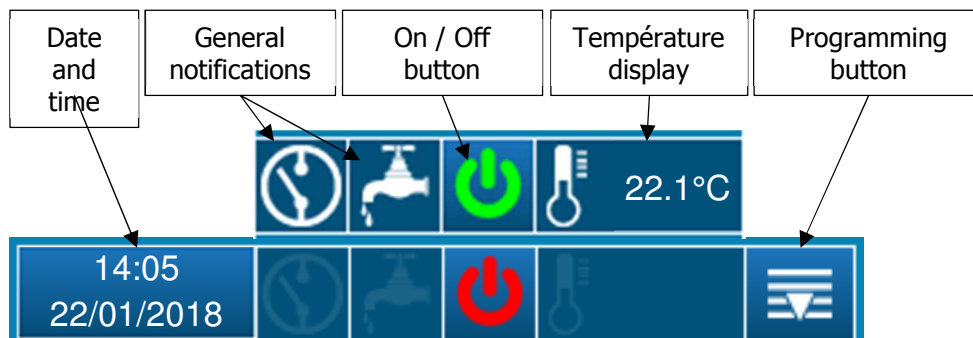

This button is used to set the date and time. Press to open the setting menu



When this icon is present, it indicates that the remote input is in alarm.



When this icon is present, it indicates that the flow switch input is in alarm.



Controller running (green icon) - Press to turn the controller off.



Regulator stopped (red icon) - Press to turn the controller on.



This icon is used to display the temperature



This button is used to access the menu for programming the machine parameters. Press to open the menu

---

### 5.4.2 Set current date and time

02:05 PM  
01-22-2018

Press the date and time field to make this setting.

- Unchecking the "24h hour format" box will allow you to display the time in 12h format.
- Ticking the "US Date Format" box will allow you to display the date in mm / dd / yyyy format

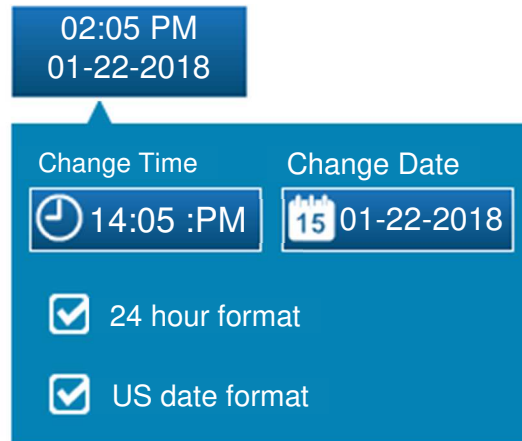

**NOTE :**

*The time setting of the controller will be effective when closing the screen, by pressing the date and time field.*



**NOTE :**

*If the time programming screen closes on its own by exceeding the waiting time, the set time will not be saved.*

### 5.4.3 Display details of a channel

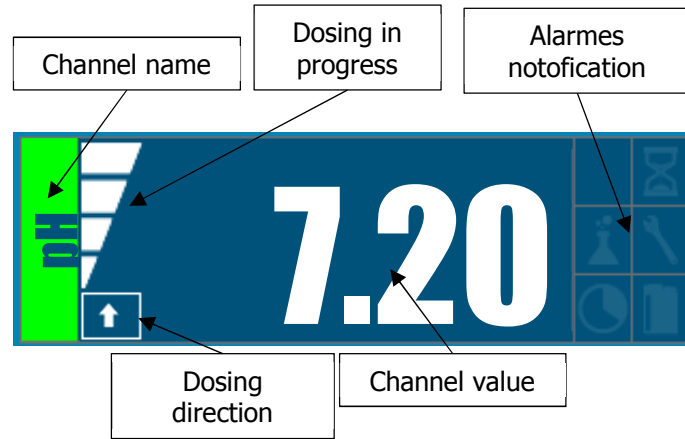

This icon lets you know the direction of dosing (upstream or downstream) set of the channel.



This icon lets you know the percentage of dosing in progress of the channel. Example here the dosing is 75%.



This icon lets you know if the low alarm is active.



This icon lets you know if the high alarm is active.



This icon lets you know if if a polarization time delay is



This icon lets you know if the overdose alarm is active.



This icon lets you know if the sensor need to be calibrated or changed



This icon lets you know if the Timer is active.



This icon lets you know if the bottom tank alarm is active.



Measured value



Value lower than the scale



Unmeasurable value



Value higher than the scale



#### 5.4.4 Channel settings



**Note :**

*To display this screen, you must press the desired channel from the main screen.*

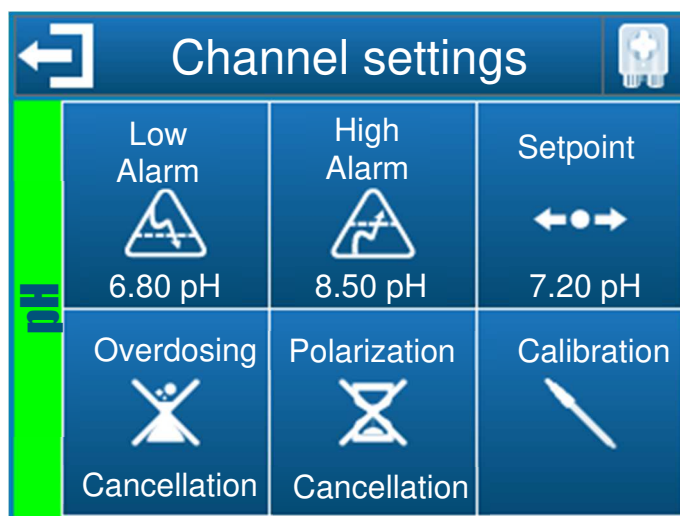

This button allows you to leave this screen and record the new parameters of the channel.



This button allows you to prime the pump of the channel.



This button allows you to set the low alarm threshold of the channel.



This button allows you to set the high alarm threshold of the channel.



This button allows you to set the setpoint of the channel.



This button cancels the overdose alarm of the channel.



This button cancels the polarization alarm of the channel.



This button allows you to calibrate the channel.  
Cf. chapter 5.6 pH and ORP channel calibration



**Note :**

*The configuration of the channel will be effective when closing the screen, pressing the return and validation field.*



**Note :**

*If the channel configuration screen closes itself by exceeding the waiting time, the parameters will not be saved.*

### 5.4.5 Input screen for a numerical value

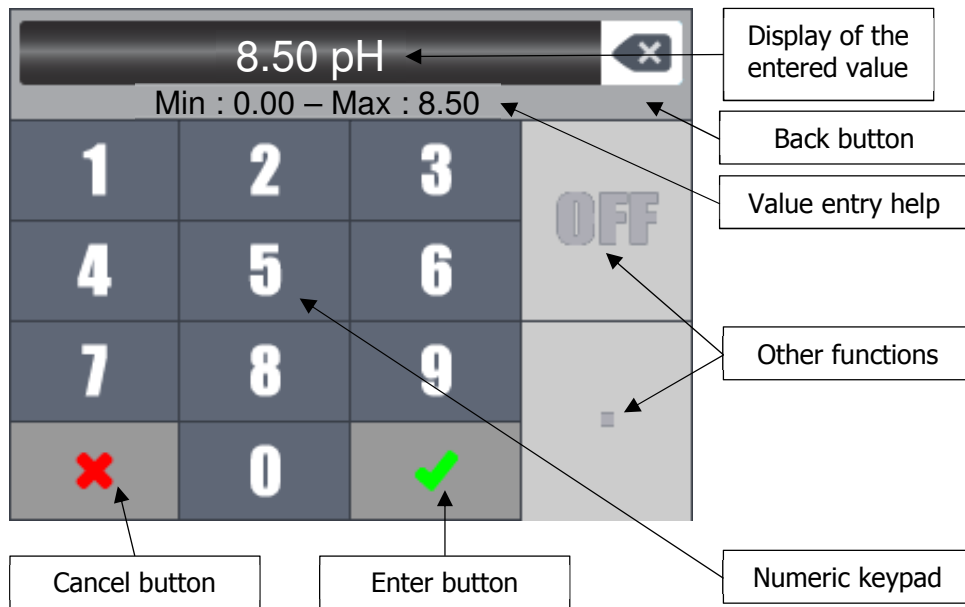

**Note :**

*Depending on the values to be entered some keys may be grayed out because not used for the expected value.*



**Note :**

*If the value entered is out of range, when validation the input help area will be displayed in red to alert you of the input error.*



The "OFF" key allows to disable a value, for example, to disable a timer.

The « AM/PM » key allows to set a date with a 12hours format.

### 5.4.6 Programmation screen

**Note :**

*To display this screen, you must press the button  from the main screen*



### 5.4.7 Interface management



This button opens the controller interface configuration screen.

Press on this button to display the next screen.

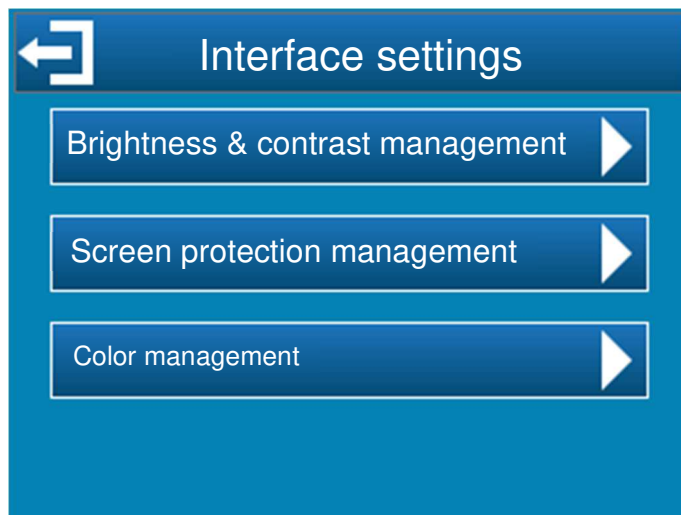

### 5.4.8 Brightness and contrast management

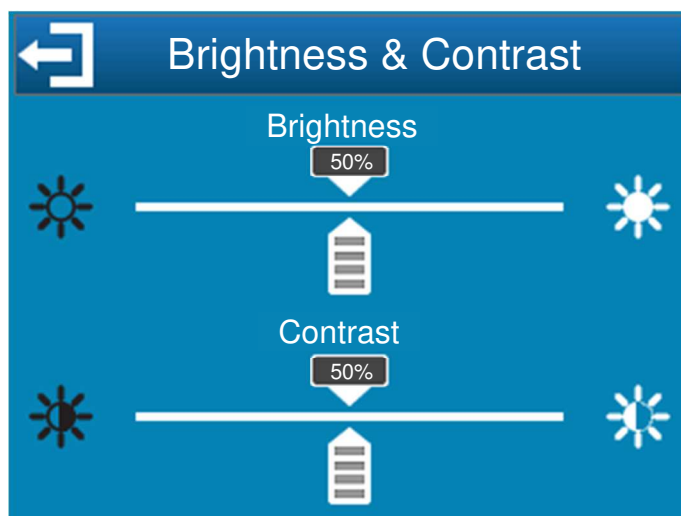

**Brightness** : This button allows to set the brightness between 10 to 100%.

**Contrast** : This button allows to set the contrast between 10 to 100%.

### 5.4.9 Screen protection management

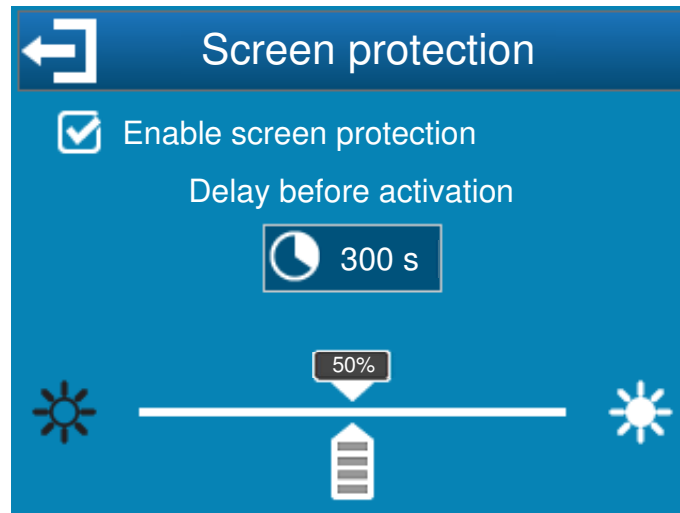

**Enable screen protection:** Check this box to activate the protection function of the screen, it is then possible to select the parameters of the delay



**Delay :** Delays before activation of the screen protector. This time corresponds to the consecutive time without any support on the screen



**Backlight intensity :** This button decreases the intensity of the backlight according to the need.



**Note :**

*When the screen protector is active, you have to press the screen to exit.*

### 5.4.10 Colors managements

This menu will allow you to configure the measurement channel colors as well as the alarm color when there is a problem on a measurement

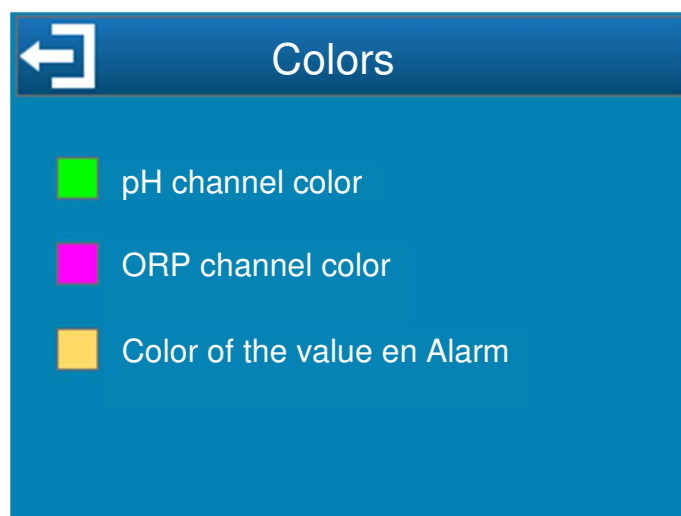

### 5.4.11 Change installer code

The main controller parameters are protected by an installer code. The default code is "1234". This code can be changed in three steps:

1. Enter the current code
2. Enter the new code
3. Confirm the new code

### 5.4.12 System information

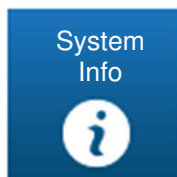

This button opens the system screen information of the controller.

Press on this button to display the next screen.

This window allows you to know the firmware version information of your controller. This information will be useful in case of communication with the technical service SYCLOPE Electronique..

The last field corresponds to the serial number of your controller, identical to the one on the label outside the case.

## 5.5 Installer level settings



After entering the installer code, the configuration screens appear

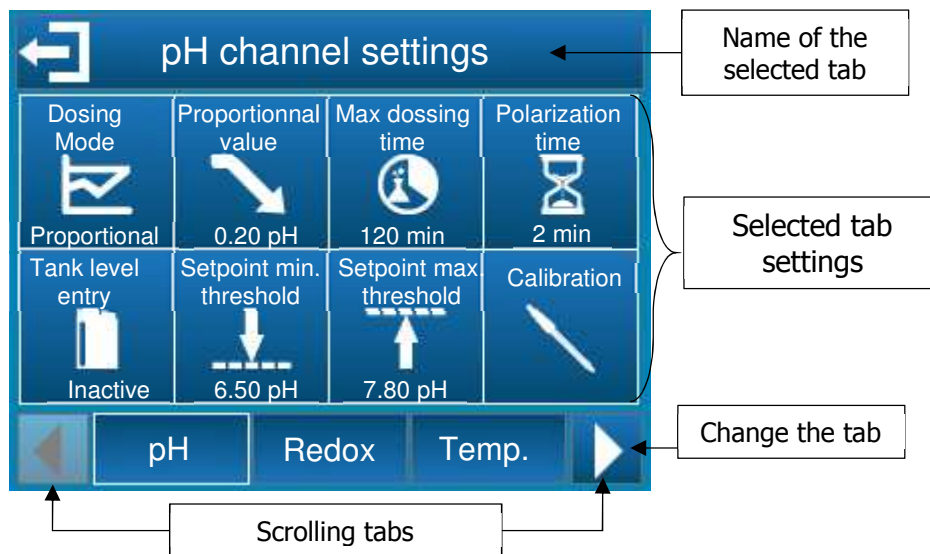

**The selectable tabs are :**

pH	pH channel settings (Dosing mode, tank level, etc.).
Rédox	ORP channel settings (Dosing mode, tank level, etc.).
Temp.	Temp channel settings (display,unit, etc.).
Horloges	Timer channel settings (Start, end time).
Général	General controller settings (Remote input, dosing direction, etc.).
Com	Communication controller settings (speed, parity, etc.).
Avancé	Advanced controller settings (language, factory settings etc.).

## 5.5.1 pH channel settings

### 5.5.1.1 Settings

This screen is used to adjust the parameters related to the pH measurement

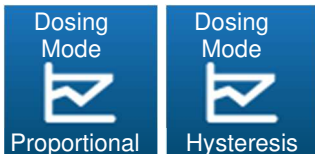
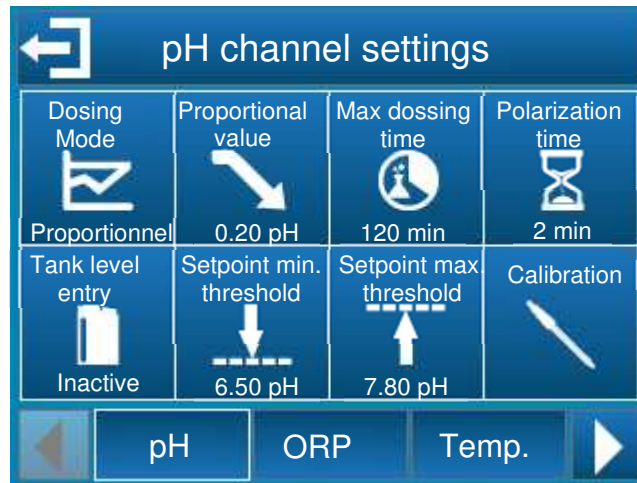

This button allows to select the pH channel control mode (proportional or hysteresis mode).

- The proportional mode is a linear computation, the drive control is based on one component, the Proportional
- The hysteresis mode is an on/off control, the hysteresis value is the gap between the setpoint and the measure value. When the measure value is upper than the highest point the control drives the down actuator. When the measure is lower than the lowest point control drives the up actuator. Between the setpoint and the lowest or highest point, the previous actuator remains active.



When the dosing direction of the pH channel is configured in downstream mode, depending on the control mode previously selected, this button is used to select the value of the proportional band or the hysteresis value.

- In proportional mode, when the error (setpoint – measure) is equal to the proportional band, the control requirement is 100%. Reducing the value of the proportional band, you increase the dosing control for the same measurement value.

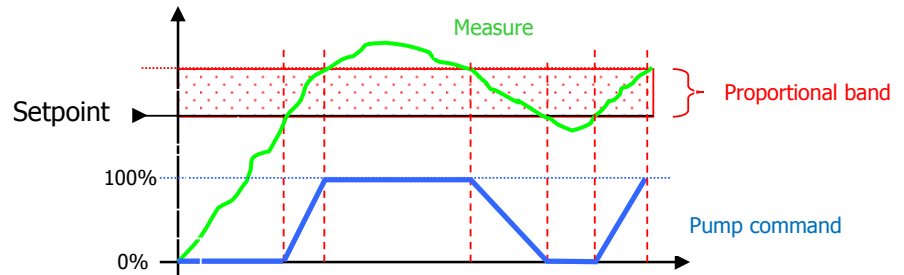

- In Hysteresis mode, when the error (setpoint - measure) is greater than the hysteresis value, the regulation requirement is 100%.

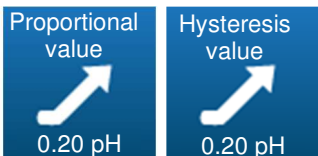
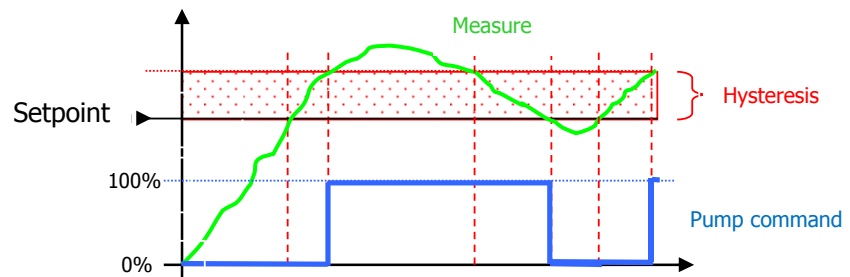

When the dosing direction of the pH channel is configured in upstream mode, depending on the control mode previously selected, this button is used to select the value of the proportional band or the hysteresis value.

- In proportional mode, when the error (setpoint – measure) is equal to the proportional band, the control requirement is 100%. Reducing the value of the proportional band, you increase the dosing control for the same measurement value.

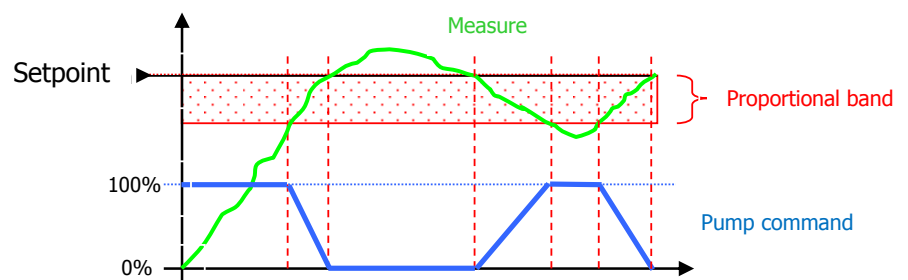

- In Hysteresis mode, when the error (setpoint - measure) is greater than the hysteresis value, the regulation requirement is 100%.

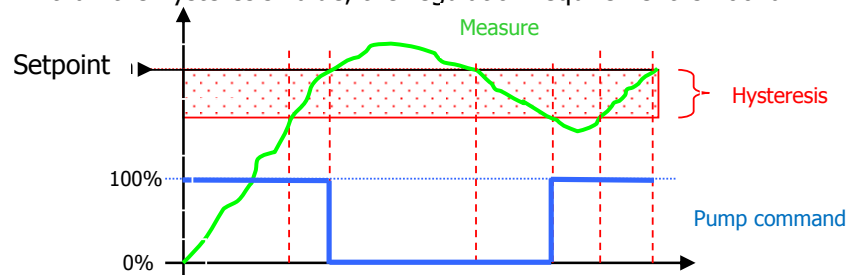



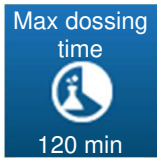

This button is used to enter a maximum time of use of the pump associated with the pH sensor. This max time is configurable between 0 (disable or OFF) and 1440 minutes.  
If the time of use of the pump exceeds this duration, the dosing stops and it will resume only after the intervention of the user who will have to cancel this alarm. During this phase the symbol appears on the main screen



This button is used to enter a start delay for the pH sensor between 0 and 480 seconds.  
This delay is used to delay start-up of the control and alarm processing after starting the device or disconnecting the sensor. During this phase the symbol appears on the main screen



This button is used to active or inactive the "tank level entry". It also allows you to choose the direction of NO or NC contact. When this entry is detected the symbol appears on the main screen



This button is used to set the maximum set point of the pH channel which can be entered in user mode.



This button is used to set the minimum set point of the pH channel which can be entered in user mode.



This button is used to calibrate the pH channel.

5.5.1.2 Calibration

*Cf. chapter 5.6 pH and ORP channel calibration*

The image shows a screenshot of the 'pH calibration' screen with several callout boxes explaining the controls:

- Manual calibration or with a standard:** Points to the 'Manuel' button.
- Allows to know the stability of ythe measure:** Points to the 'Stability' indicator (a green circle with a checkmark).
- Cancel the current calibration:** Points to the 'pH 4' button.
- Enter the value of the standard:** Points to the 'pH 7' button.
- Enter the current calibration:** Points to the 'Enter' button (checkmark icon).
- Clear the calibration and use the factory values:** Points to the 'Clear' button (trash can icon).

The screen itself displays 'pH calibration' at the top, 'Enter the value read on the photometer' below it, and a large '6.93' in the center. At the bottom, there are buttons for 'pH 4', 'pH 7', 'Manuel', 'Stability', '+', '-', 'Clear', 'Cancel', and 'Enter'.

## 5.5.2 ORP channel settings

### 5.5.2.1 Settings

This screen is used to adjust the parameters related to the ORP measurement

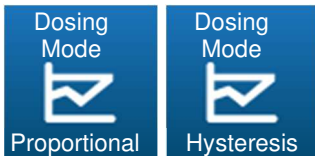
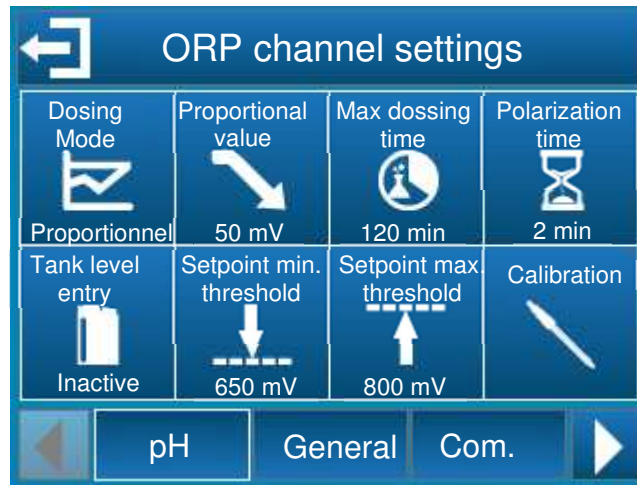

This button allows to select the ORP channel control mode (proportional or hysteresis mode).

- The proportional mode is a linear computation, the drive control is based on one component, the Proportional
- The hysteresis mode is an on/off control, the hysteresis value is the gap between the setpoint and the measure value.
  - When measure value is upper the highest point the control drives the down actuator.
  - When the measure is lower the lowest point control drives the up actuator.
  - Between the setpoint and the lowest or highest point, the previous actuator remains active.

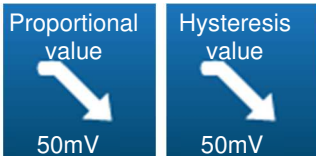

When the dosing direction of the ORP channel is configured in downstream mode, depending on the control mode previously selected, this button is used to select the value of the proportional band or the hysteresis value.

- In proportional mode, when the error (setpoint – measure) is equal to the proportional band, the control requirement is 100%. Reducing the value of the proportional band, you increase the dosing control for the same measurement value.

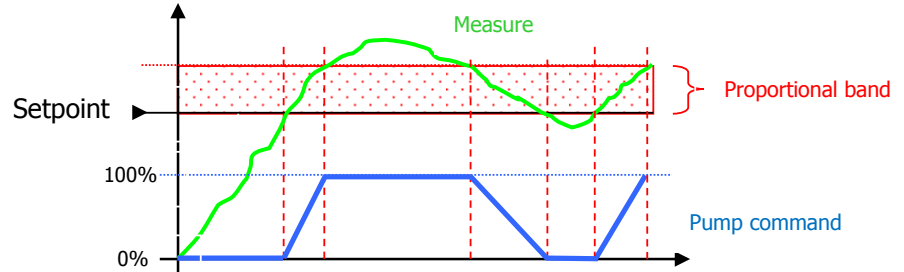

- In Hysteresis mode, when the error (setpoint - measure) is greater than the hysteresis value, the regulation requirement is 100%.

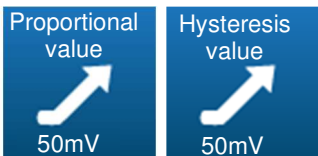
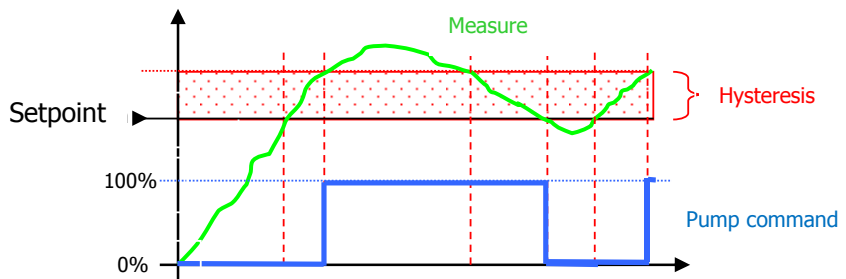

When the dosing direction of the ORP channel is configured in upstream mode, depending on the control mode previously selected, this button is used to select the value of the proportional band or the hysteresis value.

- In proportional mode, when the error (setpoint – measure) is equal to the proportional band, the control requirement is 100%. Reducing the value of the proportional band, you increase the dosing control for the same measurement value.

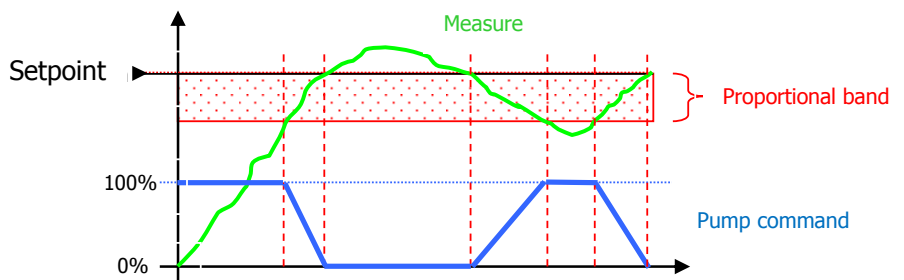

- In Hysteresis mode, when the error (setpoint - measure) is greater than the hysteresis value, the regulation requirement is 100%.

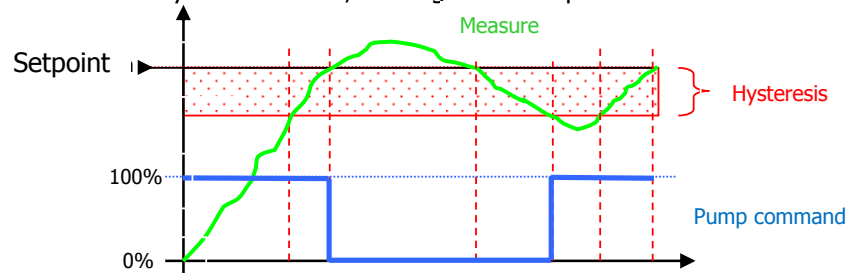

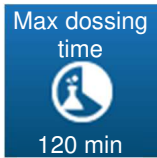

This button is used to enter a maximum time of use of the pump associated with the ORP sensor. This max time is configurable between 0 (disable or OFF) and 1440 minutes.  
If the time of use of the pump exceeds this duration, the dosing stops and it will resume only after the intervention of the user who will have to cancel this alarm. During this phase the symbol appears on the main screen



This button is used to enter a start delay for the ORP sensor between 0 and 480 seconds.  
This delay is used to delay start-up of the control and alarm processing after starting the device or disconnecting the sensor. During this phase the symbol appears on the main screen



This button is used to active or inactive the "tank level entry". It also allows you to choose the direction of NO or NC contact. When this entry is detected the symbol appears on the main screen



This button is used to set the maximum set point of the ORP channel which can be entered in user mode.



This button is used to set the minimum set point of the ORP channel which can be entered in user mode.



This button is used to calibrate the ORP channel.

### 5.5.2.2 Calibration

*Cf. chapter 5.6 pH and ORP channel calibration*

The screenshot shows the "ORP calibration" screen. At the top, it says "Enter the value read on the photometer" with a field containing "465mV". Below this is a large display showing "480". To the right of the display are "Manuel" and "Stability" (with a green circle icon). Below the display are up and down arrow buttons. At the bottom are "Clear" (trash icon), "Cancel" (X icon), and "Enter" (checkmark icon) buttons. Callouts point to these elements:

- Manual calibration or with a standard (points to the 465mV field)
- Allows to know the stability of ythe measure (points to the Stability icon)
- Cancel the current calibration (points to the Cancel button)
- Clear the calibration and use the factory values (points to the Clear button)
- Enter the value of the standard (points to the up/down arrow buttons)
- Enter the current calibration (points to the Enter button)

### 5.5.3 Temperature channel settings

This screen is used to adjust the parameters related to the temperature channel.

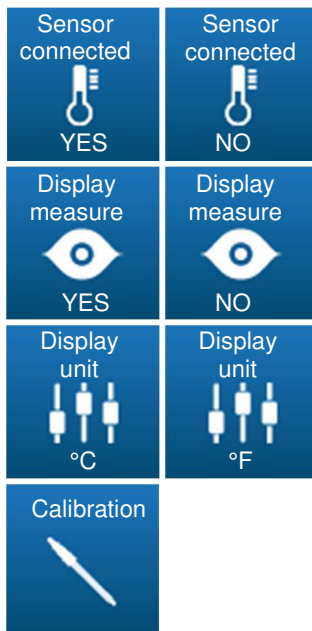
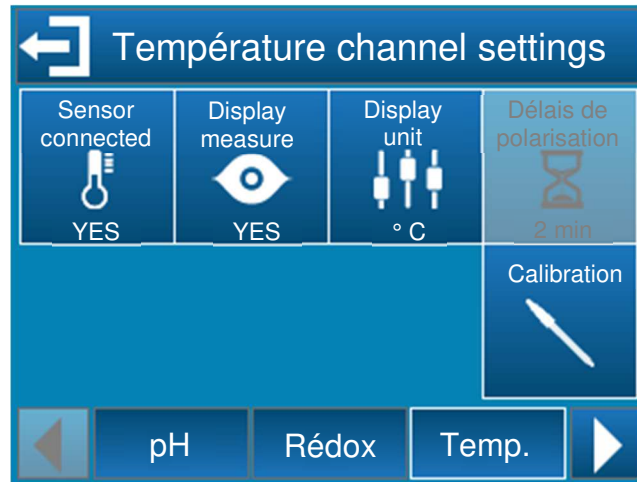

This field is used to enable or disable the temperature measure.

This field is used to enable or disable the display of the temperature value



This field is used to select the unit °C or °F.

This button is used to calibrate the temperature channel.

### 5.5.4 Timers settings

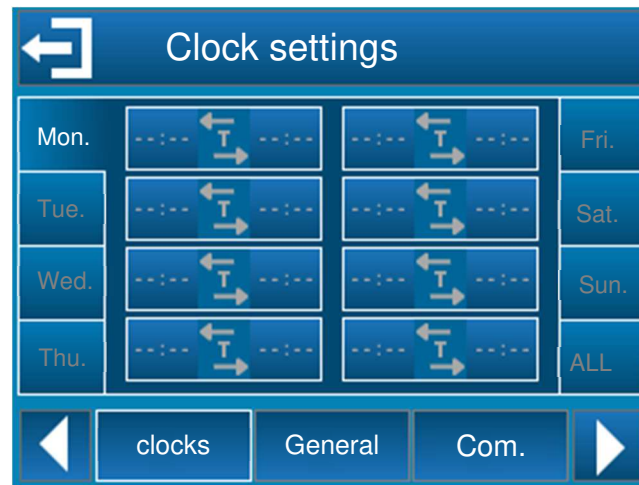
This screen is used to define the relay's operating slots. If a slot is running, a clock symbol  appears in the notification bar.



You can program up to 8 different daily slots for each day of the week (  from to  ) or up to 8 weekly slots (  ).

To enable a slot, you should programme a start time and an end time.



The slot is disable.

The slot have a start slot but it's not active

The slot is enable. Example :Start time is 14h00 and stop time is 16h00.



**NOTE :**

*The minimum slot time is 1 minute.*



**NOTE :**

*The maximum slot time is 24 hours.*

### 5.5.5 General settings

This screen is used to set the parameters of the "remote control" contact, the flow switch contact, the dosing direction for the pH and ORP channels and the pump cycle time associated with the pH and ORP channels.



**CAUTION :**

*The « remote control » and flow switch inputs are designed to connect a free potential.*

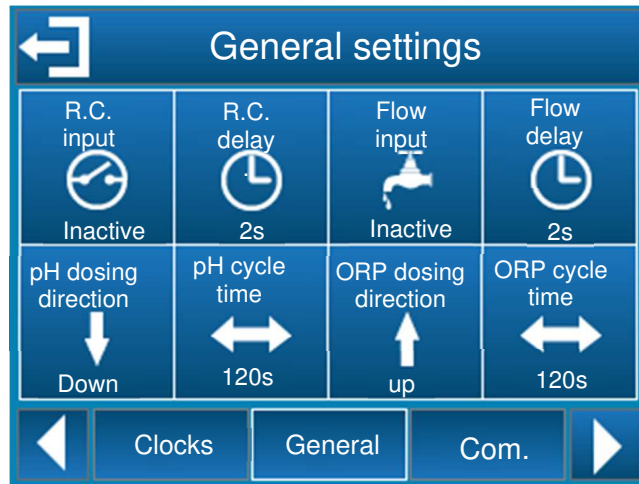

This button is used to enable or disable the "remote contact" entry. It also allows to choose the direction of NO or NC contact

This button is used to enable or disable the "flow switch contact" entry. It also allows to choose the direction of NO or NC contact

This button is used to set the contact's anti-bounce delay.  
This delay can be deactivated when it is set to "OFF".  
This delay can be adjusted up to 240s

This button is used to adjust the dosing direction of the channel.  
This sense of dosage can be "up" or "down".



This button is used to set the cycle time of the dosing pump.  
This time is adjustable from 10 to 1800s

### 5.5.6 Communications settings

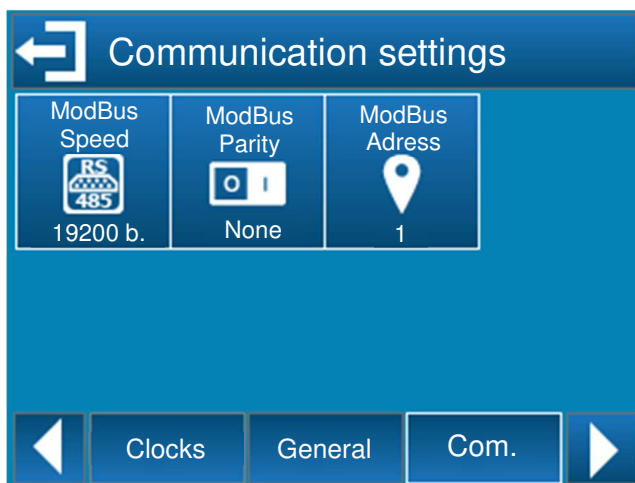
This screen is used to set the communication parameters of the RS485 bus.



You can change the communication speed, the parity and the modbus address (slave id) by selecting each button.

<p><b>Adresse</b></p> 	<p>Slave ID 1...247</p>
<p><b>Vitesse</b></p> 	<p>Baud rate :</p> <ul style="list-style-type: none"> <li>300</li> <li>1200</li> <li>2400</li> <li>4800</li> <li>9600</li> <li>19200</li> <li>38400</li> <li>57600</li> <li>115200</li> </ul>
<p><b>Parité</b></p> 	<p>Parity None, odd, even</p>



### 5.5.7 Advance settings

This screen allows you to adjust advanced device settings.

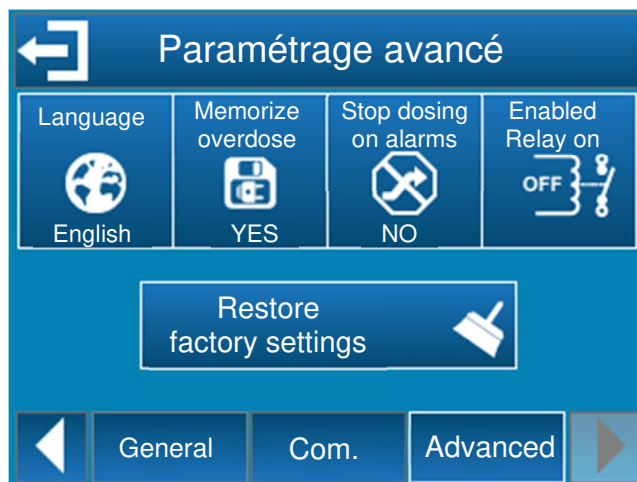

This button is used to set the language of the device.



This button is used to activate or deactivate the backup daily overdose alarm when there is a power failure.

This button is used to activate or deactivate the dosing cutoff when there is a technical alarm on the device (high or low alarms).



This button enable the command n the internal powered relay on timer or alarm

This button resets all the device parameters to the factory settings.



**NOTE :**

*After a reset the device restarts automatically.*



**NOTE :**

*Calibration values are erased so you have to recalibrate all your sensors*

## 5.6 pH and ORP channel calibration

### 5.6.1 Automatic pH and ORP channel calibration (without reagents)



**CAUTION :**

*Automatic calibration of pH or ORP does not use standard fluid!  
Prior to calibration, make the measurement of pH with reference equipment or chemical reagents!*



**NOTE :**

*This operation does not require neither the shutdown of the filtration, nor the exit of the sensors from their holders!*



**NOTE :**

*Chemical reagents for measurement of pH or ORP are not supplied with the controller.  
Usually, your pool specialist has provided you with a colorimetric reagent for measurement of pH of your pool water. Use it and raise the real value of the pool, and compare it to the value displayed. If the value is close to + / - 0.1 pH, do not perform calibration. The uncertainty of your reactive or of your eye is equal to the difference!*

To automatically calibrate the pH or ORP value, just press on the channel to be calibrate and press the button " Calibration" (cf. chapter 5.4.4 Channel settings).

Adjust the value with  or  and confirm with .

#### 5.6.1.1 Automatic pH channel calibration:



**CAUTION :**

*To perform an automatic calibration of pH :*

- *Filtration must operate for several minutes,*
- *The pH value displayed should be stable,*
- *Metering pump must be off,*
- *And the real pH value measured with your reagent or hand-held device must be recent.*

Conditions to perform automatic calibration of pH :

- Sensor must not be faulty or disconnected,
- The pH value displayed must be between 5,5pH and 8,5pH
- Once the calibration is complete, the controller resumes normal operation and displays the pH value changed!

## 5.6.1.2 Automatic ORP channel calibration:

**CAUTION :**

To perform an automatic calibration of ORP :

- Filtration must operate for several minutes,
- The ORP value displayed should be stable,
- Metering pump must be off,
- And the real ORP value measured with your reagent or hand-held device must be recent.

Conditions to perform automatic calibration of ORP :

- Sensor must not be faulty or disconnected,
- The ORP value displayed must be between 200mV and 900mV
- Once the calibration is complete, the controller resumes normal operation and displays the pH value changed!

**5.6.2 Manuel ph and ORP channel calibration (with reagents)****CAUTION :**

The calibration of pH or ORP with standard liquids requires the exit of the sensor to be calibrated from its holder!

**NOTE :**

This operation requires the filtration stop and the setting of a cap to replace the sensor to be calibrated.

**NOTE :**

The standard chemical reagents for calibration of pH / ORP and the cap are not supplied with the controller!

**Step 1**

Stop filtration and close the isolation valves

**Step 2**

Unscrew the « sensor-holder » nut by hand

**Step 3**

Remove the sensor from its housing and remove the seal and the nut from the

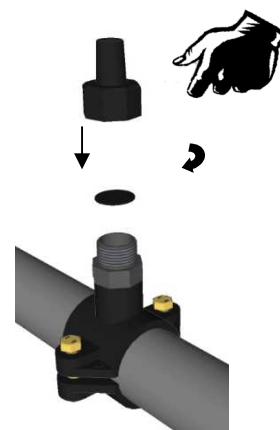
**Step 4**

Put the rubber disk to replace the sensor and screw it all on the « sensor-holder »

### Step 5

Open the valves and turn the filtration ON



### Step 6

Rinse the sensor with clean water without excessive pressure. Expel any dirt.  
Take care not to break or damage the sensitive tip.  
Lay it carefully before calibration.

#### 5.6.2.1 pH 7 calibration :



**CAUTION :**

*To perform a calibration of the pH, it is imperative to start with the standard liquid pH = 7.00.*



**NOTE :**

*For pool, the calibration with pH = 7.00 may be sufficient. After operation, check the pH displayed by the controller is the actual pH of your pool. If it does not match perform the full calibration with pH = 4.00.*

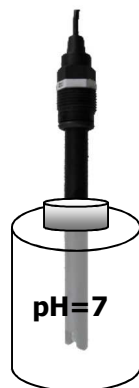

### Step 7

Put the sensor in the standard reagent pH=7.00  
Wait for stabilization of the controller display. When the value is stabilized, perform the following operation

### Step 8

To calibrate the pH 7 value, just press on the channel to be calibrate and press the button " Calibration" (cf. chapter 5.4.4 Channel settings).

Select the pH 7 tab and confirm with .



### Step 9

Rinse the sensor with clean water without excessive pressure before performing the calibration  
pH = 4.00

## 5.6.2.2 pH 4 calibration :

**CAUTION :**

*To perform a calibration of pH 4, it is imperative to start with the calibration of the standard liquid pH=7.00.*

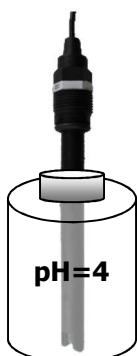
**Step 10**

Put the sensor in the standard reagent pH=4.00  
Wait for stabilization of the controller display. When the value is stabilized, perform the following operation.

**Step 11**

To calibrate the pH 4 value, just press on the channel to be calibrate and press the button " Calibration" (cf. chapter 5.4.4 Channel settings).

Select the pH 4 tab and confirm with .

## 5.6.2.3 465mV ORP calibration:

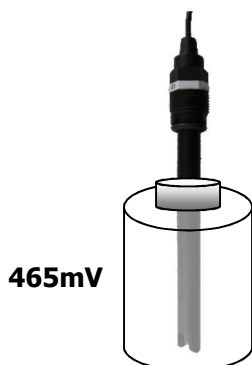
**Etape 12**

Put the probe in the 465mV standard reagent  
Wait for the display to stabilize on the controller.  
When the value is stabilized, proceed to the next operation.

**Etape 13**

To calibrate the 465mV Redox value, simply press the Redox measurement channel and then the calibration button (cf. chapter 5.4.4 Channel settings).

Select the 465mV tab and validate with the .

**Step 14**

Stop ,the filtration and close the isolation gates

**Step 15**

Replace the sensor in its sensor holder.

**Step 16**

Open the gates and turn the filtration on.

**5.6.3 Calibration reset**

To remove calibration value, just press on the channel to be calibrate and press the button " Calibration" (cf. chapter 5.4.4 Channel settings).

Confirm the reset by press the button .

## 5.7 Start of control and dosing

After performing all the previous programming, you are ready to start the control and dosing of the controller.





**WARNING:**

*Before proceeding with the control, please make sure that all the parameters and safety features stated in the documentation have been complied with.*

The On / Off key  is displayed in red when the control is stopped.

The On / Off key  is displayed in green when the control is switched on.

1. Press the key  to start the controller. The ON/OFF key is displayed in green 
2. Check that everything goes well and that the control panel starts to regulate if necessary.

## 6 Maintenance

### 6.1 Maintenance of pH sensor

pH and ORP probes are maintenance free (to be changed). However, the good physical condition of the sensors should be regularly checked

- Check there is no dirt or leaves on the heads of the sensors.
- Carry out their checks by performing calibrations of control.
- Remove them during winter and keep them in original packaging. Do not forget to put water or (better) retention liquid in the sensor cover.



**CAUTION :**

*The sensors should never be left dried in the pool hose.  
If dewatering the lifetime is reduced or terminated*



**CAUTION:**

*Repeated surchlorations or deposits of chemicals can affect the operation or destroy sensors.*



**CAUTION:**

*Flocculation should never be made on direct contact with sensors. If flocculation occurs in a skimmer so continuously, it is recommended to mount the sensors after the filter*

## 6.2 Maintenance of the dosing tubes of the metering pumps

Once the pump tube has cracks or leaks, make the change immediately.

Procedure for changing the tube :



Unscrew the fixing screw of the front cover panel and remove it.



Position the roller holder at 10H20.

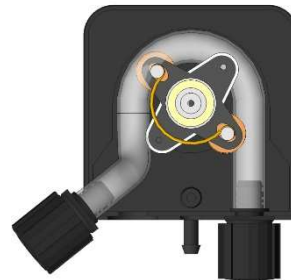

Completely clear the left connection stretching it outwards and then rotate the roller holder to clear the tube.



Position the roller holder at 10H20.

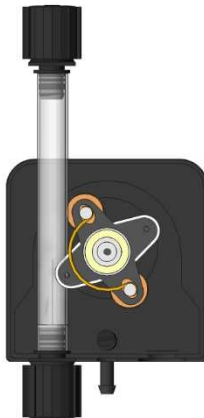

Insert the left connection into its slot, then pass the tube under the roller holder guide. Turn the roller holder, accompanying the tube in the pump head until the right-hand connector.



Show the cap on the pump within the arrows, then tighten the fixing screw of the cover.

## 7 Wintering

**CAUTION :**

*The sensors should never stay dried during the winter in the pool hose.  
Sensors should be kept in a dry place, away from moisture in their original packing.  
A conservation agent is available from your installer. If you forget, put tap water in the sensor cover, and store it in its original packing.  
The lifetime of the sensors depends on the use and conservation.  
In normal use, the duration exceeds three years.  
In case of poor preservation or abnormal use, it can be reduced to a few months!*

*If these precautions are not taken, the sensors will not operate next season.*

**CAUTION:**

*The metering pumps should also be wintered.  
Run clean water into the pumps tubing.  
Disconnect the tubes in case of frost.  
Set the pressure rollers of metering pumps according to the position « 7:05 » by turning the roller holder in the direction of clockwise.  
If these precautions are not observed, the pumps will not operate next season. "Tygon" tube will then be marked and destroyed.*

**CAUTION:**

*Stop pH control by cutting power.  
No special precaution has to be performed.*

**CAUTION:**

*Empty chemicals tanks.*

**NOTE :**

*The chemicals used in pools can be dangerous and corrosive! They can damage your health and cause environmental damage.  
Any mixture of chemicals can be hazardous to health and should never be done!*



## 8 Accessories

Accessories and spare parts for electronic **HYDRO TOUCH** electronic controllers

Designation of the spare part	Code Reference
HYDRO TOUCH pH+ORP controllerwith pumps 0,4l/h 230V/50Hz	<b>CHY 0411</b>
HYDRO TOUCH pH+ORP controllerwith pumps 0,8l/h 230V/50Hz	<b>CHY 0422</b>
HYDRO TOUCH pH+ORP controllerwith pumps 1,6l/h 230V/50Hz	<b>CHY 0433</b>
HYDRO TOUCH pH+ORP controllerwith pumps 2,4l/h 230V/50Hz	<b>CHY 0444</b>
5x20 250mA spare glass fuse HYDRO	<b>FUS5X20T250</b>
5x20 3.5A spare glass fuse HYDRO	<b>FUS5X20R3500</b>
Mounting kit (Screws+ rawplugs)	<b>KFB 0006</b>

pH and ORP sensors **HYDRO TOUCH** controllers.

Designation of the spare part	Code Reference
Standard pH sensor cable 6m	<b>CAA 2524</b>
Sonde de Rédox standard en platine câble 6m	<b>CAA 2522</b>
Sonde de Rédox spéciale « électrolyseur du sel » en or câble 6m	<b>CAA 2521</b>
Standard solution pH=7.00	<b>CAA 2533</b>
Standard solution pH=4.00	<b>SOL 0010</b>
Standard solution ORP=465mV	<b>SOL 0020</b>
pH sensor holder	<b>RAC 1212</b>
External test cap for sensor	<b>SKY 0000</b>

Accessories for metering pumps ...

Designation of the spare part	Code Reference
PE Discharge nozzle (1m) 4x6mm	<b>TPE 0604</b>
Suction pipe in clear PVC (1m) 4x6mm	<b>TPC 0604</b>
Roller-holder for HYDRO Dulco metering pump (0,4 à 2,4l/h)	<b>DF2 9478</b>
Standard « Tygon » tube for all flow rates	<b>DF2 9481</b>
Injection valve for 4/6mm tube	<b>HYD 0001</b>
Suction-rose for 4/6mm tube	<b>HYD 0002</b>
Bottom tank detection kit + external command	<b>ECK 0001</b>
Roll of teflon pipe for waterproofness	<b>TEFLONR</b>

## 9 Failures and remedies



### NOTE :

*In case of malfunction on the external sensors, contact your after sales service.*

Failure	Cause	Remède
The displays do not light up after switching on. No lights are on.	✓ Primary power supply faulty	✓ Check the fuse of the primary power supply. ✓ Check the power cable.
When powering, sensor (s) do not measure (s) or displayed values are crazy.	✓ Cable sensors offline ✓ Faulty sensor	✓ Check the sensor cable ✓ Check the BNC connector ✓ Change the sensor
The sensor shows a maximum value at all times.	✓ Sensor cable cut ✓ Faulty sensor	✓ Check your connections or replace the faulty sensor
Continuing instability of the measurement sensor.	✓ Worn or defective sensor ✓ Presence of air in the filtration ✓ External interference	✓ Change the sensor. ✓ Check the priming of filtration.
Unable to calibrate the sensor.	✓ Poor electrode or unstable measurement	✓ Change the electrode and check the priming of filtration.
Disturbed and unstable control.	✓ Incorrect parameters setting	✓ Check the program settings. ✓ Check the behaviour of the site and adjust the control parameters.
Proportioning devices do not assay.	✓ Controller safekeeping	✓ Check the errors displayed. ✓ Check the operating limit exceeded.

## 10 Maintenance

The controller does not require any specific maintenance.

Repairs may only be performed only by qualified technicians, and must be carried out exclusively at our plant.

If you have any problems with the controller and/or chemical sensors or if you need treatment tips, do not hesitate to contact our after-sales department.

Email : [contact@syclope.fr](mailto:contact@syclope.fr)





**SYCLOPE Electronique S.A.S.**

Z.I. Aéroport Pyrénées  
Rue du Bruscos  
64230 SAUVAGNON - France  
Tel : +33 (0)5 59 33 70 36  
Fax : +33 (0)5 59 33 70 37  
Email : [contact@syclope.fr](mailto:contact@syclope.fr)  
Internet : <http://www.syclope.fr>

© 2018 by SYCLOPE Electronique S.A.S.