



## **Installation and starting instructions**



Parts of the general documentation

- ▶ Part 1: Installation and starting instructions
- Part 2: Programming instructions
- Part 3: Programming communication instructions

**General information:**

**SYCLOPE Electronique 2017**<sup>®</sup> Manual of the 09/01/2017 Rev 1

Professional Analyzers/Controllers for public swimming pools.  
**Product line ALTICE'O**<sup>®</sup>

Part 1: Installation and starting instructions (Ref: DOC0355)

Editor:



**SYCLOPE Electronique S.A.S.**

Z.I. Aéropole pyrénées  
Rue du Bruscos  
64 230 SAUVAGNON - France –  
Tel : (33) 05 59 33 70 36  
Fax : (33) 05 59 33 70 37  
Email : [syclope@syclope.fr](mailto:syclope@syclope.fr)  
Internet : <http://www.syclope.fr>

© 2017 by SYCLOPE Electronique S.A.S.  
Subject to modification

I.	General information .....	5
1)	Applicability .....	5
2)	FCC conformity .....	6
3)	Use of the document .....	7
4)	Symbols and signs.....	7
5)	Storage and transport.....	8
6)	Packaging .....	8
7)	Warranty .....	8
II.	Safety and environmental instructions.....	9
1)	Use of the equipment .....	9
2)	User obligations .....	9
3)	Risk prevention .....	9
4)	Labelling and localization of the identification plate .....	10
5)	Disposal and conformity.....	11
III.	Technical specification and functions .....	12
1)	Technical specifications.....	12
2)	Main functions.....	13
3)	Type and range of measurements .....	14
IV.	Installation and electrical connections .....	16
1)	Installation conditions.....	16
2)	Installation of the wall-mounted devices .....	16
3)	Electrical connections .....	16
4)	Primary electrical connections .....	17
5)	Connecting the power relay outputs free of potential.....	18
6)	Connecting the measurement inputs.....	18
7)	Connecting the power supply to the special measuring cells or converters .....	19
8)	Connecting the analogical outputs .....	19
9)	Connecting remote control inputs (CADx) .....	20
10)	Connecting the flow control inputs.....	20
11)	Connecting the I <sup>+</sup> I <sup>-</sup> bus.....	20
12)	Connecting the printer onto RS232 output .....	21
13)	Connecting the RS485 communication port .....	21
14)	Connecting the internal GSM Modem .....	23
15)	Connecting an external GSM MODEM.....	23
16)	Connecting a WIFI socket modem .....	24
17)	Connecting an Ethernet socket modem .....	24
18)	Connecting the I2C communication port .....	25
V.	General uses .....	26
1)	Sampling on gravity return line .....	26
2)	Sampling between pump and filtering group .....	27
VI.	Automatic configurations.....	28
1)	One circuit for .....	28
2)	Two separated filtration circuits.....	29
VII.	Introduction to the human-machine interface.....	30
1)	Display .....	30
2)	Internal connections .....	31
3)	Connection terminal boards .....	31
VIII.	ALTICE'O® SYCLOPE display mode and display type .....	32
1)	Multi-channel main display .....	32
2)	"Detailed" display of a channel .....	38
3)	Start of control and dosing.....	41
IX.	Commissioning of the SYCLOPE ALTICE'O® .....	42
1)	Choice of automatic configuration .....	42
2)	Programming Date/Time .....	44
3)	Programming setpoints, alarms and calibration .....	45
4)	Programming the graphic historic .....	50
X.	Spare parts and accessories .....	52
XI.	Maintenance.....	52

XII. Appendices : Connections. ....53

## I. General information

### 1) Applicability

The analyser/controller of the **SYCLOPE ALTICE'O®** range you have just purchased is an electronic swimming-pool water management device. It has been carefully developed and manufactured to ensure your greatest pleasure and peace of mind.

Its remarkable capacity for adapting to different conditions and sizes of public swimming pools means it can be installed in the most difficult of environments where control of water treatment and swimming-pool water regulation processes are decisive.

Designed according to the needs of the customer, the **SYCLOPE ALTICE'O®** controller is equipped with 10 analogical inputs, 2 numeric inputs and 2 pulse inputs for specific sensors for treating swimming-pool water and also include alarm functions and regulations with cyclic commands transmitted by means of six configurable internal relays and 2x8 external relays to control temperature, pH, ORP (mV), active, free, total chlorine, chloramines, active, free, total bromine for sea water and DBDMH / BCDMH bromines, cyanuric acid, Ozone, PHMB, Turbidity and conductivity levels. It can combine and calculate 8 parameters with these entries and use them as entire complete parameters.

Two ports, RS232 and RS485, for a printer and/or a computer link, allows communication by direct link or phone modem or GSM/WIFI/Ethernet Modems to a desktop computer (PC) for filing and graphic processing of the acquisition data.

**ALTICOM®** and **SYSCOM®** software applications made by SYCLOPE Electronique S.A.S. have been developed to perform these functions.

The simplicity of operation of the **SYCLOPE ALTICE'O®**, the user friendliness and the remarkable technical aspects of these controllers, will ensure you benefit from their many options, guaranteeing you full control and supervision of the quality of the water in your swimming pool.

The following instructions contain all the information required for the installation, use and maintenance of your new equipment.

- Installation
- Technical specifications
- Commissioning instructions
- Safety tips

If you would like to receive further information or if you encounter any difficulties not described in this manual, please contact your usual retailer or else directly contact the sales department of SYCLOPE Electronique S.A.S., either at the agency or at the office for your region, or the technical/quality departments of our establishments. We will do everything in our power to help you and ensure you benefit from our advice and know-how in the field of measurement and treatment of swimming-pool water.

Contact : [contact@syclope.fr](mailto:contact@syclope.fr)

## 2) FCC conformity

This device complies with Part 15 of the FCC rules. Operation is subject to the following two conditions: (1) This device may not cause harmful interference and (2) this device must accept any interference received including interference that may cause undesired operation.

Instructions to Users: This equipment complies with the requirements of FCC (Federal Communication Commission) equipment provided that the following conditions are met.

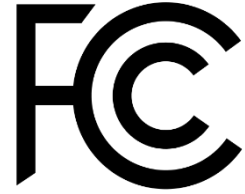

This equipment has been tested and found to comply with the limits for a Class B digital device, pursuant to Part 15 of the FCC Rules. These limits are designed to provide reasonable protection against harmful interference in a residential installation. This equipment generates, uses, and can radiate radio frequency energy and, if not installed and used in accordance with the instructions, may cause harmful interference to radio communications. However, there is no guarantee that interference will not occur in a particular installation.

If this equipment does cause harmful interference to radio or television reception, which can be determined by turning the equipment off and on, the user is encouraged to try to correct the interference by one or more of the following measures:

- Reorient or relocate receiving antenna,
- Increase the separation between the device and receiver,
- Connect the device into an outlet on a circuit different from that to which the receiver is connected,
- Consult the dealer or an experienced radio/TV technician for help.

Changes or modifications not expressly approved by the party responsible for compliance could void the user's authority to operate the equipment.

**Remark:** In order to maintain compliance with the limits of a Class B digital device, use a recommended shielded cable when connected to this device as describe in the present notice. Using a bad cable or a cable not connected to the ground voids the user's authority, which is granted by the Federal Communications Commission, to operate this equipment.

### 3) Use of the document

Please read carefully the entire document before starting the installation and the commissioning of the controller device, in order to ensure the safety of swimmers, users and equipment's.

The information provided in this document must be strictly observed. SYCLOPE Electronique S.A.S. declines all responsibility in cases where failure to comply with the instructions of this documents.

The following symbols and pictograms will be used to facilitate reading and understanding of these instructions.

- Information
- ▶ Action to be taken
- Item of a list or catalogue

### 4) Symbols and signs



Identification of a continuous voltage or current.



Identification of an alternative voltage or current.



Protective ground.



Functional ground.



Risk of injury or accident. Identifies a warning concerning a potentially dangerous risk. The documentation must be consulted by the user with each time the symbol is notified. If the instructions are not respected, this presents risks of death, physical injuries or property damages.



Electric hazard. Identifies a warning statement relative to a mortal electric danger. If the instructions are not strictly respected, this implies an inevitable risk of physical injuries or death.



Risk of incorrect operation or damage for the device.



Comment or particular information.



Recyclable element.

### 5) Storage and transport



It is important to store and to transport the **SYCLOPE ALTICE'O®** controller in its original packaging in order to minimize risk of damage. Furthermore, the package must be stored in an environment that is protected against humidity and exposure to chemical products.

Environmental conditions for transport and storage:

Temperature: -10 °C to 70 °C

Air humidity: Maximum of 90% with no condensation

### 6) Packaging



The controller is delivered without electrical power cable.

The pre-drilled holes of the box are drilled and equipped with according electrical glands in compliance with IP65 level protection. The cables must be adapted to the electrical glands for respecting the level of protection.

Content of the packaging:

- ✓ One analyser/controller **SYCLOPE ALTICE'O®**
- ✓ Installation and starting instruction notice
- ✓ Programming notice
- ✓ Communication notice (Option)

### 7) Warranty

The warranty is provided according to the terms of our general conditions of sale and delivery as long as the following conditions are met:

- Use of the equipment according to the instructions of this notice
- No modifications of the equipment which may modify its behaviour and no incorrect manipulation
- Respect for the electrical safety conditions



Consumable material is no longer covered by the warranty when in use.



## II. Safety and environmental instructions

Please:

- Read this manual carefully before the unpacking, the installing or the commissioning of this equipment
- Take into account all the hazards and of recommended precautionary measures

The failure to respect these procedures can result in serious injury to users or damaging the device.

### 1) Use of the equipment

The **SYCLOPE ALTICE'O**<sup>®</sup> controller has been designed to measure and control temperature, pH, Redox potential, chlorine (or bromine), Ozone, PHMB, flow, Turbidity and Conductivity by means of sensors and controls of suitable actuators in the context of the possible uses described in this manual.



All other uses are considered to be non-conforming and must therefore be forbidden. SYCLOPE Electronique S.A.S. will not be responsible in any case for any damage that result from such uses.

### 2) User obligations

The user undertakes not to allow its employees to work with the **SYCLOPE ALTICE'O**<sup>®</sup> controller described in this manual unless they:

- Are aware of the fundamental instructions relating to work safety and prevention of accidents.
- Are trained in the use of the device and its environment.
- Have read and understood these instructions, warnings and manipulation rules.

### 3) Risk prevention



The installation and connection of the **SYCLOPE ALTICE'O**<sup>®</sup> controller should be only performed by specialized personnel and qualified for this task.  
The installation must comply with the current safety standards and instructions!



Before opening the controller or manipulate the relay outputs, always remember to switch-off the primary power supply!  
Never open the controller when it is powered on!  
Maintenance operations and repairs should be only performed by trained and specialized personnel!



Take care when choosing the location for installing the controller!  
The controller should not be installed in a hazardous environment and should be protected against splashing with water or chemical products. It should be installed in a dry, well-ventilated and isolated location.



Make sure that the chemical sensors used with this controller correspond well to the chemicals used. Refer to the individual technical note of each sensor. Chemistry of water is very complex, in case of doubt, contact immediately our engineering service or your approved installer/reseller.



Chemical sensors are sensitive elements using consumable parts. They must be supervised, maintained and calibrated regularly using specific calibrator systems not-provided with this equipment. In the event of defect, a surplus possible hazard of chemical injections can be noted. In the doubt, a service contract must be taken near your reseller/installer or failing this near our engineering services. Contact your approved installer/reseller or our business service for more information.

4) Labelling and localization of the identification plate

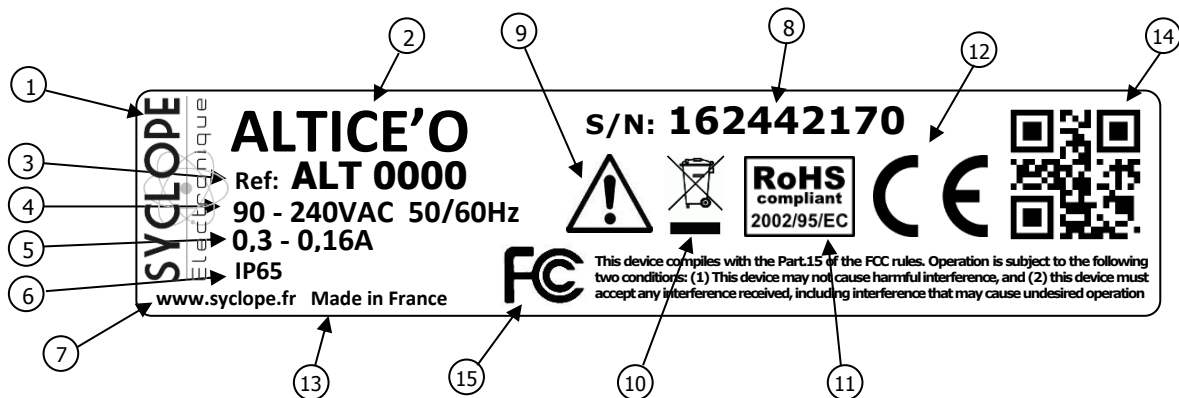

① Label of the manufacturer	⑨ Particular risks. Read the manual
② Model of the product	⑩ Product which can be recycled
③ Reference of the product	⑪ Limitation of dangerous substances
④ Range of power supply	⑫ EC compliance
⑤ Values of the maximum current	⑬ Country of the manufacturer
⑥ Class of protection	⑭ Manufacturer square code
⑦ Identification of the manufacturer	⑮ Conformity with the FCC part 15 Class B
⑧ Serial number	

Identification plate



### 5) Disposal and conformity

The recyclable packaging of the **SYCLOPE ALTICE'O®** equipment must be disposed of according to current regulations.



Elements such as paper, cardboard, plastic or any other recyclable elements must be taken to a suitable sorting center.



According to European directive 2002/96/EC, this symbol means that as of 12 August 2005 electrical appliances cannot be thrown out together with household or industrial waste. According to current regulations, consumers within the European Union are required, as of this date, to return their used devices to the manufacturer, who will take care of disposing them at no extra expense.



Collecting and recycling of the internal batteries: According to the European directive 2006/66/CE, this symbol indicates that until September, 26<sup>th</sup> 2006, used batteries, accumulators and waste materials using dangerous heavy metals as lead (pb), cadmium(Cd) or mercury (Hg) must be collected separately by the manufacturer or by an accredited agency.



According to European directive 2002/95/EC, this symbol means that the **SYCLOPE ALTICE'O®** controller is designed in compliance with the restrictions on hazardous substances.



According to low-voltage directive (2006/95/EC) and the electromagnetic compatibility directive (2004/108/EC), this symbol means that the device has been designed in compliance with the previously cited directives.



In accordance with part 15 of the FCC regulation (Federal communications commission), this symbol indicates that the device was tested and approved under the respect and the conditions of the limits for a Class B digital device.

### III. Technical specification and functions

#### 1) Technical specifications

<b>General characteristics</b>		
Type	Specification(s)	Markers(s)
Consumption	0,3Amp. Max. (90VAC) to 0,16Amp. Max. (240VAC)	-
Power supply requirements	Between 90V to 240V +/-10%	-
Overvoltage Category	Category II	-
Temporary overvoltage	Accept temporary over voltages from power line.	-
Electric protection	Glass 5x20 time-lag 315 mA fuse	F5
Operating temperature (°C)	-5°C to 45°C	-
Storage temperature (°C)	-10°C to 60°C	-
Humidity	Max. 90% without condensation	-
Altitude	Less than 2000m	-
Case material	ABS or Polycarbonate (UL/CSA Version)	-
Case dimensions	Length : 320 mm (12,6 Inches) Width : 260 mm (10,2 Inches) Height : 129 mm (5,1 Inches)	-
Weight of the case	3 kg	-
Protection rating	IP 65	-
Display	LCD 800x465 with backlight	-
<b>Inputs</b>		
Measurement inputs	10x powered analogue 4...20 mA inputs (12V)	E1 to E10
Control or flow inputs	2x programmable pulse inputs in « control On/off » or flow meter function.	CAD1 and CAD2
Numeric entries	2 numerical inputs for Cyanuric Acid sensor	E19 à E20
USB entrie	Front face USB connector	-
<b>Outputs</b>		
Relay outputs	6x relay outputs, free potential dry contact. Max. 5Amp. / 250 VAC	Relay1 to Relay6
Analogue outputs	6x Analogue outputs 0/4...20 mA Max 500 Ω	SA1 to SA6
Printer output	1 RS232 Printer port type	SV3
DC power outputs	2x 12VDC power supply outputs for powering electronic measurement cells. Max 1A together	12V
<b>Communications</b>		
RS485 Bus	1x RS485 communication port	RS485
I <sup>+</sup> I <sup>-</sup> Bus	1x Serial communication port for external displays	I <sup>+</sup> I <sup>-</sup>
I2C Bus	1x I2C serial communication port for external modules	LDA/LCL
Socket Modem (Optional)	1x Socket modem place for phone/WIFI/GSM/Ethernet	Phone line

2) Main functions

<b>Main functions</b>		
Function	Specification(s)	Comment(s)
Regulation mode	On/off, P, PI, PID, Auto configuration	Power outputs for treatment in % Relay cycle time for injection 240s.
Actuator type	Relay outputs - free of potential Analogue outputs 0/4...20mA or 20...0/4mA Impulse drive capability (With internal relays only)	Control with on/off with hysteresis or with cycle width modulation. (CWM) Control from 0 to 100% of programmed scale. Control with PWM from 0 à 120 cps/mn
Direction	Up and/or down function(s)	
Alarms	Low, high and technical alarms	Expressed in real measurement values Control of top and bottom thresholds.
Closed-loop control	Remote control Flow control Level control	Closed-loop control of injections with an external contact (filtering, for example) or with control of water circulation.
Timers	Programming of operating time intervals	Option of 4 different weekly time intervals.
Chemical computations	Chemical computation between selected entries.	8 computing
Configuration	Choice of standard configuration	Auto configuration with standard list
Maintenance	Maintenance helper	Control of dosing actuators
Recording	Data recorder	Data and event tracking
Extension modules	2 x 8 Relay modules 2 x 8 Analogue 0/4...20 mA modules	Driven by I2C bus.

3) Type and range of measurements

<b>Measurements and controls</b>		
<b>Parameters</b>	<b>Measurement ranges</b>	<b>Precision</b>
T°C	-5 to 45°C	± 0,5 %
	0 to 100°C	± 0,5 %
pH	0 to 14 pH	± 0,5 %
	-15,1 to 1 pH	± 0,5 %
Redox (ORP)	0 to 1000 mV	± 0,5 %
	0 to 1500 mV	± 0,5 %
Active chlorine	0 to 1 ppm	± 0,5 %
	0 to 2 ppm	± 0,5 %
	0 to 5 ppm	± 0,5 %
	0 to 10 ppm	± 0,5 %
	0 to 20 ppm	± 0,5 %
Free chlorine	0 to 1 ppm	± 0,5 %
	0 to 2 ppm	± 0,5 %
	0 to 5 ppm	± 0,5 %
	0 to 10 ppm	± 0,5 %
	0 to 20 ppm	± 0,5 %
Total chlorine	0 to 1 ppm	± 0,5 %
	0 to 2 ppm	± 0,5 %
	0 to 5 ppm	± 0,5 %
	0 to 10 ppm	± 0,5 %
	0 to 20 ppm	± 0,5 %
Active bromine	0 to 1 ppm	± 0,5 %
	0 to 2 ppm	± 0,5 %
	0 to 5 ppm	± 0,5 %
	0 to 10 ppm	± 0,5 %
	0 to 20 ppm	± 0,5 %
Free bromine	0 to 1 ppm	± 0,5 %
	0 to 2 ppm	± 0,5 %
	0 to 5 ppm	± 0,5 %
	0 to 10 ppm	± 0,5 %
	0 to 20 ppm	± 0,5 %
BCDMH	0 to 1 ppm	± 0,5 %
	0 to 2 ppm	± 0,5 %
	0 to 5 ppm	± 0,5 %
	0 to 10 ppm	± 0,5 %
	0 to 20 ppm	± 0,5 %
Ozone	0 to 1 ppm	± 0,5 %
	0 to 2 ppm	± 0,5 %
PHMB	0 to 20 ppm	± 0,5 %
	0 to 50 ppm	± 0,5 %
	0 to 100 ppm	± 0,5 %
Cyanuric acid	0 to 100 ppm	± 0,5 %
	0 to 200 ppm	± 0,5 %
	0 to 300 ppm	± 0,5 %
	0 to 500 ppm	± 0,5 %
Conductivity	0 to 1000 µS	± 0,5 %
	0 to 2000 µS	± 0,5 %
	0 to 5000 µS	± 0,5 %
	0 to 1 ms	± 0,5 %
	0 to 100 mS*	± 0,5 %

<b>Measurements and controls</b>		
Salinity	0 to 12 g/l	± 0,5 %
	0 to 32 g/l	± 0,5 %
	0 to 72 g/l	± 0,5 %
Turbidity	0 to 1 NTU	± 0,5 %
	0 to 2 NTU	± 0,5 %
	0 to 5 NTU	± 0,5 %
	0 to 10 NTU	± 0,5 %
	0 to 50 NTU	± 0,5 %
	0 to 100 NTU	± 0,5 %
	0 to 200 NTU	± 0,5 %
	0 to 500 NTU	± 0,5 %
Flow rate ratio	0 to 1000 NTU	± 0,5 %
	0 to 9999 liters/hour	
	0 to 999,9 m <sup>3</sup> /hour	

## IV. Installation and electrical connections

### 1) Installation conditions



To guarantee the user safety and to ensure correct operation of the controller, please observe the following installation instructions:

- Install the controller in a dry location,
- The controller must be protected against rain, frost and direct sunlight,
- The room temperature must range between 0°C and 50°C, with no condensation,
- Choose an installation location free from vibration, on a suitable support and with no deformation.



If these instructions are not observed:

- The controller risks to be damaged,
- The measurements can be disrupted,
- The warranty is not applicable!

### 2) Installation of the wall-mounted devices



Before performing the installation and electrical connections, switch-off the power supply! The rating of IP65 is only guaranteed when the cache of the electric part and the closure of the front face are closed and when the cable glands match to the diameters of the cables and are correctly sealed.

- ▶ Drill three  $\varnothing$  5-mm holes according to the following drilling plan

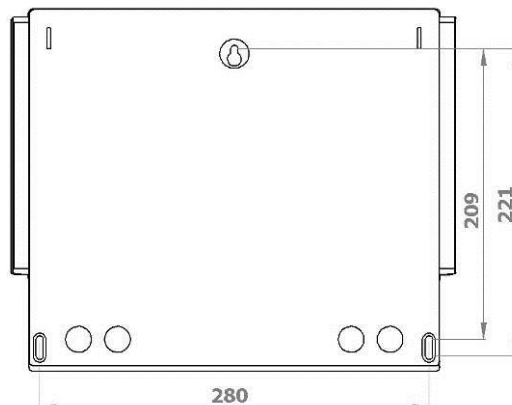

- ▶ Insert the 5-mm plugs using a hammer
- ▶ Insert the upper screw (top screw) first without completely tightening it
- ▶ Insert the lower screws and tighten them
- ▶ Tighten the upper screw
- ▶ Use a spirit level to check for correct and accurate fixing to the wall.

### 3) Electrical connections



The electrical installation must be performed in accordance with current rules by authorized personnel!

A 30mA differential circuit must be installed!

A circuit-breaker of maximum 10 Amp must be installed near the controller and easily accessible to stop the main power. It must be identified as a circuit-breaker for the controller! Before performing the connections, remember to turn off the power!





Use core cables if possible!  
If not possible, always use a special wiring tip to be sure that the wires do not make a contact together!  
Protect the wirings by using electrical clamps.



The controller must be connected to the main recirculation pump by means of the "remote control" input (CAD) to disallow functionality in the case of the main pump being stopped.

#### a) Internal protection

The controller is protected by a 5x20 315mA time-lag glass fuse and by a varistor against voltage surges of 275 V.

Reference	Name
FUS5X20T315	5x20 315 mA time-lag glass fuse



In the event of the fuse blown, check that the card is not burnt out. If this is the case, the complete card must be changed!  
In the event of destruction of the varistor, please return the controller to our technical department for assessment!

#### 4) Primary electrical connections



The **SYCLOPE ALTICE'O**<sup>®</sup> controller uses an internal switching power module. This particularity can be used with a power line of 90 to 250V 5/60Hz without any disturbance.

- ▶ Use a 3-points 1.5 mm<sup>2</sup> cable to wire the power supply. Ground cable must be connected firstly
- ▶ Strip the 3 wires for 7 mm.
- ▶ Pass the 3-point cable through a cable gland.
- ▶ Wire the live to 1 and the neutral to 2 of the sector terminal block B1.
- ▶ Wire the earth to screw contact with the help of an M4 eyelet terminal.
- ▶ Tighten the cable gland to ensure tightness.

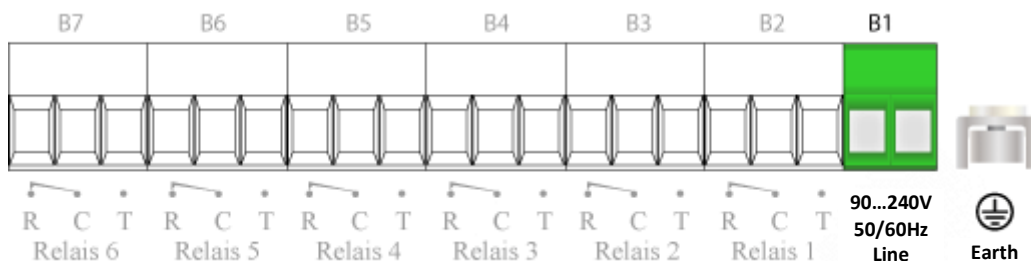

The controller does not have its own independent power switch. It is directly powered when connected to the mains.

5) Connecting the power relay outputs free of potential

The power relay outputs, free of potential, are used to control the various measured or computed parameters. Relays OUT1 to OUT6 are fully programmable (On/off function, width modulation, pulse modulation or 3 points actuation) with all parameters using by the controller.

In case of use the automatic configuration, all power relays will be affected to a specific function (see table automatic configuration Chap VI.).

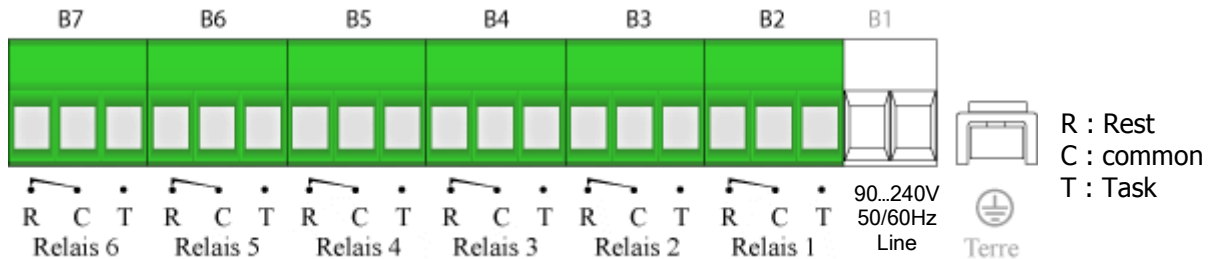

6) Connecting the measurement inputs

The analogue inputs are used for acquiring multiple measurement sensors or special measuring cells using the 4...20mA loop technology.



The measurement entries of the controller are self-powered (12V) and must never be used with an external power supply!



The entries of the controller are not insulated between them!  
 You must use unconditionally the appropriate special measuring cells or converters to be sure that each connected sensor works properly.  
 Warranty repairs will not be accepted in the event of failing to observe these instructions!



Please, respect the polarities when connecting all the wires of the external measuring cells or of the converters onto the controller inputs. The external power supply (12V DC) needed is given by the controller on "+12V" outputs.

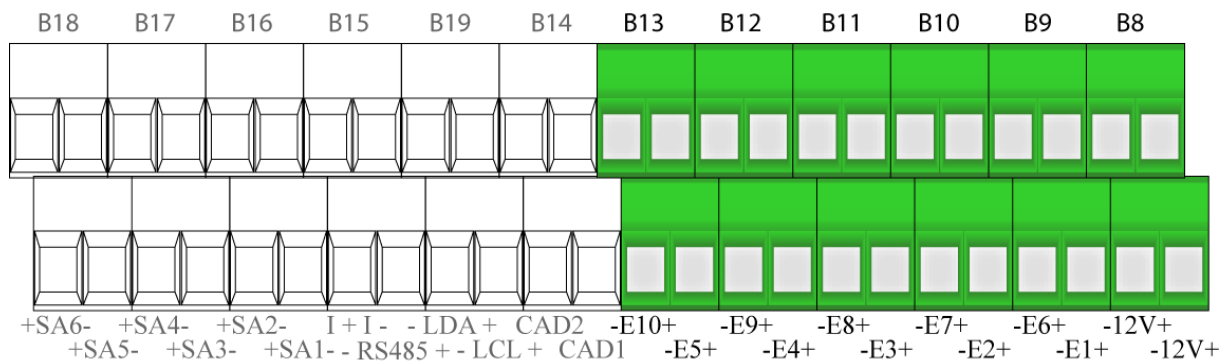

Special case when connecting a sensor with an active analog output (powered) :



- + of the active output (sensor) ⇔ - of the input (-Ex+)
- of the active output (sensor) ⇔ - of the power (-12V+)

Exemple beside with E6 input

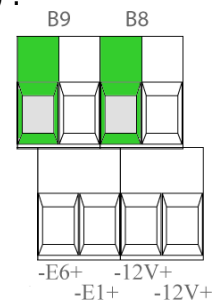

When using the automatic configuration option of the controller, all the corresponding inputs are defined according to the "Factory" setting.

7) Connecting the power supply to the special measuring cells or converters

To work properly, all special measuring cells or all special converters of SYCLOPE products must be powered by the +12VDC output generated by the controller.



Do not invert the power supply polarity!

- Red wire on the +
- Brown wire on the -

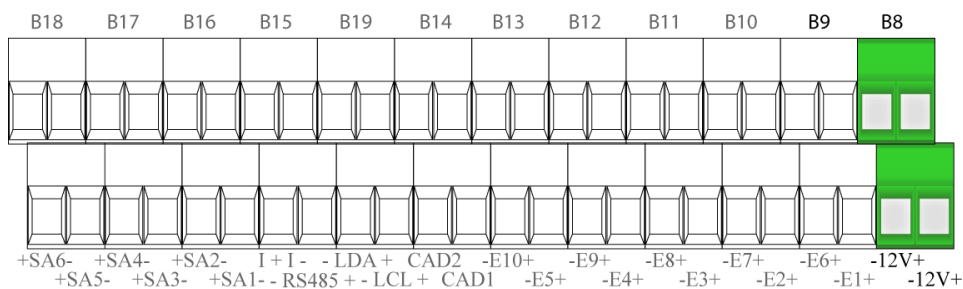

8) Connecting the analogical outputs

The analogue outputs of the controller are used to forward information to a central unit or to control a dosing unit by means of a signal of 0/4 - 20mA or 20...0/4mA.

The analogue outputs of the controller are fully configurable. Therefore, you can assign an output to any measured or calculated parameter and you can use it for control or transfer operations.

If you use the automatic configuration menu, all the analogical outputs will be defined according to the "Factory" setting.

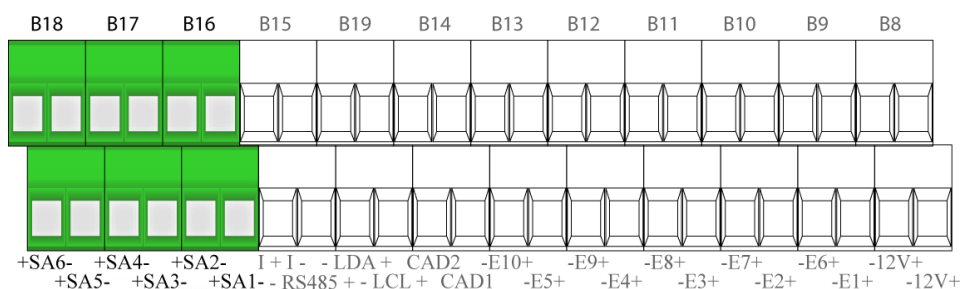

9) Connecting remote control inputs (CADx)

The **SYCLOPE ALTICE'O®** controller has two remote control inputs (CAD1 and CAD2) which stops the dosing units. These inputs are either an open/closed contact input or a pulse control input used in a subservient manner to the main circulation pump of the filtration system.



It is imperative to enslave the controller to the switch of the filtering group's motor to prevent damages caused by chemical overdoses!



The remote-control inputs CAD1 and CAD2 are designed to receive a NO contact (normally open), a NC (normally connected) or a pulse control drive (Open collector or free-potential switch).

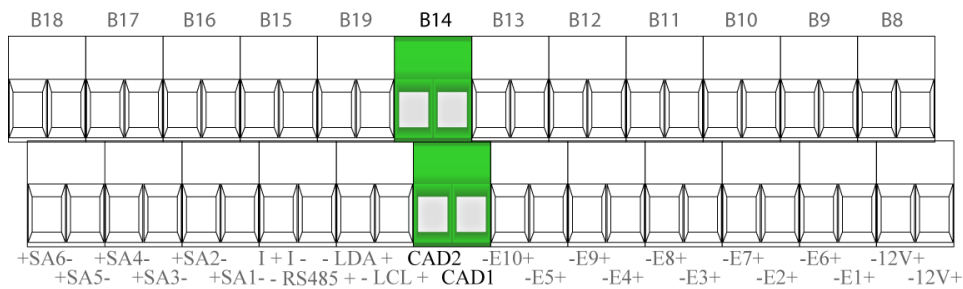

10) Connecting the flow control inputs

The **SYCLOPE ALTICE'O®** controller has 10 programmable analogue inputs where each of them can be programmed as a flow control input (FCI) used to check the presence of circulating water in the measurement cells. This input is designed to receive either an analogue level sensor (4...20mA), either a flow switch control.

- Opened switch : Detection activated by open contact (Normally opened)
- Closed switch : Detection activated by closed contact (Normally closed)
- Analogue : Detection realized by 4-20 mA current loop.



The electronic flow-switches made by SYCLOPE Electronique S.A.S. are especially designed for universal measuring cells or for gravity measuring cells. These detectors are sold as optionals for all measuring cells. They must be ordered separately for the corresponding cell.

Reference	Name
DEB0000	Flow detector for universal measuring cells
DCC0002	Flow detector for gravity measuring cell 1" M (Kit)

11) Connecting the I+I bus

The **SYCLOPE ALTICE'O®** controller has a serial communication bus named "I+I-" for viewing programmed parameters on special external displays. These displays are sold separately and can be used as a remote device of the selected parameters. The distance can be up to 500m. Eight remote displays can be used on the same bus with different address.

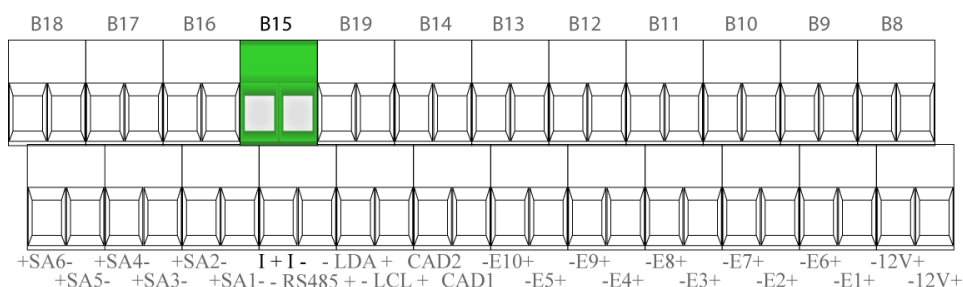



Please, take care to the polarity of each remote display.

- White wire on the I+
- Blue wire on the I-



Reference	Name
DEA0003	Remote display for Temperature, pH and chlorine
DEA0004	Remote display for Temperature, pH ad bromine
DEA0023	Remote display for pH, Chlorine1 and chlorine 2 (DUAL version)

12) Connecting the printer onto RS232 output

The controller has a serial-compatible RS232C output (speed: 4800 bauds) for printing paper reports, guaranteeing surveillance of your measurements and editing the operating log of the machine. To connect a printer to the RS232 port of the controller, you must order a compatible cable. The printer must be a standard printer with compatible ASCII code.

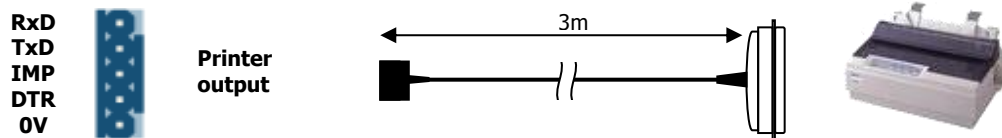

Reference	Name
IMP0080	Serial printer 80 caract.
CBI0000	Printer cable 5pts/DB25M Length 3m

13) Connecting the RS485 communication port

The **SYCLOPE ALTICE'O**® controller has an RS485/RS422 communication port for linking a desktop computer equipped with the data-processing software **SYSCOM**® which trace measurements, alarms, instructions and display graphics or with the maintenance software **ALTICOM**® which can program the controller in real time.

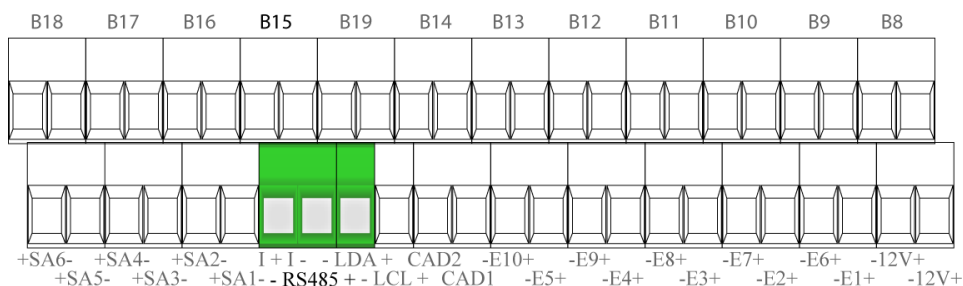

Please, contact us for further information on these products.



Respect the connection polarities of the bus.

- + of the terminal block on signal AA' (no. 3) of the USB/485 converter.
- - of the terminal block on signal BB' (no. 4) of the USB/485 converter.
- - (LCL) of the terminal block on GND (n°5) of the USB/RS485 converter.

a) Connection to USB port of the computer

We suggest using a USB/RS485 interface module to connect the **SYCLOPE ALTICE'O**® controller to your computer. Please consult the instructions of this converter for the connection.

Reference	Name
INF1021	USB => 485 Converter

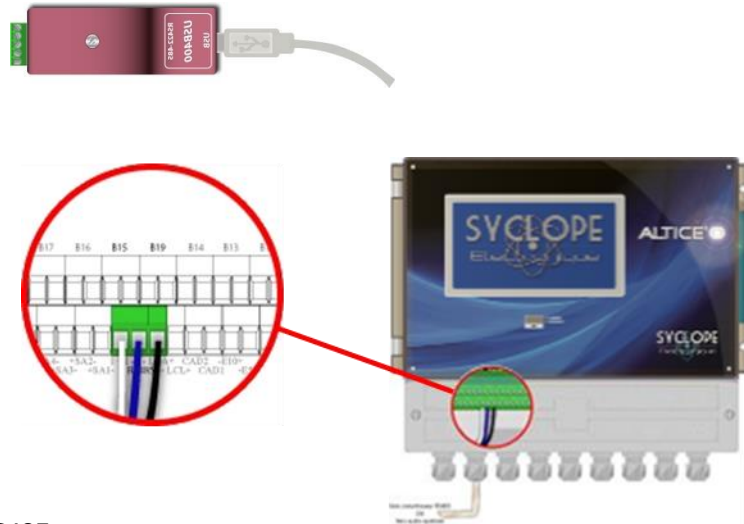

- White: BB' + RS485
- Blue: AA' - RS485
- Black: Ground -LCL



The controllers can be chained by respecting the order of the cables (putting in parallel).



- Blue (Terminal block n°3): AA' RS485
- White (Terminal block n°4): BB' RS485
- Black (Terminal block n°5): Ground RS485



Configuration: All switches are **"ON"**

a) Full connections with PLC using RS485 port



14) Connecting the internal GSM Modem

The controller has an internal location to connect the GSM socket Modem to establish a remote link with the web site [www.mysyclope.com](http://www.mysyclope.com).

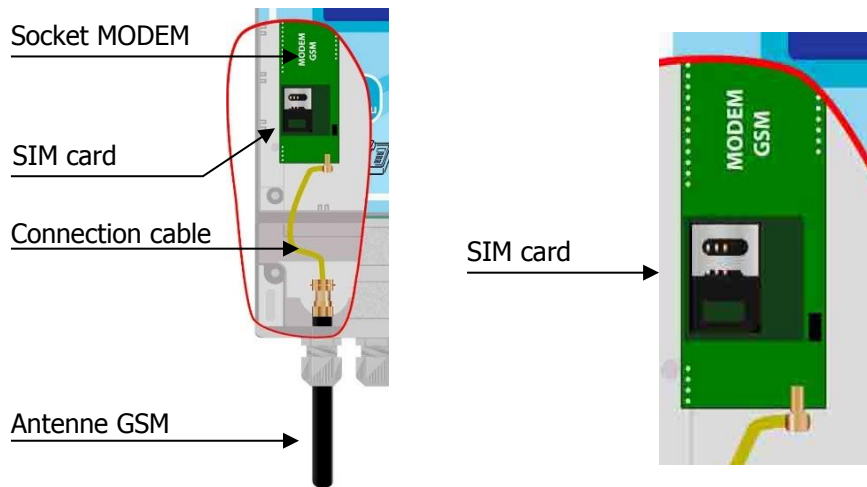

Reference	Name
KMD0020	Internal GSM Modem kit with cable and local antenna

15) Connecting an external GSM MODEM

The controller has an internal location to connect the GSM socket Modem to establish a remote link with the web site [www.mysyclope.com](http://www.mysyclope.com).

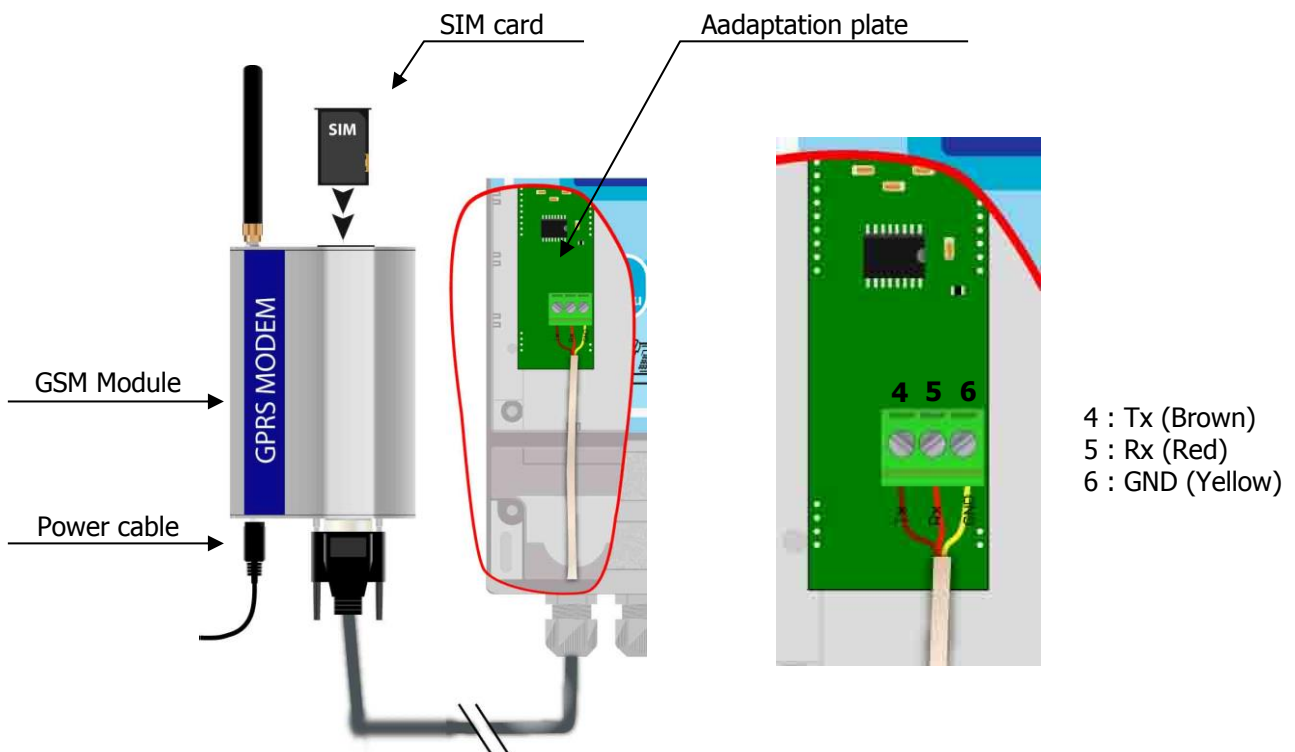

Reference	Name
KMD0030	External GSM Modem kit with cable and adaptation plate



16) Connecting a WIFI socket modem

The controller has an internal location to connect the GSM socket Modem to establish a remote link with the web site [www.mysyclope.com](http://www.mysyclope.com).

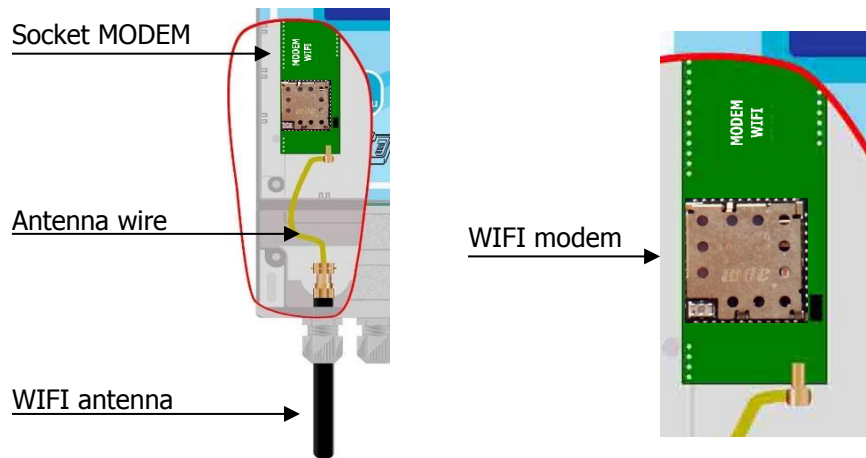

Reference	Name
KMD0050	Socket MODEM WIFI kit with cable and local antenna

17) Connecting an Ethernet socket modem

The controller has an internal location to connect the GSM socket Modem to establish a remote link with the web site [www.mysyclope.com](http://www.mysyclope.com).

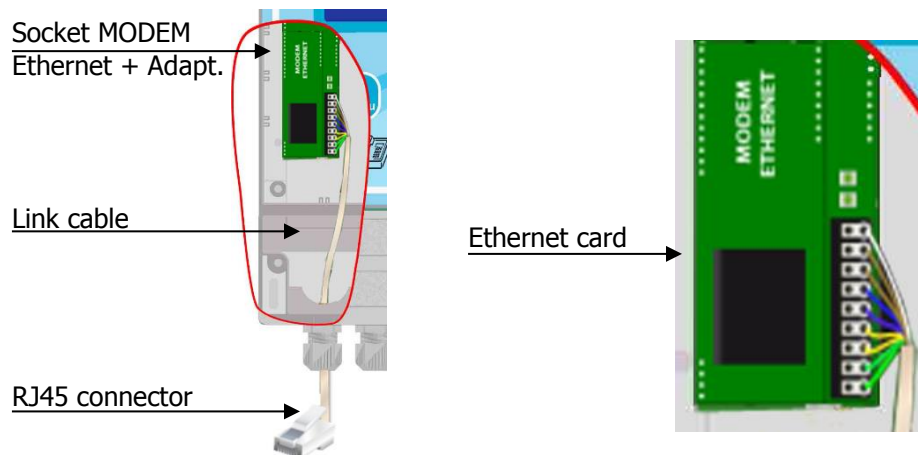

Reference	Name
KMD0040	Ethernet Socket MODEM kit with adaptation card



18) Connecting the I2C communication port

The controller has a compatible I2C output for connecting external extensions to establish a remote link with special modules using relays or 0/4...20mA. The internal software of the **SYCLOPE ALTICE'O®** controller can drive up to 2 modules of 8 relays and 2 modules of 8 0/4...20mA analogue outputs.

a) Internal connections of I2C bus

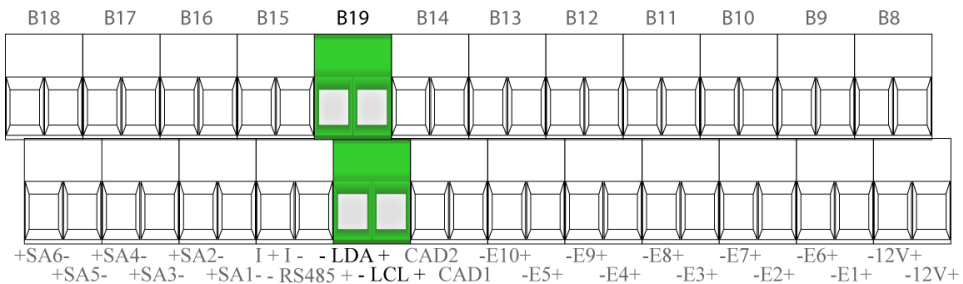

b) External connections of analogical and relays modules

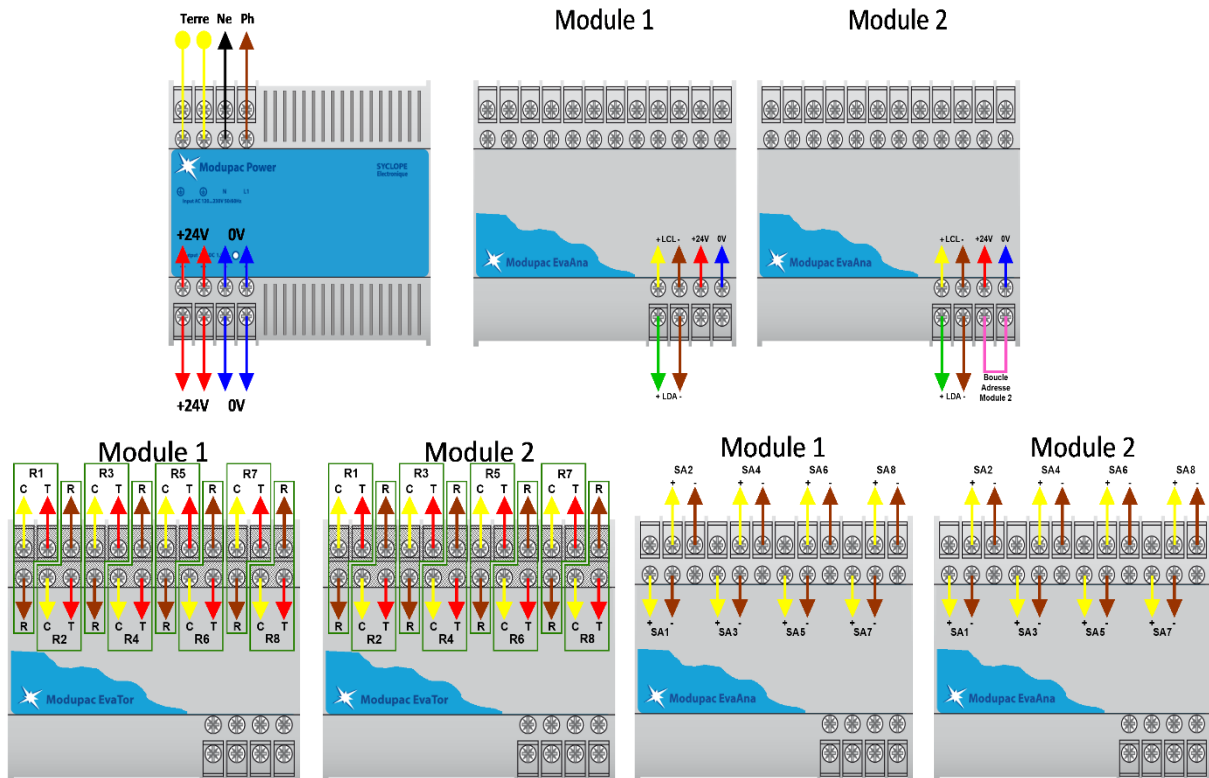

## V. General uses

The **SYCLOPE ALTICE'O**® controller has been designed for measuring, regulating and treating the water in public swimming pools. The controller must be installed on the swimming-pool filtering circuits as shown in the two following diagrams

### 1) Sampling on gravity return line



This type of recirculating circuits is used when you have over one swimming pool with only one filtering group.

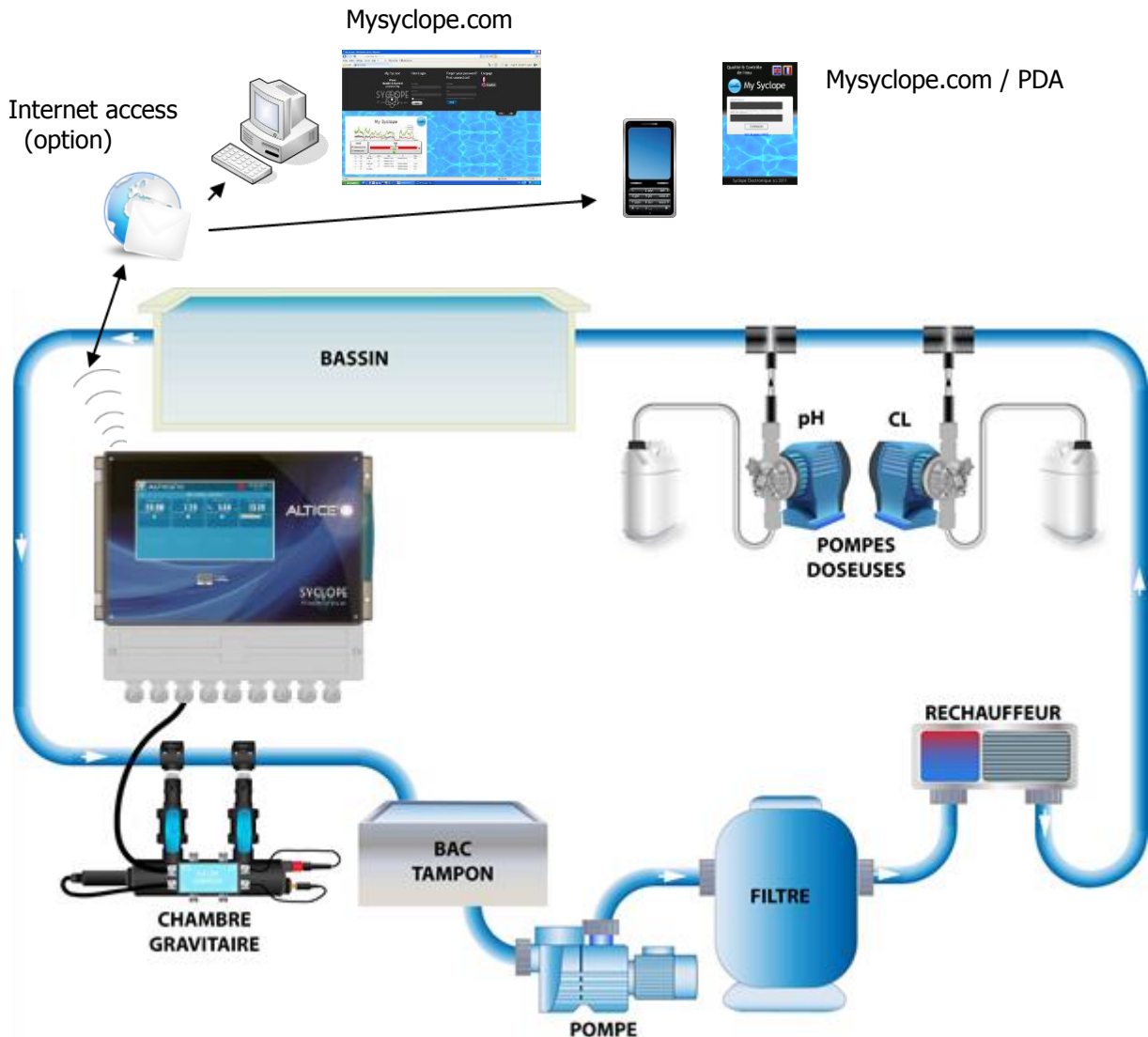

- The water to be measured, is sampled into the gravity measuring cell which is installed on the return line of the swimming pool.
- The measuring cell, equipped with the chemicals sensors, translates the informations into 0/4...20mA current loop signals to the controller.
- According to the programmed setting points, the controller drives each dosing device according to the measured values.



Envisage a maximum distance between the injection points and the measuring point so that the injected chemical products are perfectly homogeneous!

2) Sampling between pump and filtering group

Generally, this type of recirculating circuit is recommended when only one filtering group is used or when each group is separated. However, you can use only one **SYCLOPE ALTICE'O®** controller to control up to 8 filtering groups or circuits.

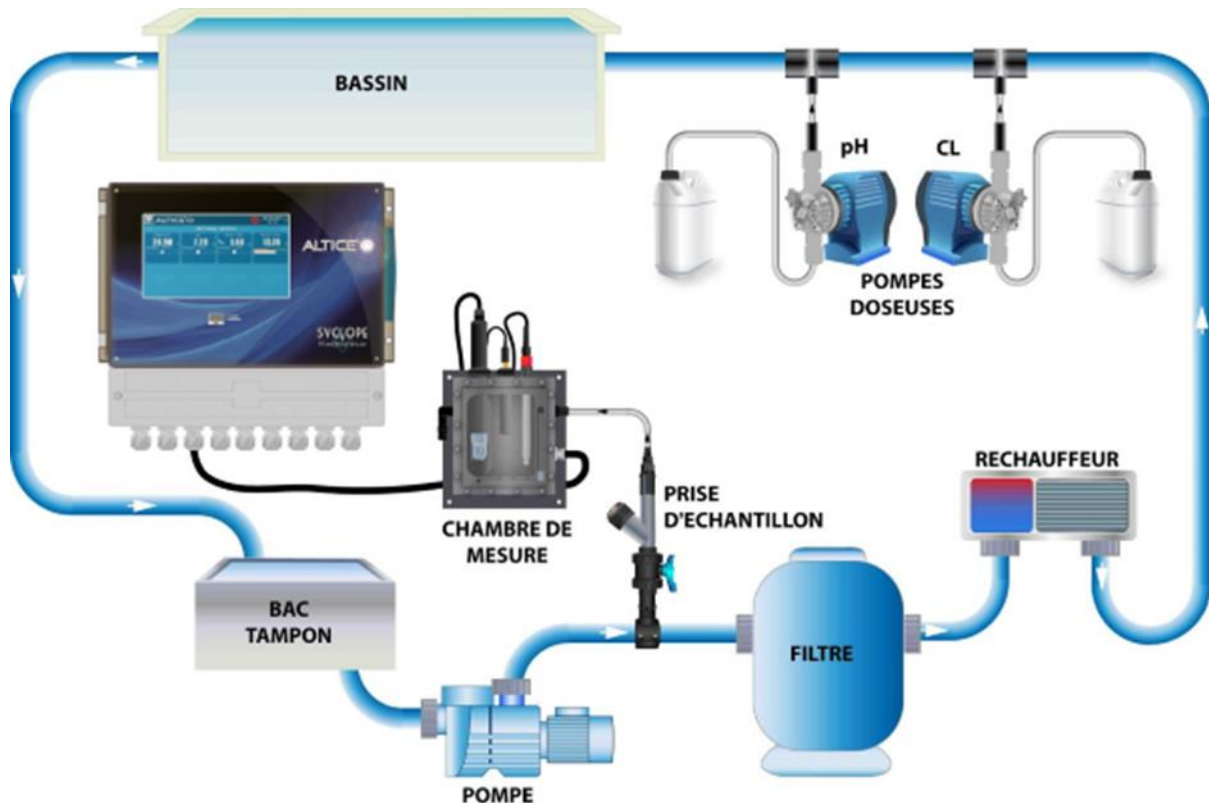

- The water to be measured, is sampled between the recirculating pump and the filter.
- The measuring cell, equipped with the chemicals sensors, translates the information's into 0/4...20mA current loop signals to the controller.
- According to the programmed setting points, the controller drives each dosing device according to the measured values.

## VI. Automatic configurations

Although the **SYCLOPE ALTICE'O**® programming is fairly simple and intuitive, we have integrated into the machine an automatic configurations menu that will give comfort during the commissioning and will save time.

You will find in the following tables, all configurations automatically preset as well as the assignment of the inputs and outputs and their wiring.

### 1) One circuit for

Type	Entries	Ranges	Wirings		Relays	Mode	Analogue outputs	CAD
			+	-				
<b>Factory N°1</b>	E1 : T°C E2 : pH E4 : Free chlorine	-5 à 45 0 à 14 0 à 10	White / Yellow Green White	White / Blue Blue Black	Relay1 : pH Relay2 : Free chorine	Control	NP	CAD1: NO
<b>Factory N°2</b>	E1 : T°C E2 : pH E3 : ORP E4 : Free chlorine	-5 à 45 0 à 14 0 à 1000 0 à 10	White / Yellow Green Yellow White	White / Blue Blue Orange Black	Relay1 : pH Relay2 : Free chorine	Control	NP	CAD1: NO
<b>Factory N°3</b>	E1 : T°C E2 : pH E4 : Free chlorine 1 E6 : Free chlorine 2	-5 à 45 0 à 14 0 à 10 0 à 10	White / Yellow Green White White	White / Blue Blue Black Black	Relay1 : pH Relay2 : Free chlorine Relay3 : Free chlorine	Control	NP	CAD1 : NO
<b>Factory N°4</b>	E1 : T°C E2 : pH E4 : Free chlorine E5 : Total chlorine E11 : Combi Cl. (CC**)	-5 à 45 0 à 14 0 à 10 0 à 10 0 à 10	White / Yellow Green White White -	White / Blue Blue Black Black -	Relay1 : pH Relay2 : Free chlorine Relay3 : Combi. Cl.	Control	NP	CAD1 : NO

\*NP : not programmed

\*\*CC : Chemical computing



**All measuring cells and converters are powered with 12V DC on B8 terminal (-12V+)**

**Colors: (-) Brown (+) Red**

2) Two separated filtration circuits

Type	Entries	Ranges	Wirings		Relays	Mode	Analogue outputs	CAD
			+	-				
<b>Factory N°5</b>	E1 : T°C E2 : pH E4 : Free chlorine E6 : T°C E7 : pH E9 : Free chlorine	-5 à 45 0 à 14 0 à 10 -5 à 45 0 à 14 0 à 10	White / Yellow Green White White / Yellow Green White	White / Blue Blue Black White / Blue Blue Black	Relay1 : pH Relay2 : Free chlorine  Relay4 : pH Relay5 : Free chlorine	Control	NP	CAD1: NF CAD2: NF
<b>Factory N°6</b>	E1 : T°C E2 : pH E3 : ORP E4 : Free chlorine E6 : T°C E7 : pH E8 : ORP E9 : Free chlorine	-5 à 45 0 à 14 0 à 1000 0 à 10 -5 à 45 0 à 14 0 à 1000 0 à 10	White / Yellow Green Yellow White White / Yellow Green Yellow White	White / Blue Blue Orange Black White / Blue Blue Orange Black	Relay1 : pH  Relay2 : Free chlorine  Relay4 : pH  Relay5 : Free chlorine	Control	NP	CAD1: NF CAD2: NF
<b>Factory N°7</b>	E1 : T°C E2 : pH E3 : Free chlorine E4 : Free chlorine E6 : T°C E7 : pH E8 : Free chlorine E9 : Free chlorine	-5 à 45 0 à 14 0 à 10 0 à 10 -5 à 45 0 à 14 0 à 10 0 à 10	White / Yellow Green White White White / Yellow Green White White	White / Blue Blue Black Black White / Blue Blue Black Black	Relay1 : pH Relay2 : Free chlorine Relay3 : Free chlorine  Relay4 : pH Relay5 : Free chlorine Relay6 : Free chlorine	Control	NP	CAD1: NF CAD2: NF
<b>Factory N°8</b>	E1 : T°C E2 : pH E4 : Free chlorine E5 : Total chlorine E11 : Combi Cl. (CC**)  E6 : T°C E7 : pH E9 : Free chlorine E10 : Total chlorine E12 : Combi. Cl (CC**)	-5 à 45 0 à 14 0 à 10 0 à 10 0 à 10  -5 à 45 0 à 14 0 à 10 0 à 10 0 à 10	White / Yellow Green White White - - - White / Yellow Green White White - -	White / Blue Blue Black Black - - - White / Blue Blue Black Black - -	Relay1 : pH Relay2 : Free chlorine  Relay3 : Combined. Cl  Relay4 : pH Relay5 : Free chlorine  Relay6 : Combined Cl	Control	NP	CAD1: NF CAD2: NF

\*NP : not programmed

\*\*CC : Chemical computing



**All measuring cells and converters are powered with 12V DC on B8 terminal (-12V+)**

**Colors: (-) Brown (+) Red**

## VII. Introduction to the human-machine interface

### 1) Display

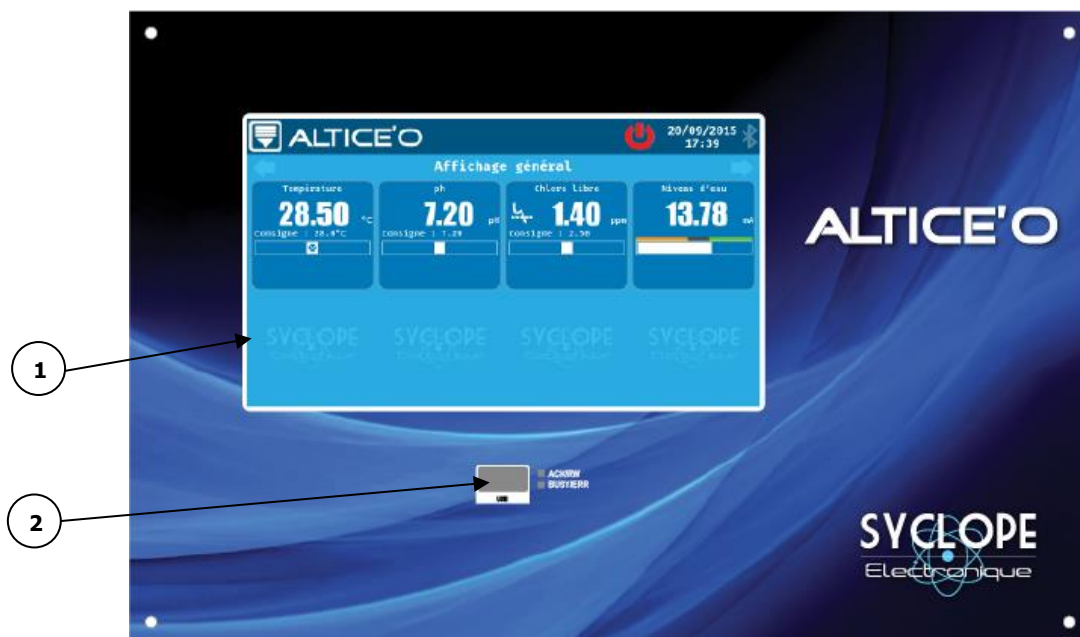

1 Color screen 800x480 7 " Tactile

2 USB Key



The **SYCLOPE ALTICE'O®** controller does not have control keys, the programming and navigation of the menus is carried out by pressing the screen.

2) Internal connections

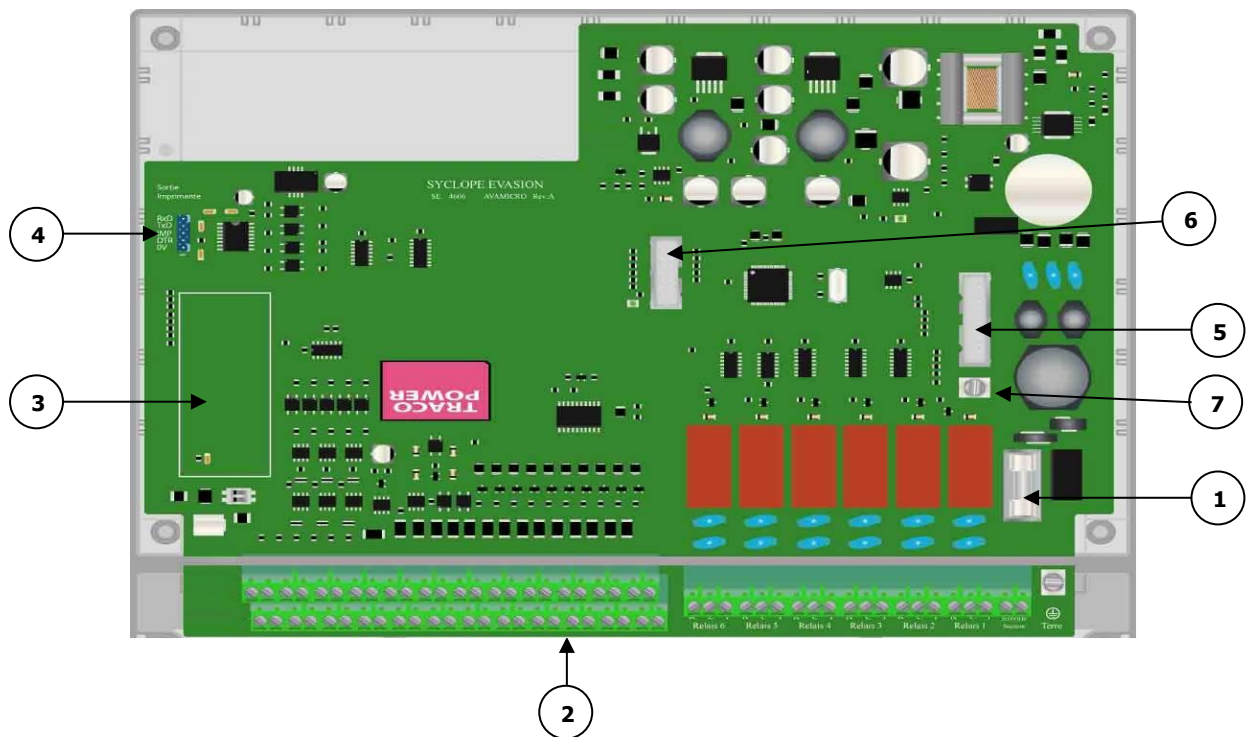

- 1 General protection fuse (glass 5x20 315 mA time-lag fuse)
- 2 Connection terminal blocks (see diagram at the bottom of the page)
- 3 Location for WIFI/GSM/Ethernet socket modem (optional)
- 4 Printer connector port
- 5 Front face Connector 1
- 6 Front face Connector 2
- 7 Ground terminal M4x6 screw with anti-loosening washer

3) Connection terminal boards

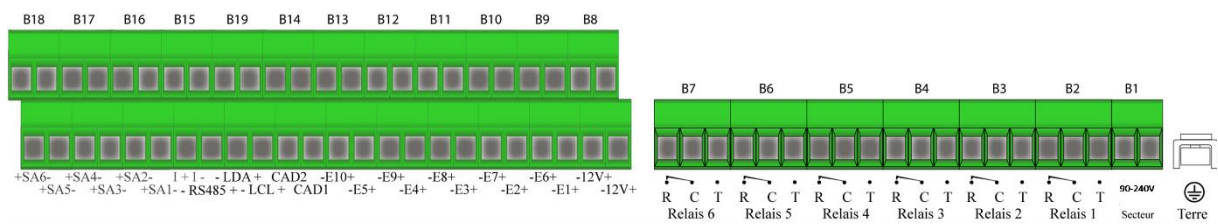



### VIII. ALTICE'O® SYCLOPE display mode and display type

#### 1) Multi-channel main display

The **SYCLOPE ALTICE'O®** system offers several modes and several types of displays that will allow you to instantly have all the information you need.

#### a) "Small thumbnail" channel display modes

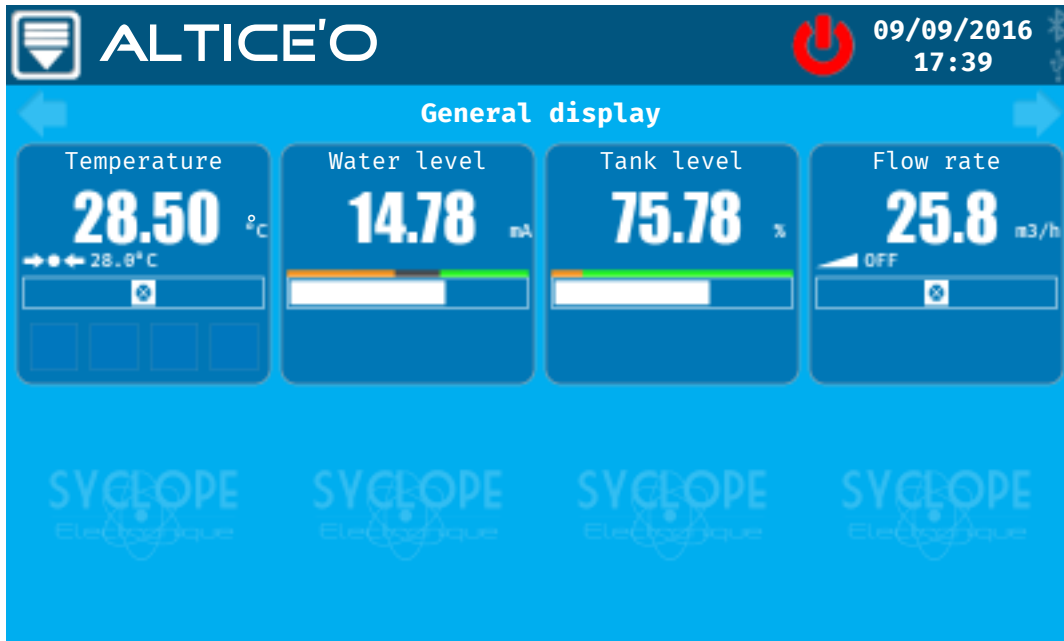

#### b) "Large thumbnail" channel display modes

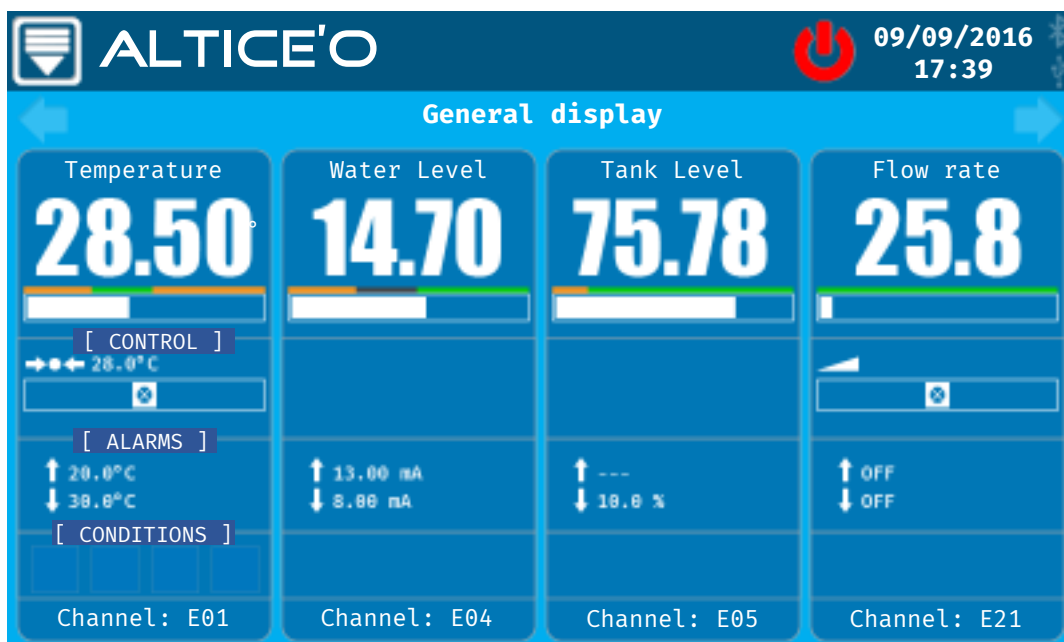

Refer to the programming instructions for selecting the display mode of the main screen and the channels to be displayed.



a) Headband

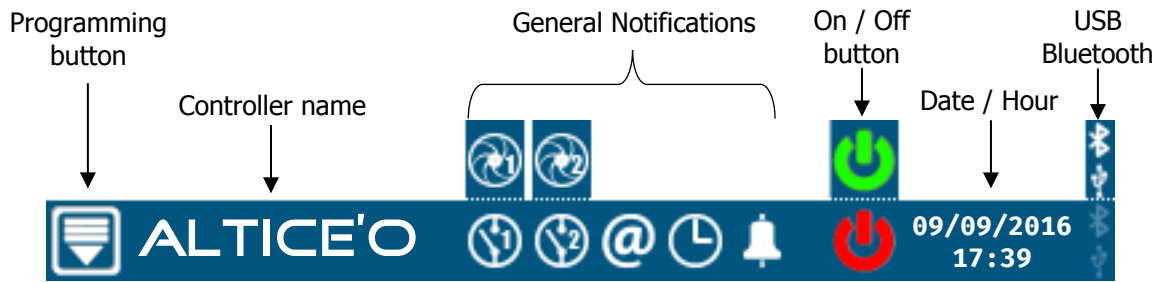

Programming button - Press to open the menu

**General Notifications**



Contact input on CAD1 active \*



Input flow on CAD1 lower than programmed low flow threshold \*



Contact input on CAD2 active \*



Input flow on CAD2 lower than programmed low flow threshold \*



Controller connected on Mysyclope.com website



One of the controller timers is active



One of the alarms on one channel is active

\* These icons may flash when a reactivation timeout is in progress. The state of the input is physically restored but the system waits for the end of the programmed time before taking into account the recovery.

**General On / Off button**



Controller on - Press to turn controller off

Controller off - Press to turn controller on

**USB & BLUETOOTH Notifications**



No USB flash drive connected



USB flash drive connected



Bluetooth not connected



Bluetooth connected

c) Changing channels display

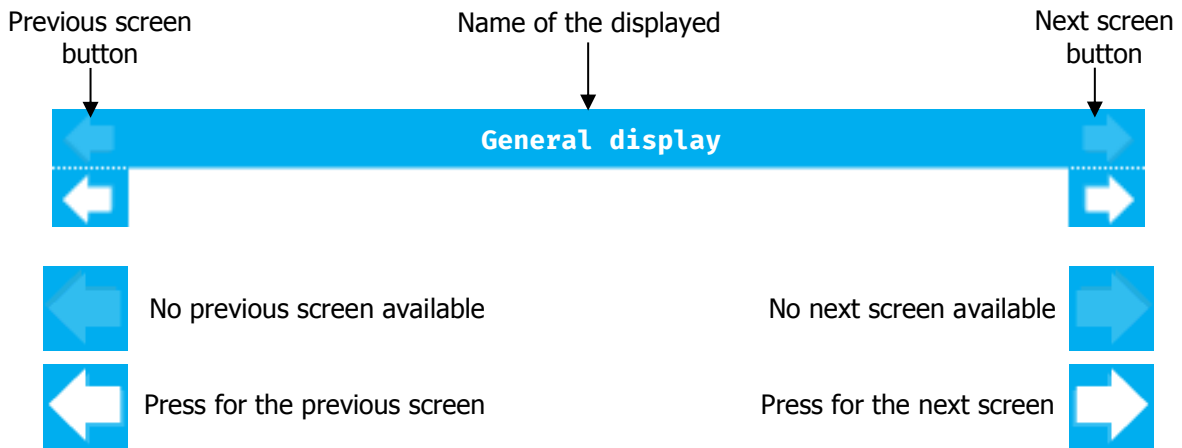

These arrows are accessible if several display screens are programmed



The name of the screen may be followed by partial display information (1/2) for example. This case occurs when there are more channels to display than can be displayed on a screen.

d) "Small Thumbnail" Channel Display Details

**Measurement channel**

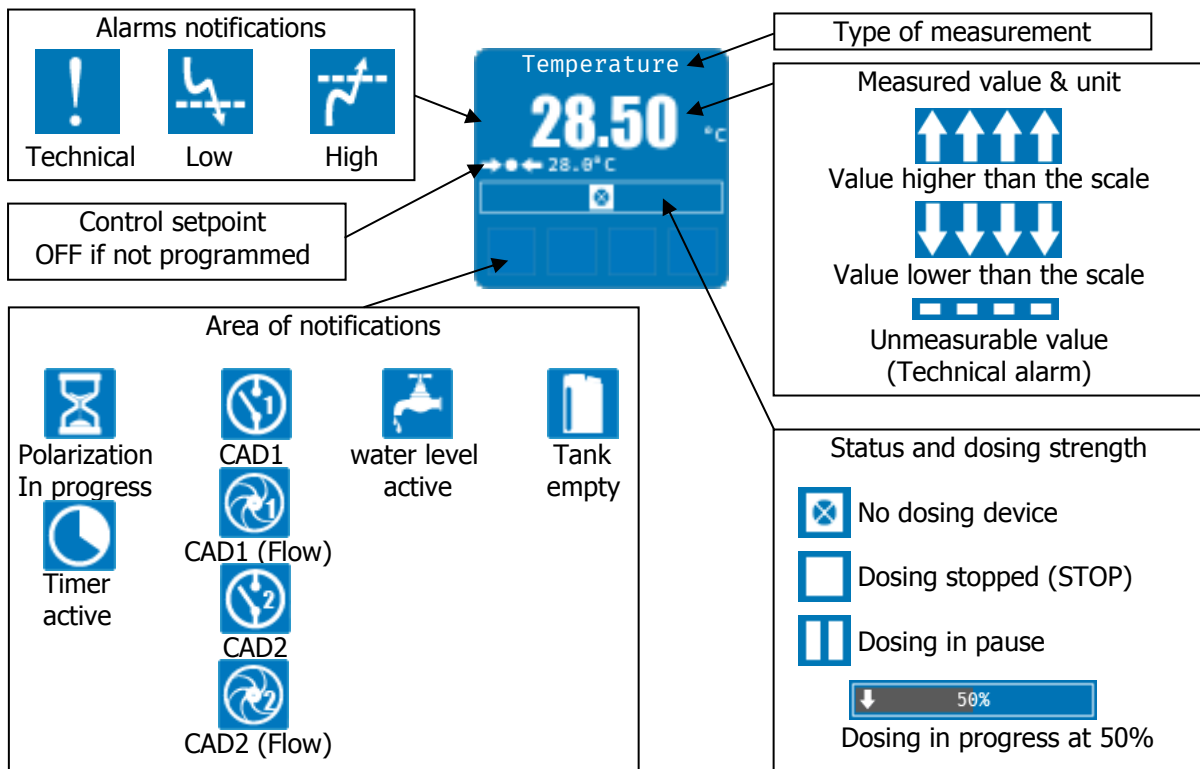

**Water level channel**

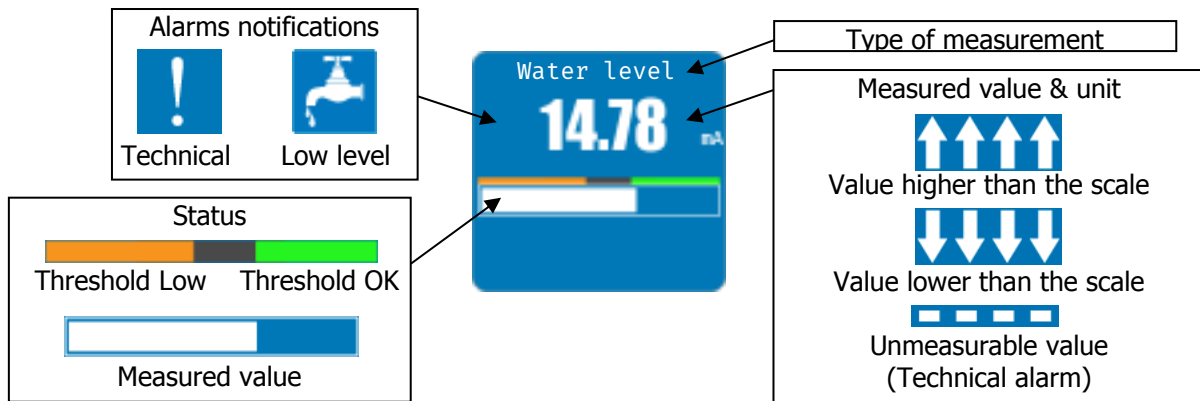

**Tank level channel**

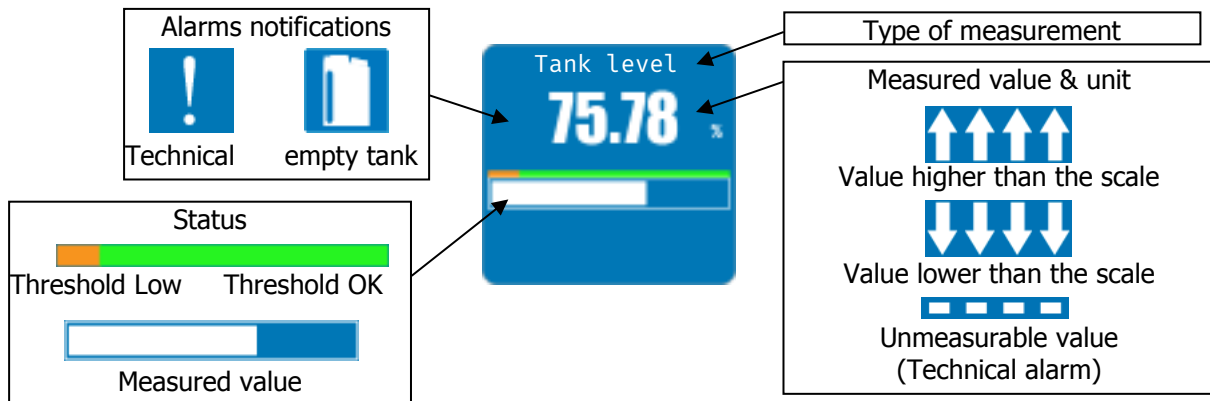

**Flow rate Channel**

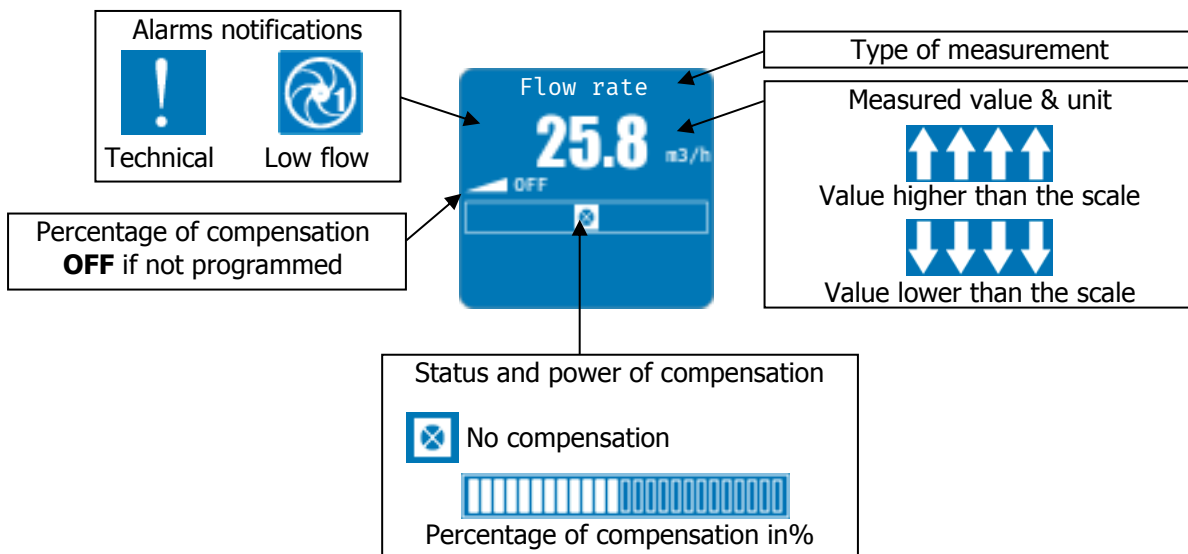

e) "Large Thumbnail" Channel Display Details

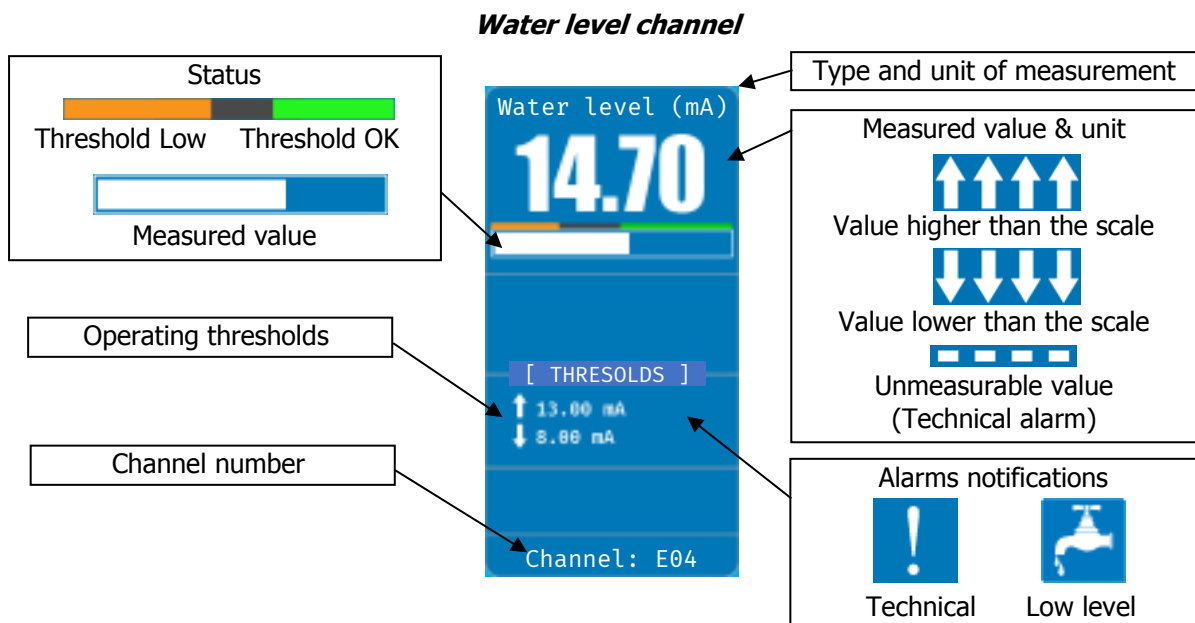
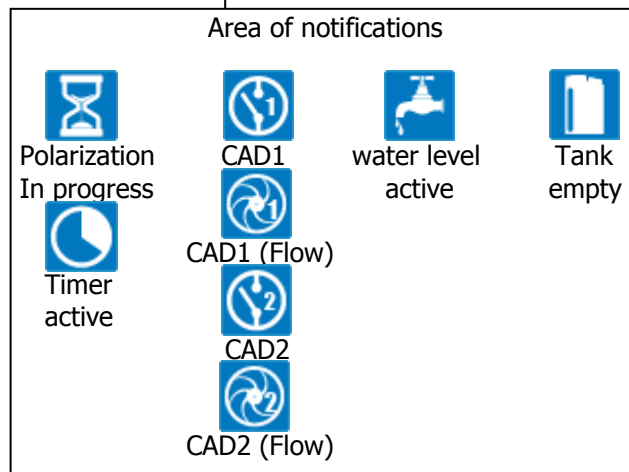
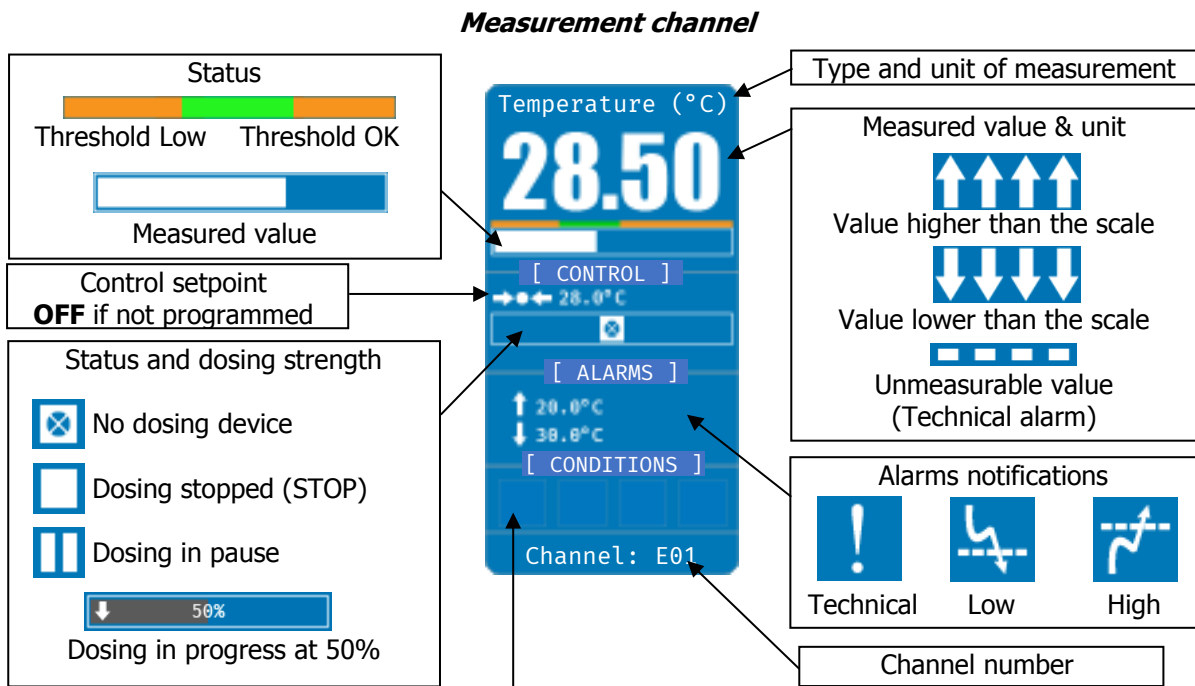

**Tank level channel**

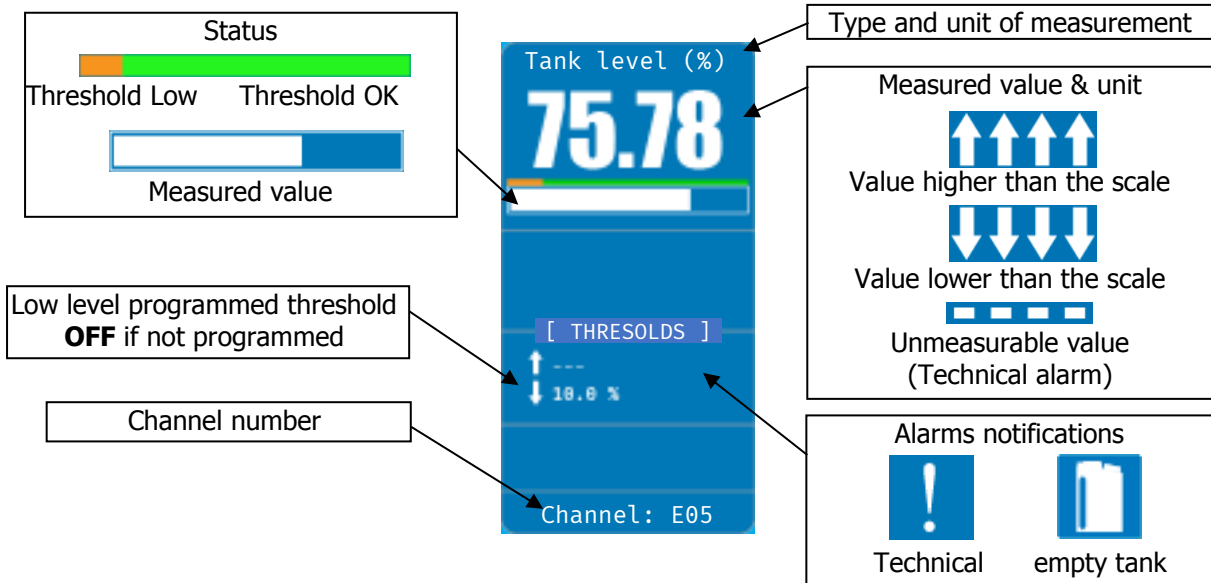

**Flow rate Channel**

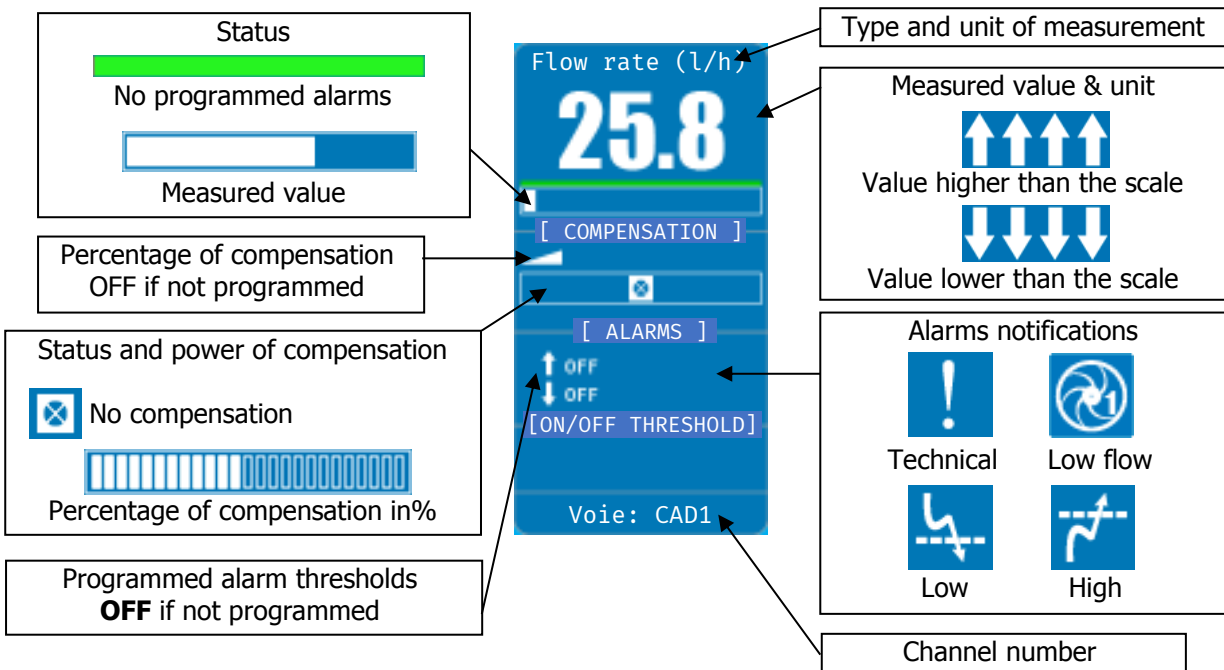

2) "Detailed" display of a channel

1. Measurement screen

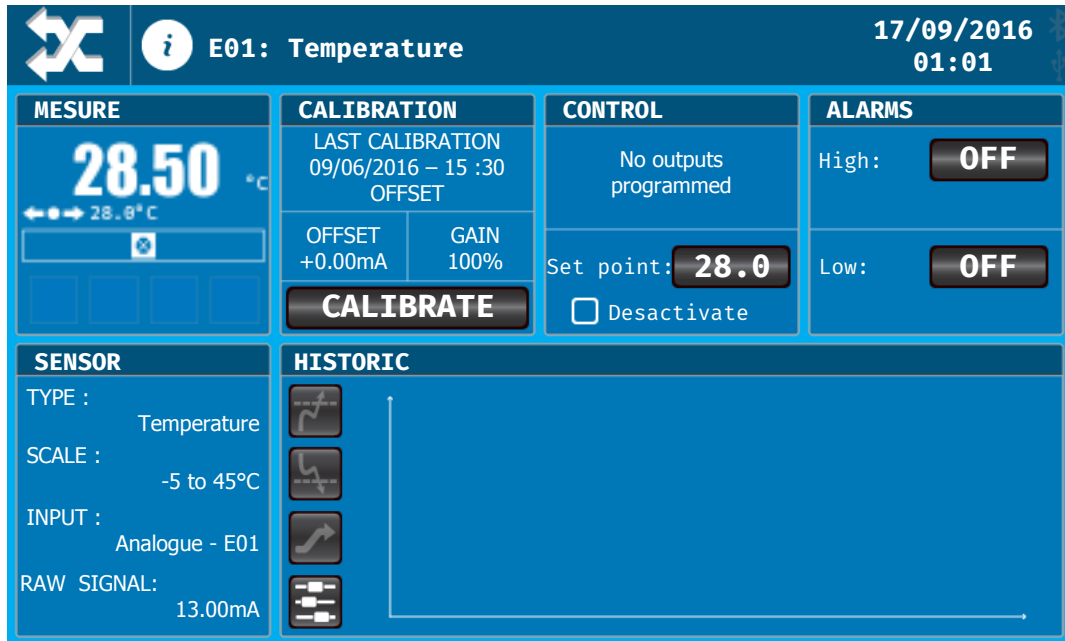

To display this screen you must press a thumbnail of the desired channel on the main screen.



The screen may change depending on the type of channel displayed, the "CALIBRATION", "CONTROL" and "ALARMS" sections/thumbnail may be different.

2. Headband detail screen

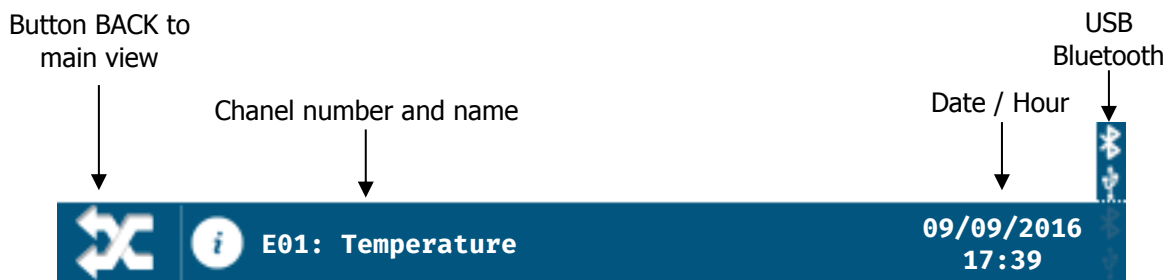

Button BACK to main view – Press to go back to the main display

**USB & BLUETOOTH Notifications**



No USB flash drive connected



USB flash drive connected



Bluetooth not connected



Bluetooth connected

3. Thumbnail "Measurement"

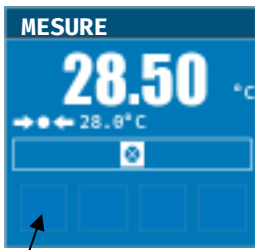

This thumbnail is the real-time state of the selected channel.

The information displayed is the same as the "Thumbnail" channel display mode.



Special case for the polarization time delay of a measurement channel. During this delay it is possible to cancel it by pressing the button with the hourglass from the detail window of the channel.

4. Thumbnail "CALIBRATION" & "COMPENSATION"

**Measurement channel**

Offset of the measuring channel.  
This value corresponds to the zero offset  
0 mA = Factory Calibration

Press to open the calibration window  
See: IX.1d

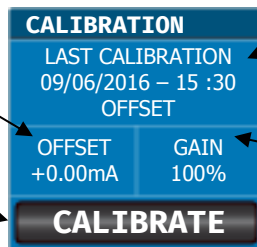

Information on the date and type of previous calibration

Gain of the measurement channel.  
This value corresponds to the slope  
100% = Factory Calibration

**Flowmeter channel**

Press to enter the lower threshold of the flow compensation.  
Cf. IX.3d

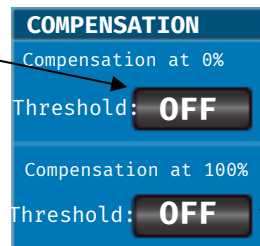

Press to enter the upper threshold of the flow compensation.  
Cf. IX.3d

5. Thumbnail "CONTROL" & "THRESHOLD ON / OFF"

**Measurement channel**

Press disabled the control temporarily.  
Cf. IX.3b

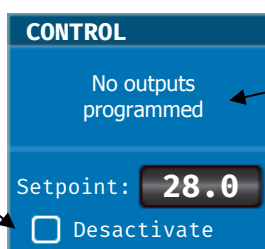

Relay or 4-20mA output information area assigned to the metering on the selected channel

Press to enter the control setpoint.  
Cf. IX.3b

**Tank level & Flow rate channel**

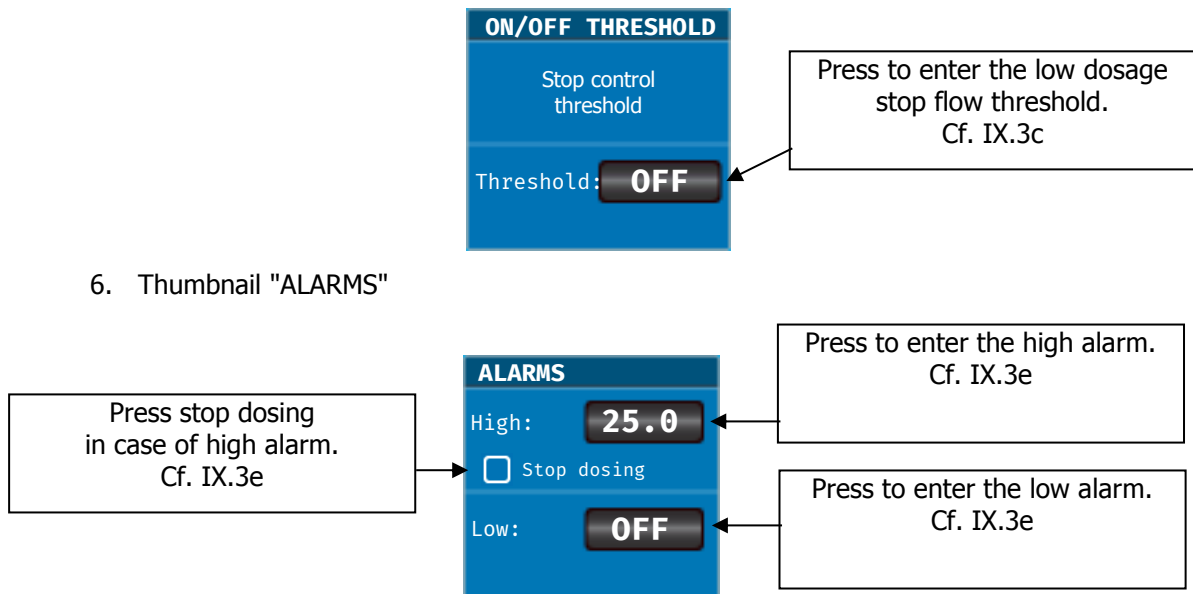

**7. Thumbnail "SENSOR" & "CALCULATION"**

**Measurement channel**

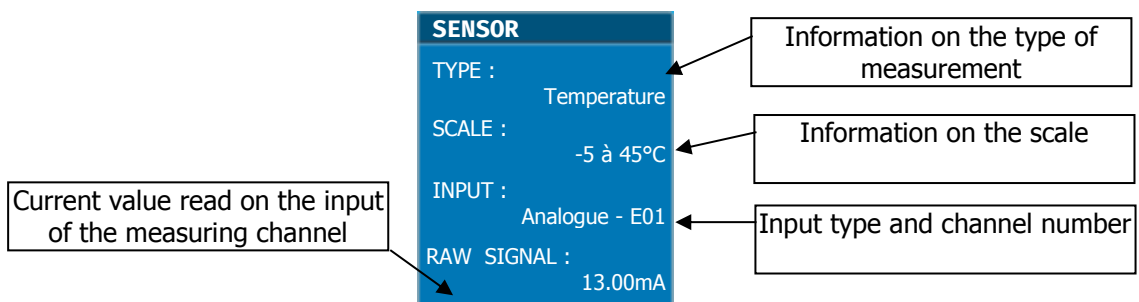

**Calculated channel**

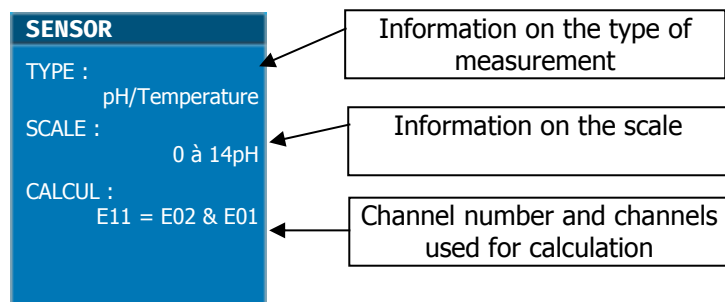

**Flowmeter channel**

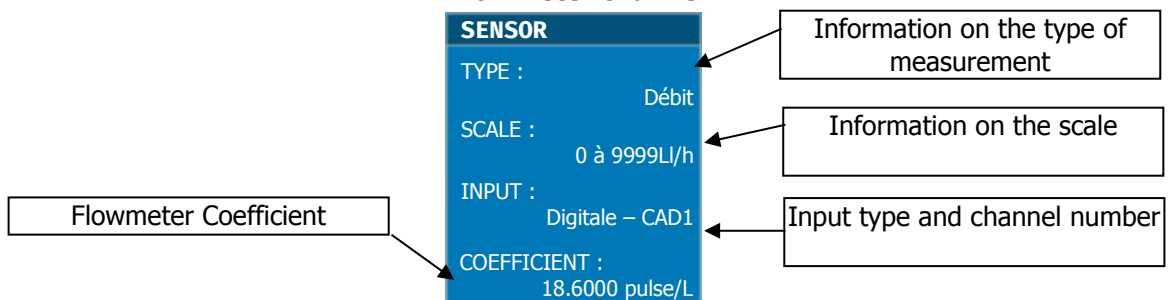



## 8. Thumbnail « HISTORIC »

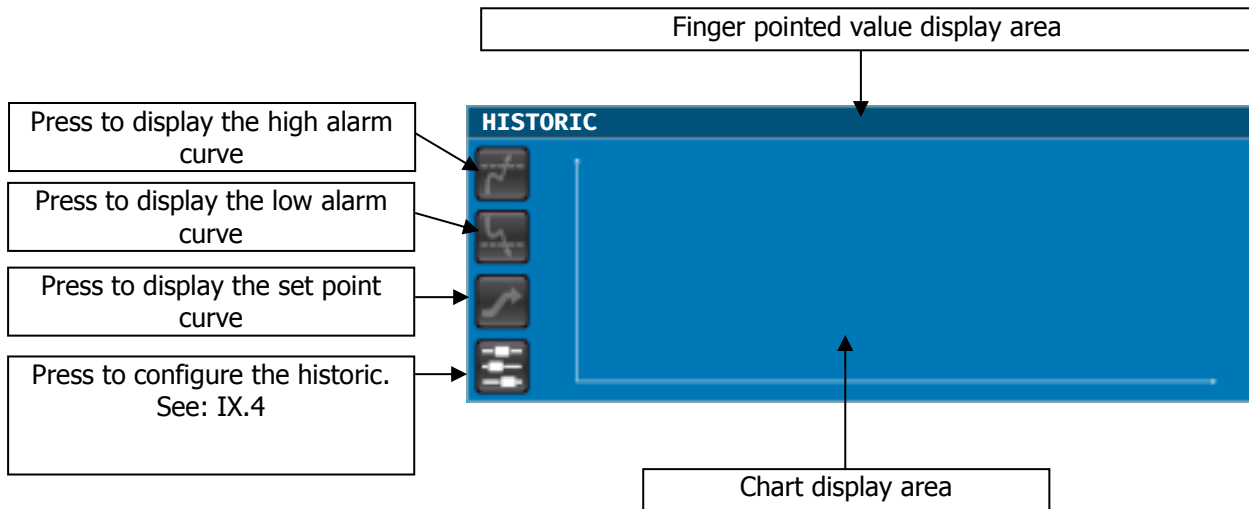

The "High Alarm", "Low Alarm" and "Setpoint" buttons can be inactive out if there are no values saved in memory.



The chart is limited to the last 470 record in memory. The time equivalence depends on the programmed recording interval.

3) Start of control and dosing

After performing all the previous programming, you are ready to start the control and dosing of the **SYCLOPE ALTICE'O®**.



Before proceeding with the control, please make sure that all the parameters and safety features stated in the documentation have been complied with.

The On / Off key



is displayed in red when the control is stopped.

The On / Off key



is displayed in green when the control is switched on.

▶ Press the key  to start the control.

▶ Check that everything goes well and that the control panel starts to regulate if necessary.

## IX. Commissioning of the SYCLOPE ALTICE'O®

You have just made the electrical connections and the connections of the various measuring and control devices, so you are ready to start up your **SYCLOPE ALTICE'O®**.



- ▶ Switch on the device.
- ▶ Check that everything went well, that your control panel is on and that the other elements of your installation have not been disturbed.



The **SYCLOPE ALTICE'O®** controller does not automatically initiate chemical treatment and dosing at power-up. The user is the only master of the start of the treatment after making sure that the control unit is programmed according to his needs.

The **SYCLOPE ALTICE'O®** controller is fully configurable. It is delivered in one of the automatic configurations (see Chapter VI, paragraph 1).

When the power is switched on, the predefined measured parameters are displayed and the control processes are inactive.



The SYCLOPE ALTICE'O® is delivered with standard programming. It is appropriate for the user to modify this programming if it does not correspond to his needs. To change the programming of your controller, please refer to the **SYCLOPE ALTICE'O®** programming documentation.

### 1) Choice of automatic configuration

As soon as the device is switched on, the start-up screen appears with the company logo SYCLOPE Electronique S.A.S. Then, the main screen with the display of the measured parameters.

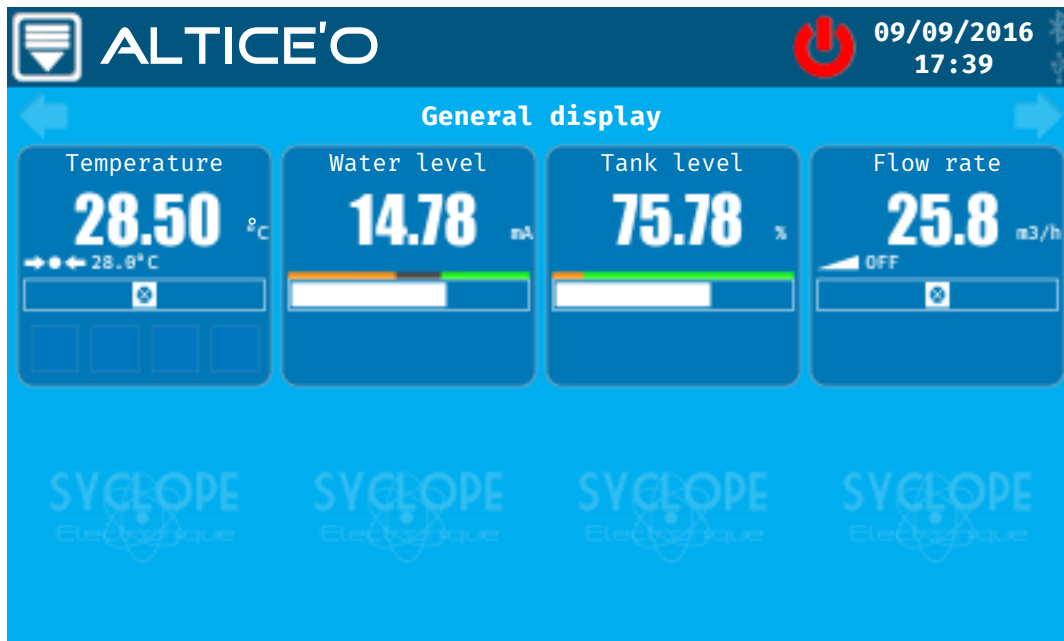

- ▶ To open the programming menu press :



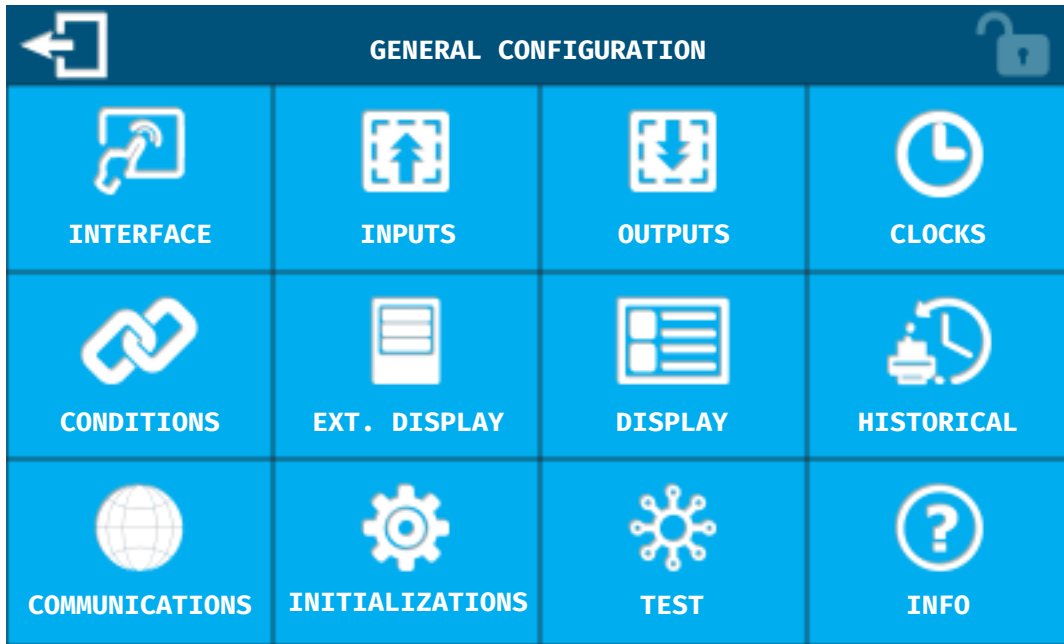

► Select the "INITIALIZATIONS" menu



► Press the button corresponding to the automatic configuration according to the needs of the site then:

The controller automatically boots according to the selected mode, the start-up screen appears a few seconds before returning to the main display.



After pressing one of the buttons and before reprogramming the whole controller, a last confirmation is requested.

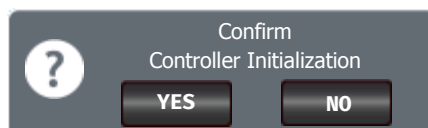

2) Programming Date/Time

► Select the INTERFACE menu

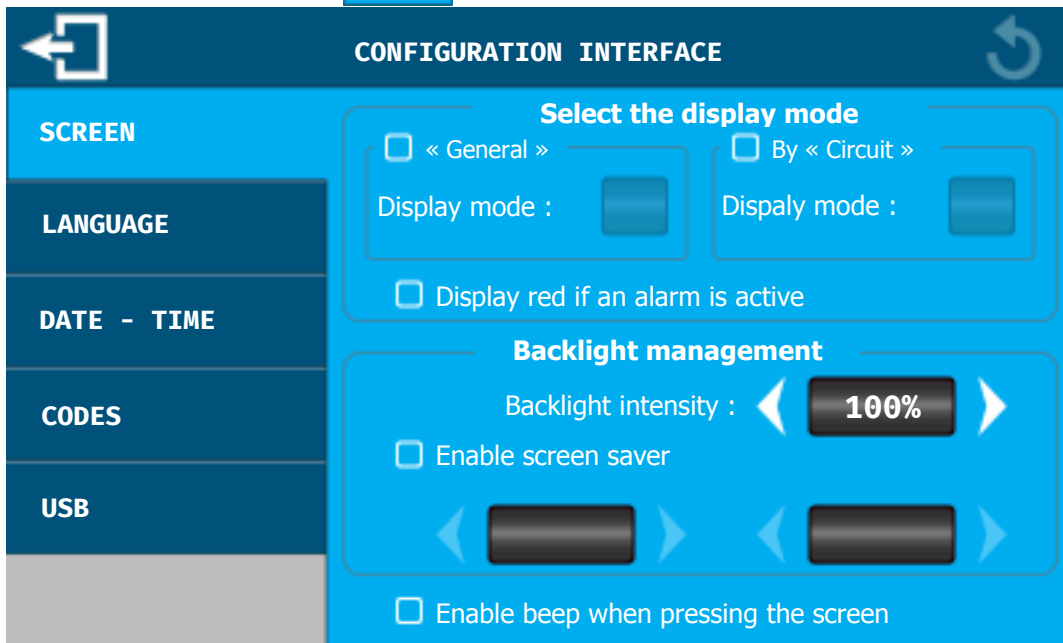

► Select the menu **DATE - TIME**

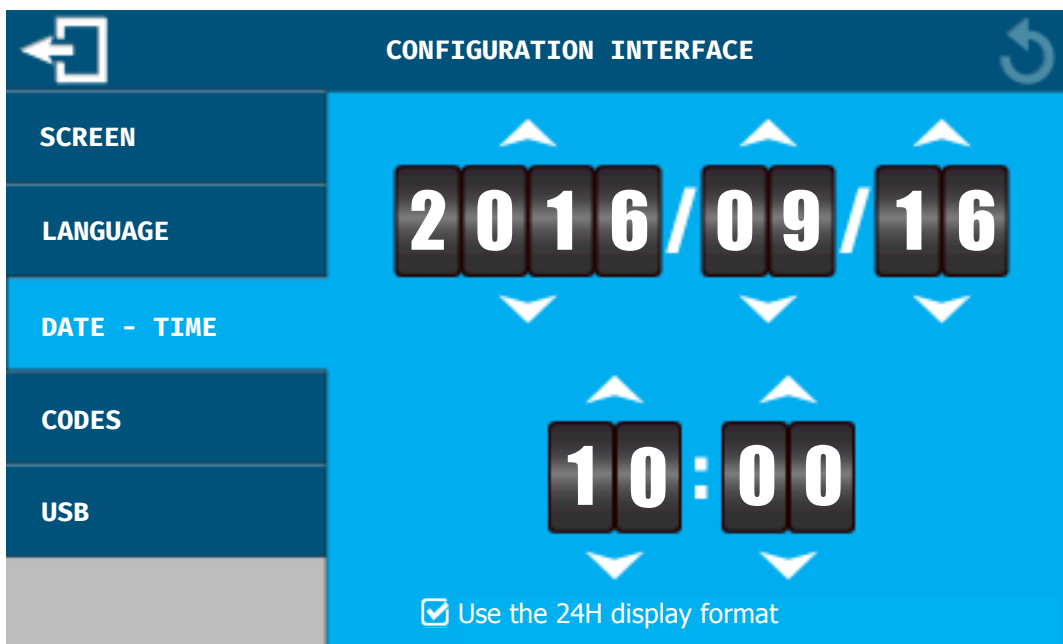

Use the arrows to change the date and time



It is possible to display the time in 12H AM / PM format by pressing the checkbox to invert the selected format.



In order for the new date and time to be taken into account and saved you must exit the programming page, changing menu or exiting the interface configuration.



You can cancel the current change before exiting to abort the change of date and time.

3) Programming setpoints, alarms and calibration

a) Access to the channel management screen

► Go to the main screen, displaying the channel to be set

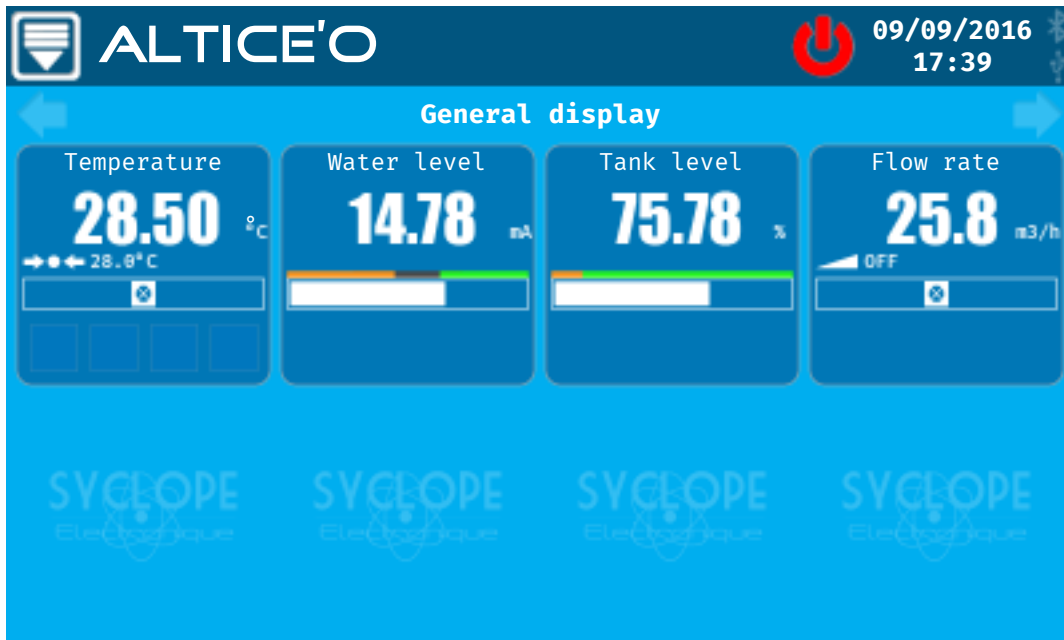

► Press the thumbnail of the selected channel

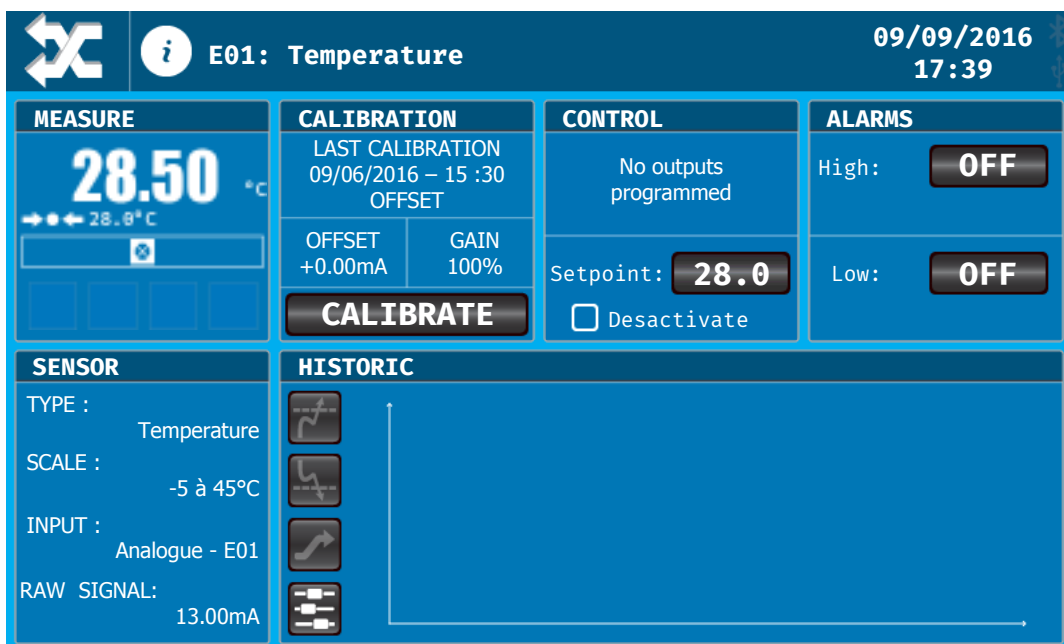
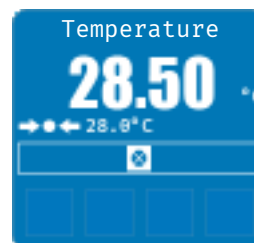

b) Programming setpoints



Improper programming of a set point can be hazardous to human health and the safety of your pool equipment. In case of doubt about the dosages to be carried out, contact our technical service before any programming.



A bad setpoint can cause excessive chemical dosing and thus disrupt the environment.

- ▶ "Desactivate" the setpoint temporarily.  This function sets the dosing function to STOP, to act on the measuring sensor without completely stopping the regulator.

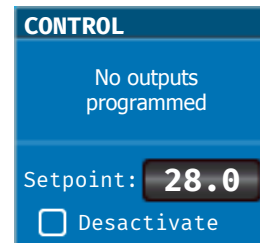

- ▶ Press the "Setpoint" button of the CONTROL thumbnail.

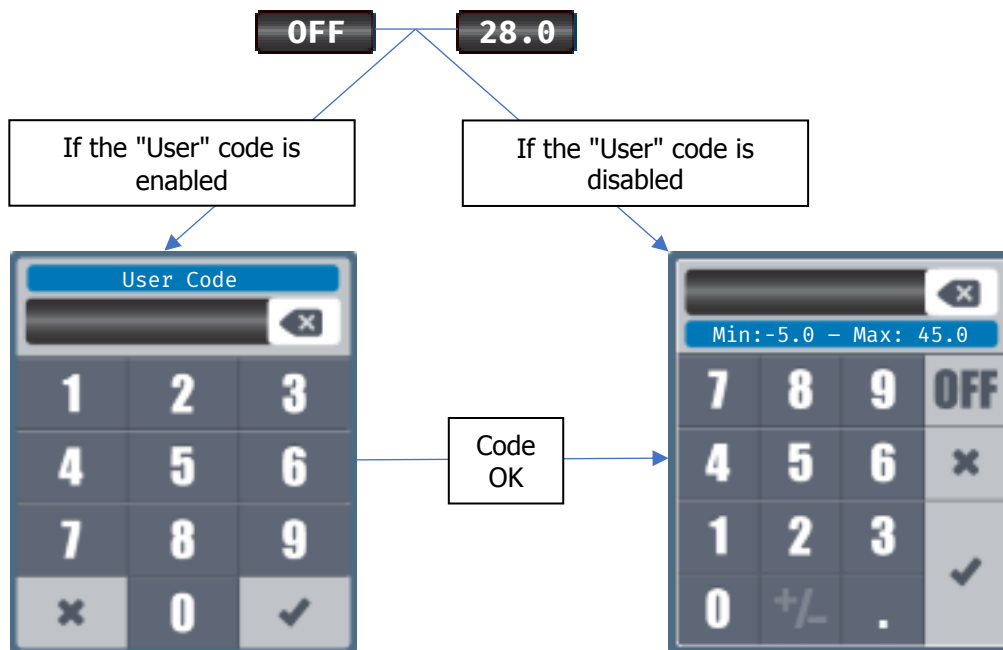

- ▶ Enter the 4-digit code and confirm.
- ▶ Enter the new setpoint and validate
- ▶ Repeat the same procedure for all other setpoints.



Refer to the programming instructions for details on how to use the password entry windows and a numeric value.

c) Programming of the metering stop threshold on a flowmeter

This threshold allows to stop dosing on the measuring input controlled by the flow rate selected.



Refer to the programming instructions for setting the remote control of the circulation flow.



► Press the "Threshold" button on the thumbnail threshold ON / OFF.

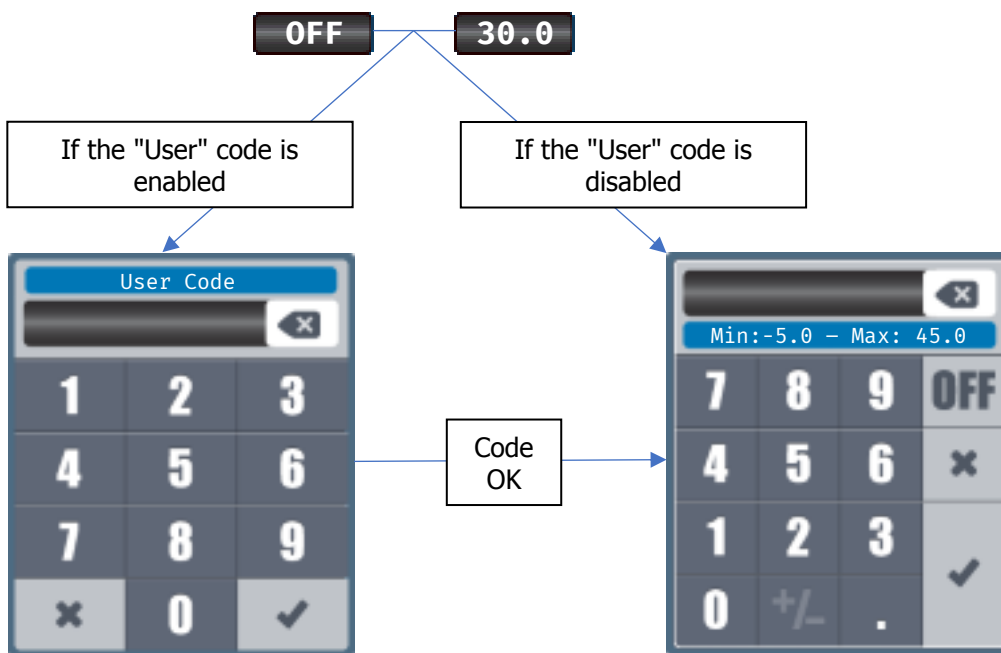

► Enter the 4-digit code and confirm.

► Enter the new threshold then validate

d) Programming of the metering stop threshold on a tank level input

This threshold allows to stop dosing on the measuring input controlled by the tank level selected level. This value corresponds to XX% of the volume of the tank from which the dosing should be stopped.



Refer to the programming instructions for setting the remote control of the tank level.



► Press the "Threshold" button on the LEVEL thumbnail.

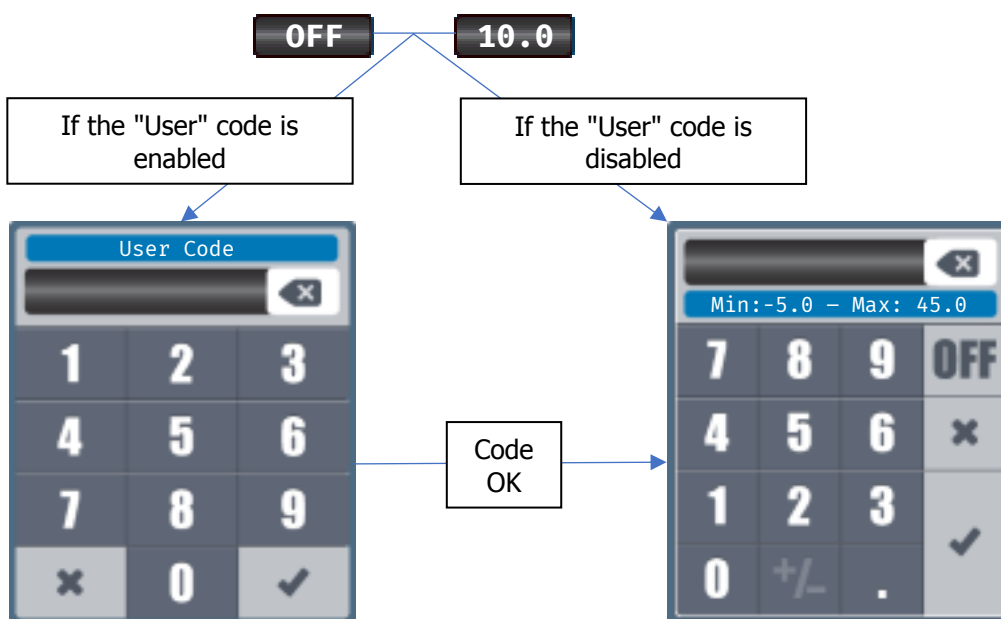

► Enter the 4-digit code and confirm.

► Enter the new threshold then validate

## e) Programming of technical alarms

In the automatic configuration, you have chosen, some relays have been programmed to prevent overruns of critical measurement thresholds (see chapter VI.). These thresholds are composed of a high level and a low level that you have the possibility to modify according to your needs.

► Stop dosing".  This function is used to program the dosing stop if the corresponding alarm is active. This option is not available if the threshold is OFF (OFF).



► Press the "High / Low" button of the ALARMS thumbnail.

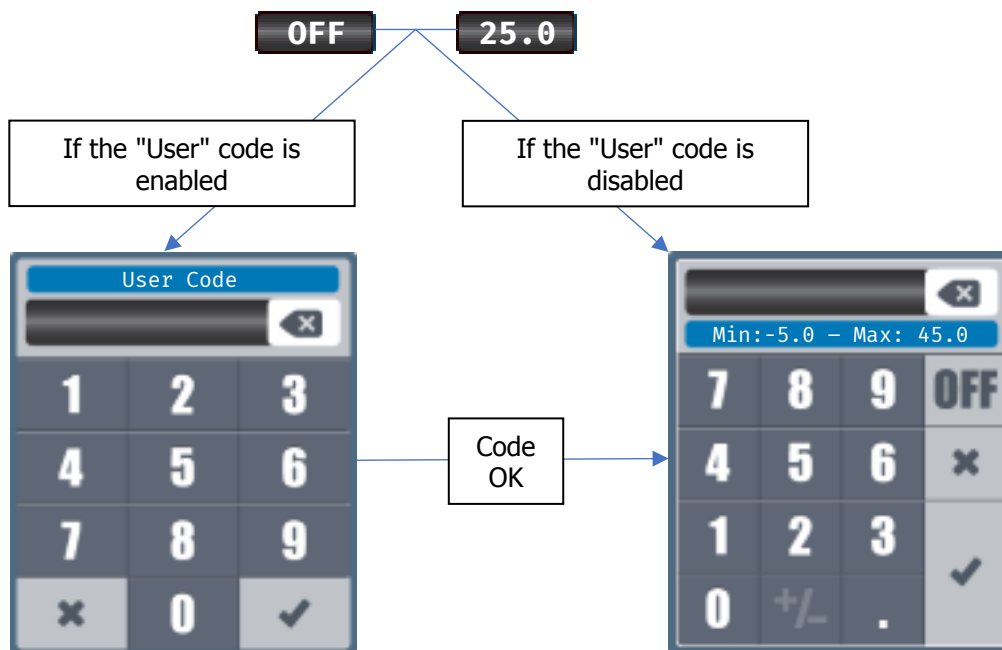

► Enter the 4-digit code and confirm.

► Enter the new alarm threshold then validate



Refer to the programming instructions for details on how to use the password entry windows and a numeric value.

► Repeat the same procedure for all other technical alarms.



f) Calibration of measuring probes



Sensor calibration is an essential part of the proper treatment of your pool. Improper calibration can be hazardous to human health and the safety of your pool equipment. In case of doubt about the manipulations to be carried out, contact our technical service before any calibration.



Bad calibration can lead to excessive dosing of chemicals and thus disrupt the environment.

► Press the "CALIBRATE" button on the thumbnail CALIBRATION.

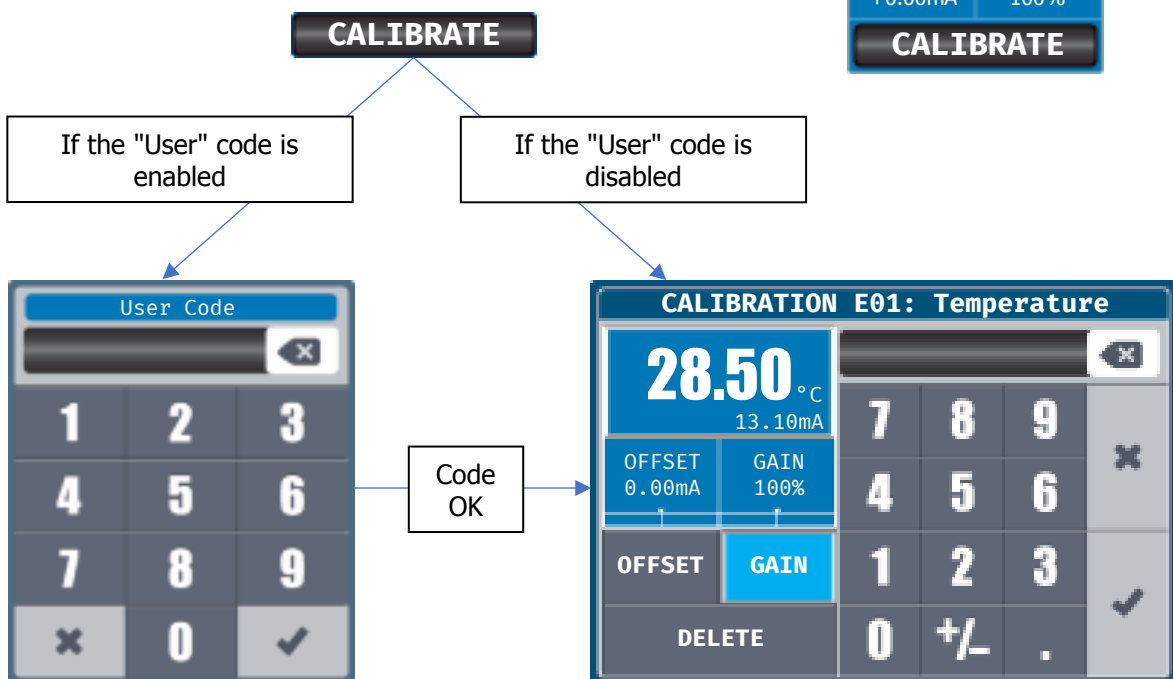

► Enter the 4-digit code and confirm.

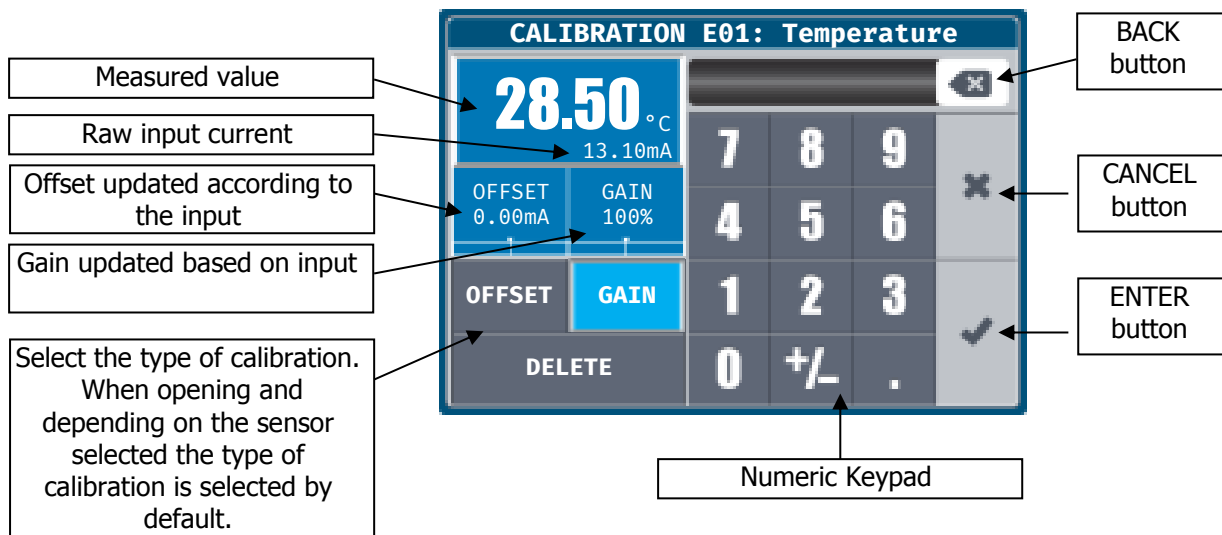

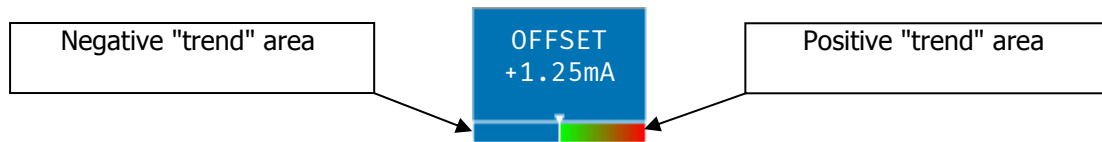

When a new value (Offset and / or Gain) is entered, a bar graph from green to red is displayed, allowing you to see the "trend" of the calibration. Calibration moving more and more in the red zone may be a sign of a problem on the sensor selected.



**WARNING :** If the entered value is too large or too low, the corresponding calibration area will be displayed in red and the validation of the value will be impossible!



It is possible to select the type of calibration by pressing the three selection buttons.

OFFSET = Offset from the zero of the measurement (summing coefficient)

GAIN = Slope of measurement (multiplier coefficient)

DELETE = Return to factory calibration of the measuring channel.



Depending on the channel type and its configuration, **SYCLOPE ALTICE'O®** controller selects the calibration function suitable for a so-called "DIRECTED" calibration. You can then enter the new value for your standard analysis.



Refer to the programming instructions for details on how to use the password input windows.

► Repeat the same procedure for all other calibrations.

#### 4) Programming the graphic historic

You can set the graphic historic by changing the display scale as well as the recording interval of the data.



Press the setting button to open the settings window.

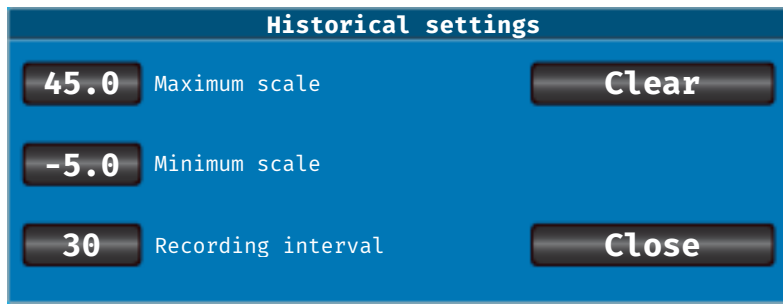

Press this button to clear the history.



Press to close this window.

► Press one of the scale buttons to change the display scale of the graph.

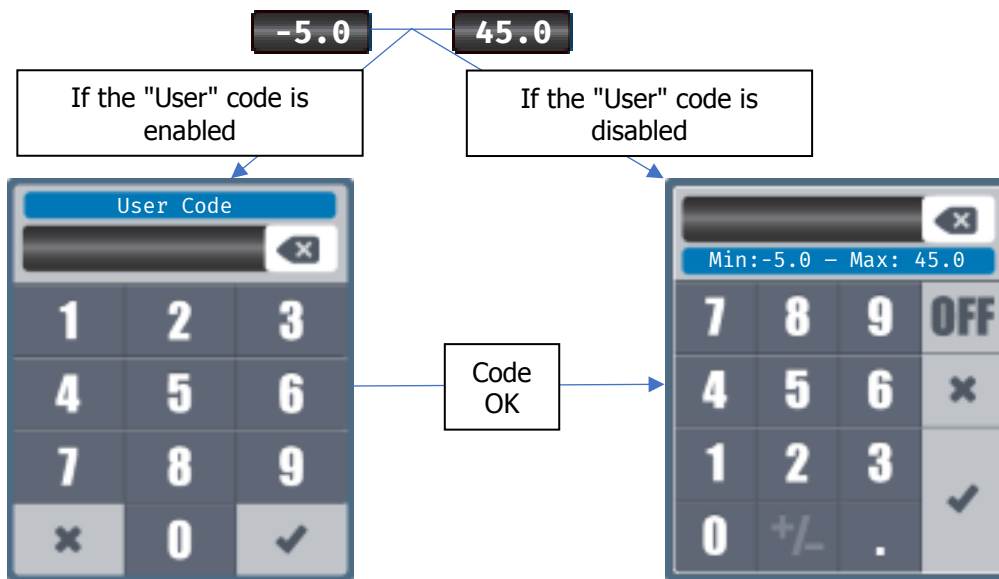

► Enter the 4-digit code and confirm.

► Enter the new scale and validate

► Press an interval button to change the recording interval in minutes.

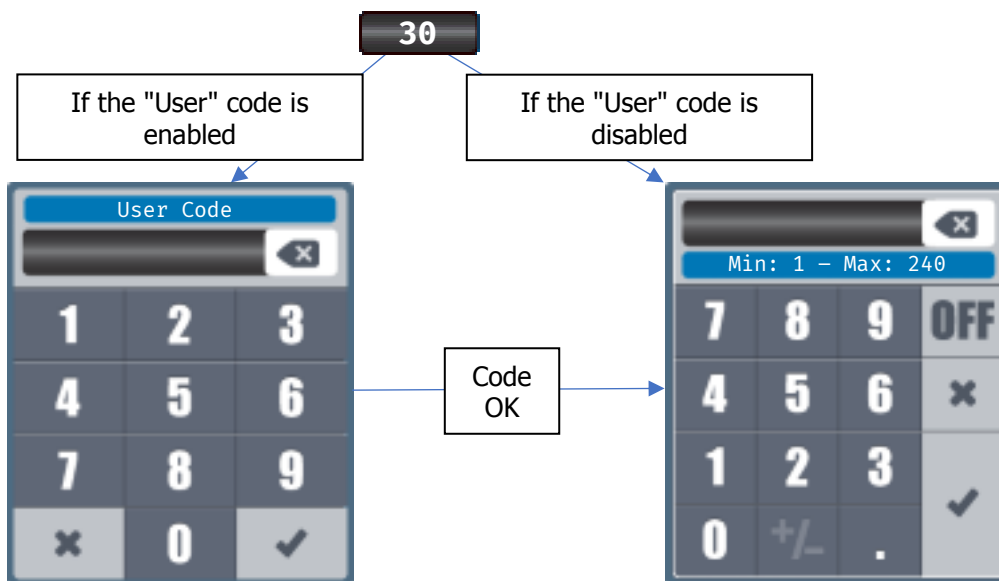

► Enter the 4-digit code and confirm.

► Enter the new interval and validate

## X. Spare parts and accessories

Reference	Name
FUS5X20T315	Time lag fuse 315 mA 5x20
EVAMICRO	Bas board "EVAMICRO"
FAC0000	Complete front face SYCLOPE ALTICEO
ELC0115	Gland PG11 grey color (Quantity 5)
CME2010	Universal housing without level detector T°, pH and Chlorine Isolated 10m of cable
CMI2010	Analogue convertor for T°, pH et Chlorine isolated 10m
CAC4210	PVC housing for gravity. 2T (Pg13,5 et 1/2") + 1T (1"M) Outputs 1" M
CME4010	Universal housing without level detector 4-20/4-20mA isolated (10m of cable)
CMI3010	Analogue converter 4-20mA (chlorine, dioxide,...) / 4-20mA isolated 10m
CAC4211	PVC gravity housing. 1T 1" Sortie 1" Male
CAA2506	Free chlorine sensor 0-10ppm
CAA2507	Active chlorine sensor 0-10ppm
CAA2503	pH electrode without pressure max 0.5bars
CAA2600	ORP electrode without reference max 6bars
CAA2513	Bromine BCDMH sensor 0-10 ppm
CAA2550	Ozone sensor 0-2ppm
CBI0963	Special housing for sea water and bromine measurement 0-10 ppm 10m
OPL1010	Cyanuric acid sensor OPTILIGHT 0-100ppm (Stabilizing)
OPL1020	PHMB sensor "OPTILIGHT" 0-100ppm
CAT2600	Temperature sensor 4...20mA -5°C à 45°C PVC 1/2"M
CAA2533	pH=7 solution in flats of 50 ml
ECH1046	Sampling system 1"M x 4/6PE with filter and valve
INF1021	USB RS485 converter
KIM0000	Socket MODEM kit Phone line SYCLOPE (Modem, cable and card)
KMD0020	MODEM GSM kit with cable and antenna
KMD0030	External MODEM GSM Kit with cables and external module

*Consult us for others references.*

## XI. Maintenance.

The controller does not require any specific maintenance.

Repairs may only be performed only by qualified technicians, and must be carried out exclusively at our plant.

If you have any problems with the controller and/or chemical sensors or if you need treatment tips, do not hesitate to contact our after-sales department.

Email : [contact@syclope.fr](mailto:contact@syclope.fr)

**XII. Appendices : Connections.**

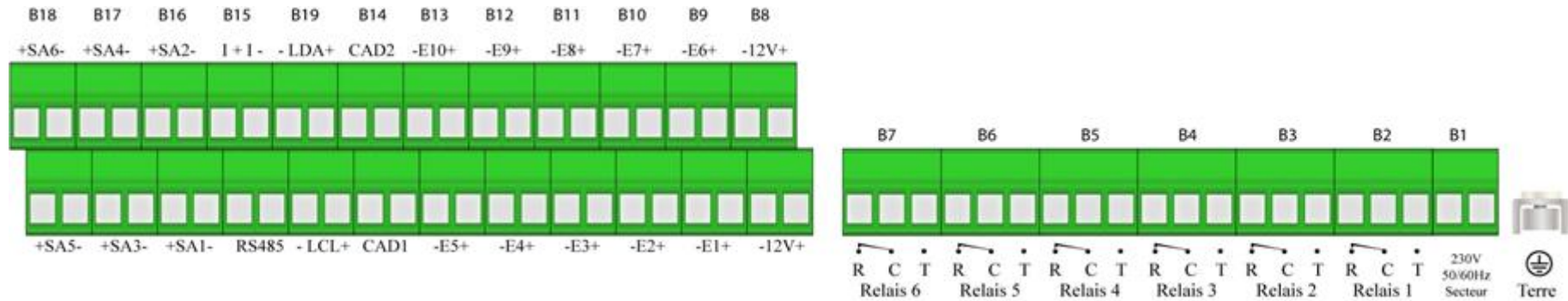

B8 (Over & under) → Supply power DC 12Volts (- +)

Inputs 4-20mA

- B9 (Under) → Inputs E1
- B9 (Over) → Inputs E6
- B10 (Under) → Inputs E2
- B10 (Over) → Inputs E7
- B11 (Under) → Inputs E3
- B11 (Over) → Inputs E8
- B12 (Under) → Inputs E4
- B12 (Over) → Inputs E9
- B13 (Under) → Inputs E5
- B13 (Over) → Inputs E10

Inputs CAD

- B14 (Under) → Inputs CAD1
- B14 (Over) → Inputs CAD2

Communication outputs

- B19 (Under) → Horloge Modules
- B19 (Over) → Data Modules
- B15 (Under) → Bus RS485
- B15 (Over) → Bus Afficheurs

Analogue outputs 4-20mA

- B16 (Under) → Output SA1
- B16 (Over) → Output SA2
- B17 (Under) → Output SA3
- B17 (Over) → Output SA4
- B18 (Under) → Output SA5
- B18 (Over) → Output SA6

B1 → Main power AC 230Volts + Ground

B2 → Relay outputs 1 (Rest - Common - Task)

B3 → Relay outputs 2 (Rest - Common - Task)

B4 → Relay outputs 3 (Rest - Common - Task)

B5 → Relay outputs 4 (Rest - Common - Task)

B6 → Relay outputs 5 (Rest - Common - Task)

B7 → Relay outputs 6 (Rest - Common - Task)

## Certificat de conformité CE

**Désignation des produits : ALTICE'O**

**Déclaration :**

Nous déclarons par la présente que l'appareil « ALTICE'O » Rev. 1, contrôleur pour l'analyse et la régulation de mesures physico-chimiques des eaux de piscines » est conforme aux exigences en matière de sécurité définies par les Directives Européennes 2004/108/CE (Compatibilité électromagnétiques), 2006/95/CE (Directive basse tension) et 2002/95/CE (Directive RoHS).

La présente déclaration est valable pour tous les exemplaires fabriqués suivant les documents de fabrication originaux.

Les normes suivantes ont été utilisées pour l'examen du produit :

- 2006/95/CE :** EN61010-1 Ed.3 : 2010  
 Directive basse tension 2006/95/CEE  
 Règles de sécurité pour appareils électriques de mesurage, de régulation et de laboratoire  
 Incluant déviations suivantes : IL, RU, US et CA  
 Rapport d'essais n° 385785-R2\_E du 10 Septembre 2014
- 2004/108/CE :** EN55022-(2006+A1:2007), EN55024(2010)  
 EN61000-4-2, EN61000-4-3, EN61000-4-4, EN61000-4-5, EN61000-4-6, EN61000-4-8,  
 EN61000-4-11, EN61000-3-2 et EN61000-3-3  
 Directive 2004/108/CE Compatibilités électromagnétiques  
 Rapport d'essais n° 385788-R1\_E du 2 au 21 Avril 2013  
**Norme harmonisée applicable ETSI EN 301 511 V9.0.2.**  
 Rapport d'essai n° 385788-R4\_E du 6 et 7 Février 2013.  
**Norme harmonisée applicable ETSI EN 300 328 V1.7.1.**  
 Rapport d'essai n° 385788-R4\_E du 6 et 7 Février 2013.  
**Norme harmonisée applicable EN62311(2008), EN50385(2002) e EN50383(2002)**  
 Rapport d'essai n° 385788-R4\_E du 21 Mai 2013.
- 2002/95/CE :** Directive RoHS (Limitation des substances dangereuses)

**Date de 1ere mise en vente : Novembre 2016**

La présente déclaration engage la responsabilité de :



**SYCLOPE Electronique S.A.S.**  
**Z.I. Aéroport Pyrénées**  
**64 230 SAUVAGNON**

Représentée par :

Georges BRETON  
 Président Directeur Général

Sauvagnon le : 10/11/2016







**SYCLOPE Electronique S.A.S.**

Z.I. Aéroport pyrénées

Rue du Bruscos

64 230 SAUVAGNON - France –

Tel : +33 (0) 559 337 036

Fax : +33 (0) 559 337 037

Email : [contact@syclope.fr](mailto:contact@syclope.fr)

Internet : <http://www.syclope.fr>

© 2017 by SYCLOPE Electronique S.A.S.